

7

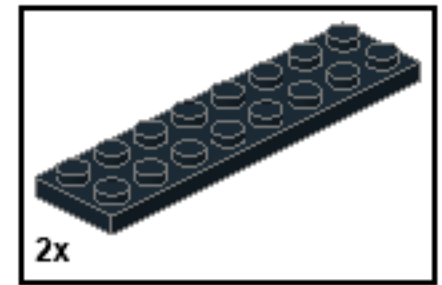

8

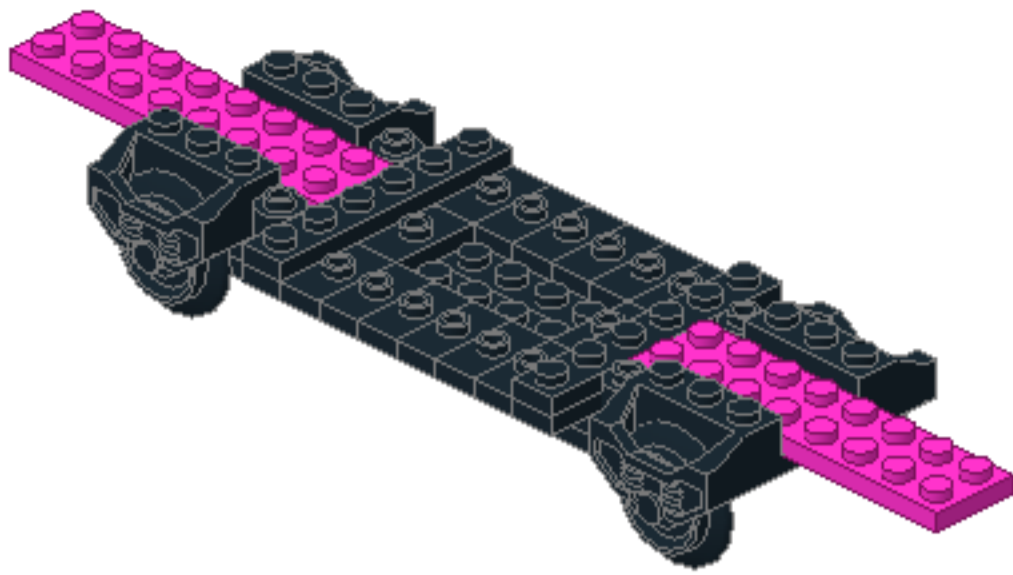
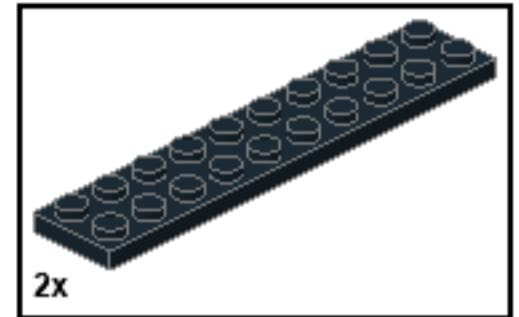
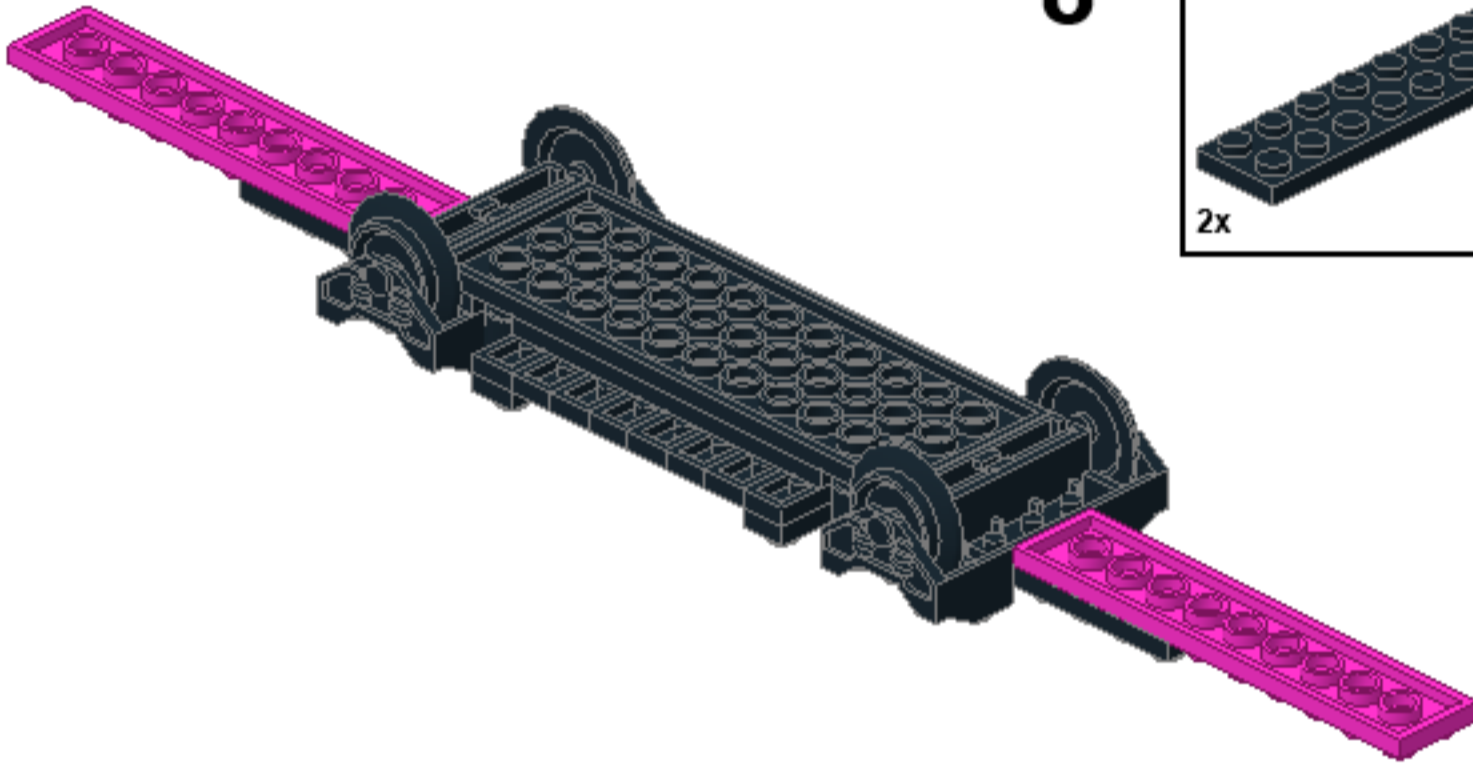

9

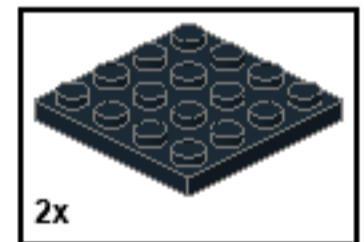
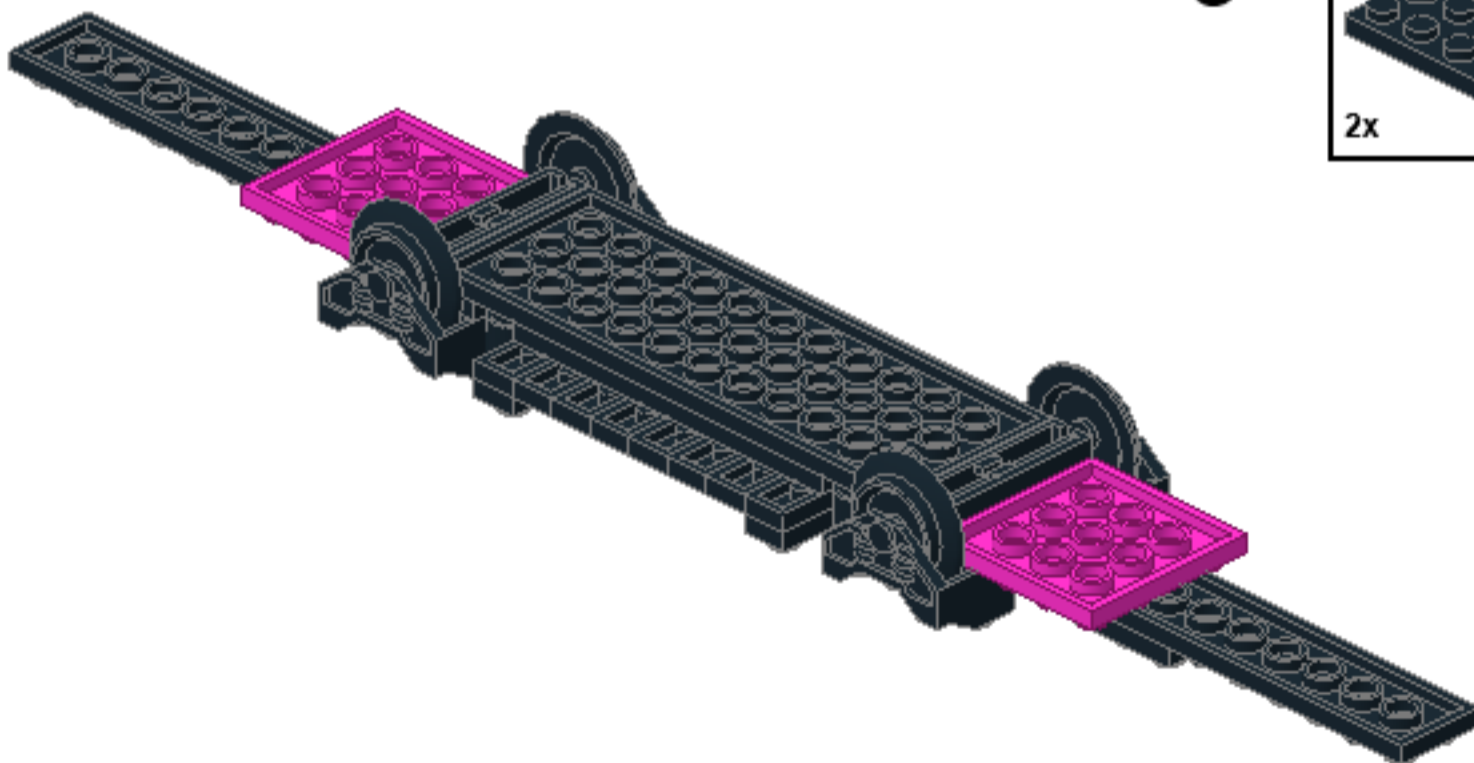

10

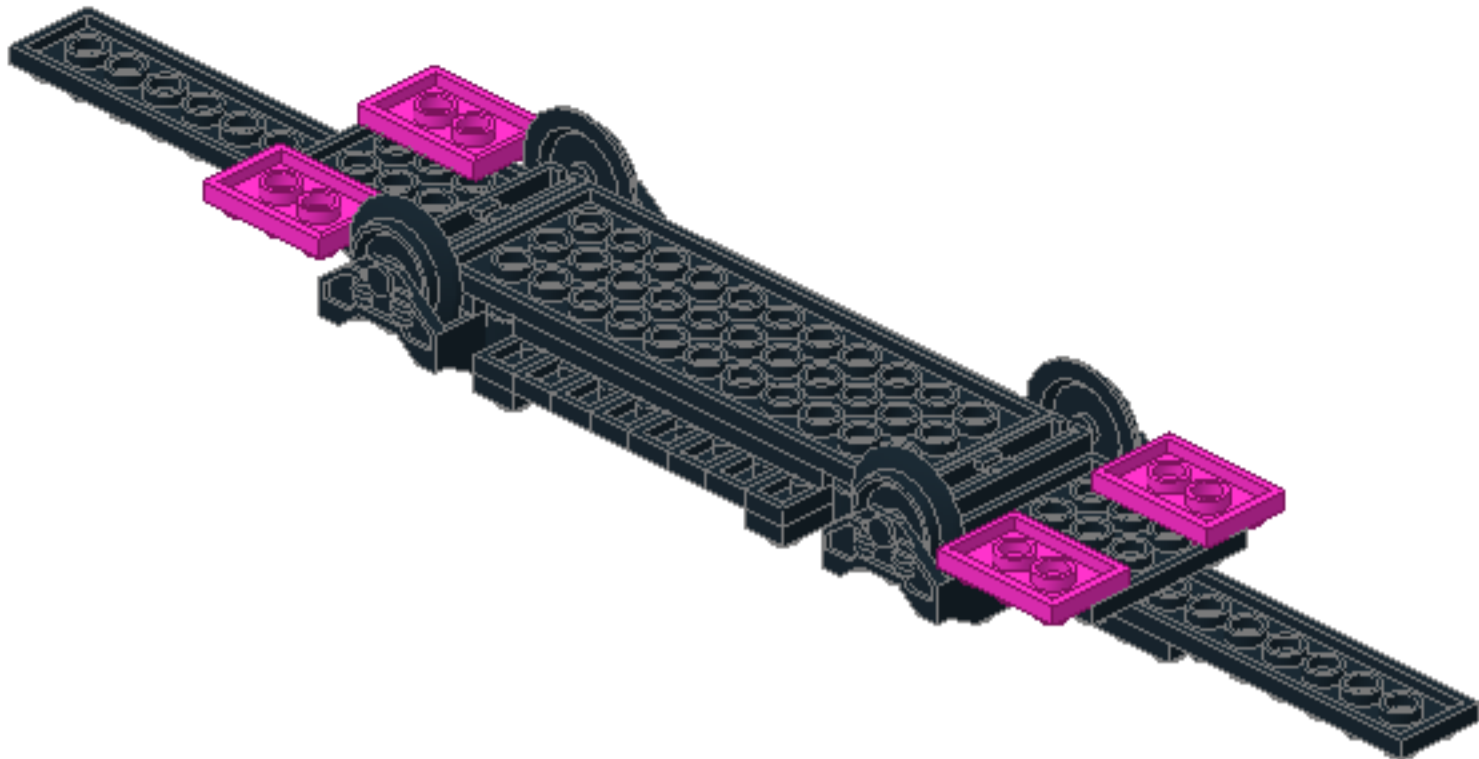
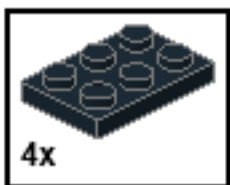

11

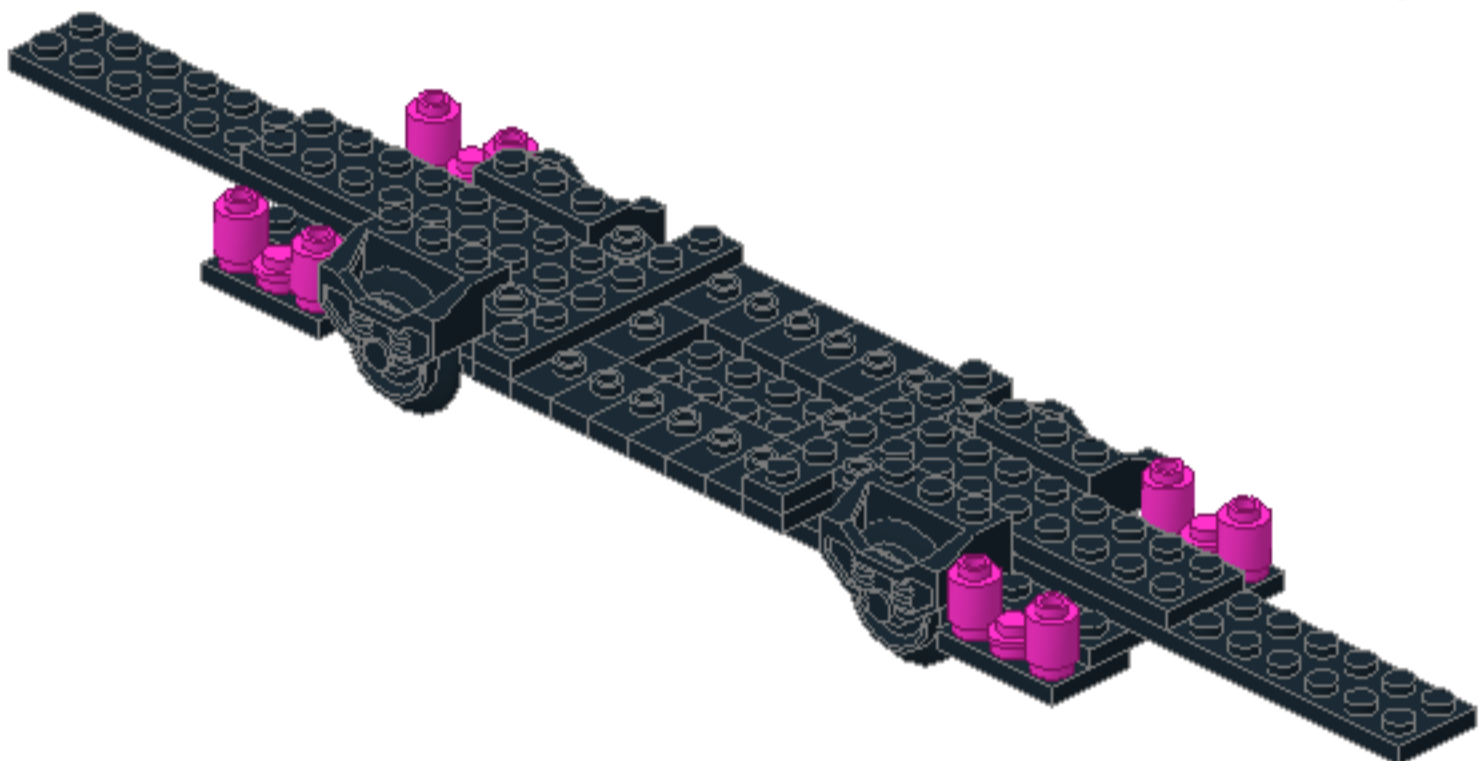

12

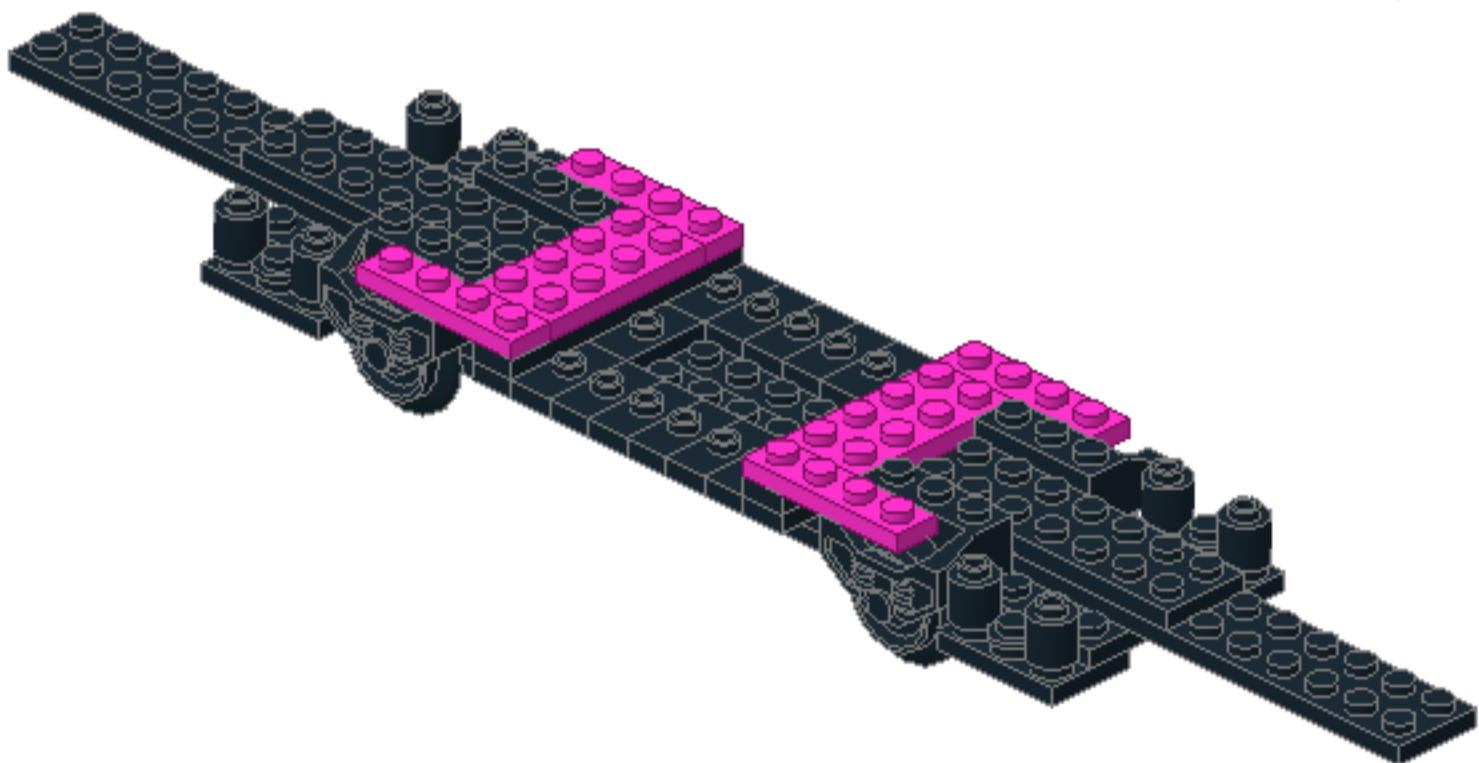
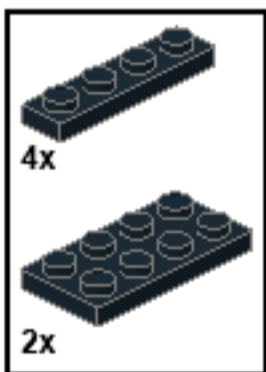

13

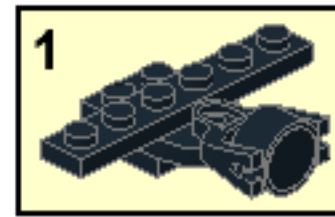
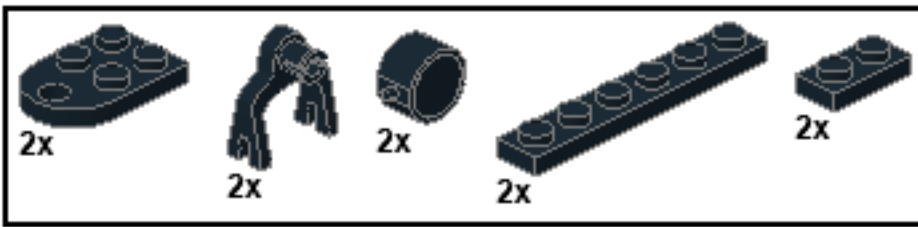

x2

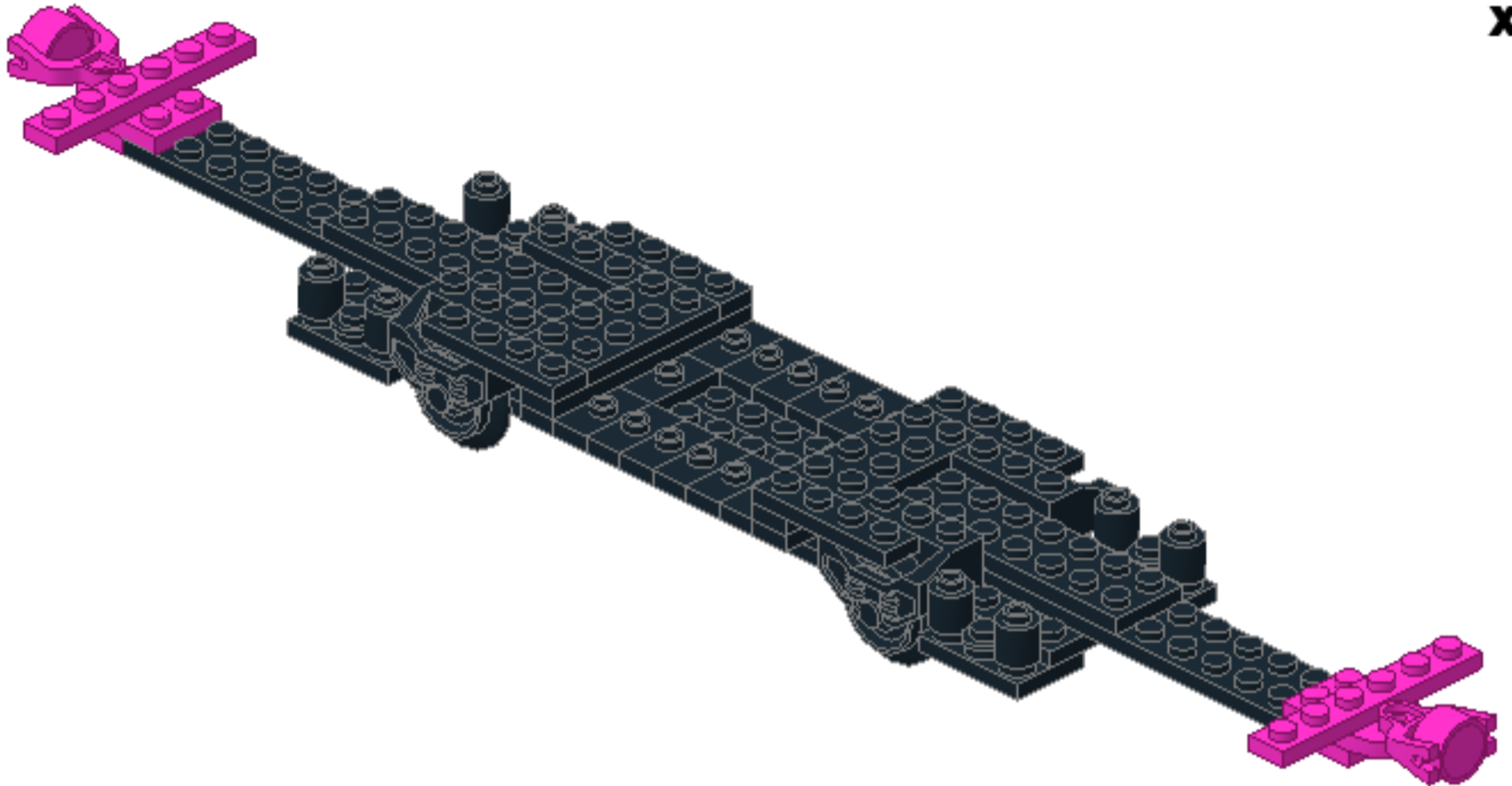

14

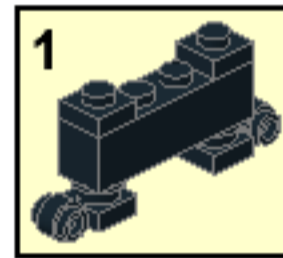
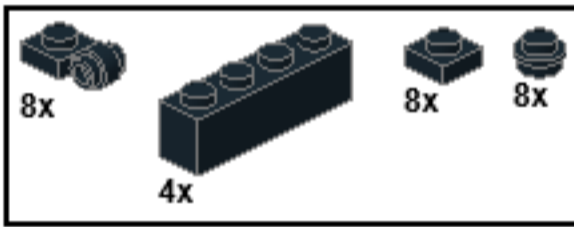

x4

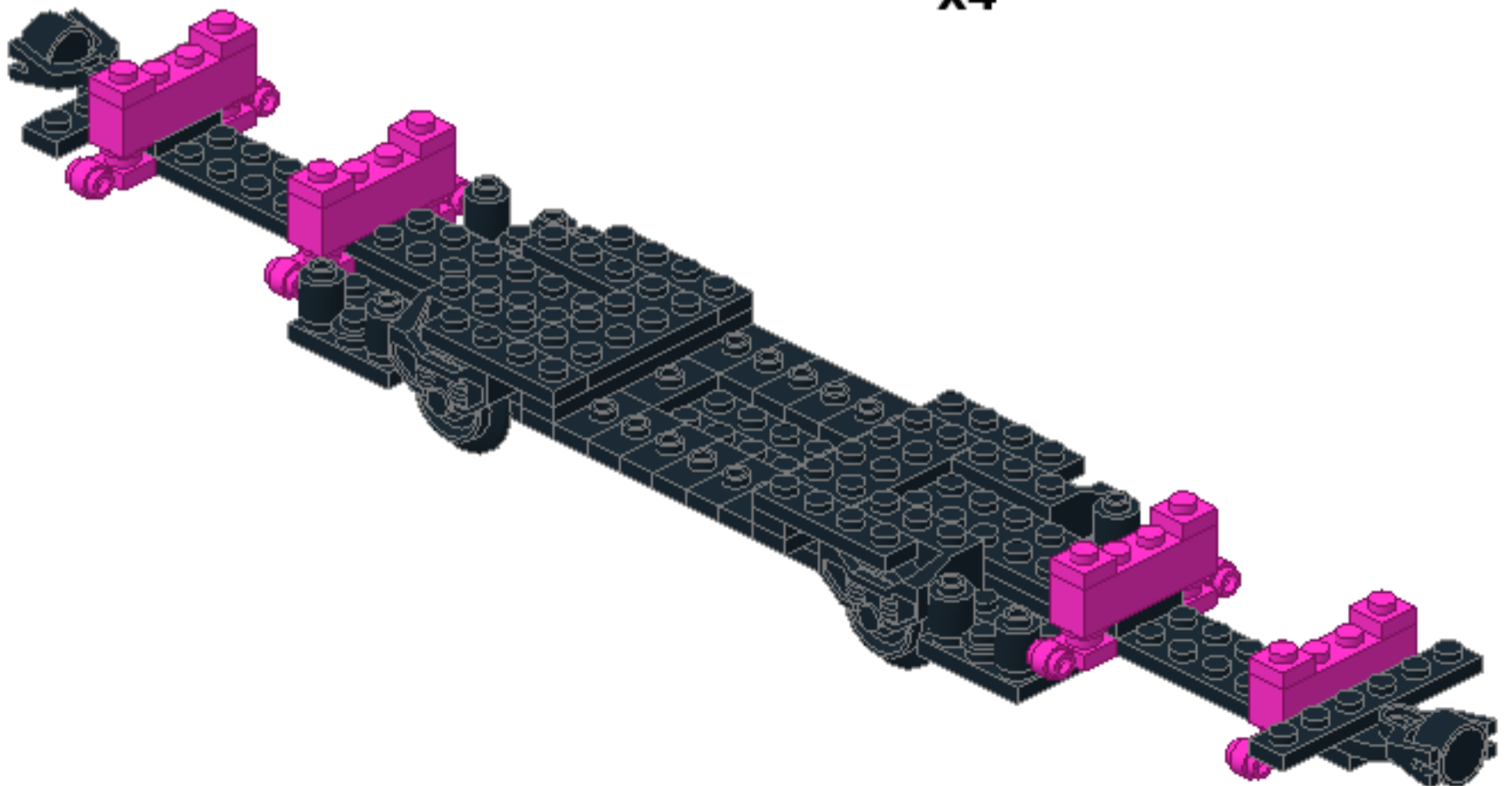

15

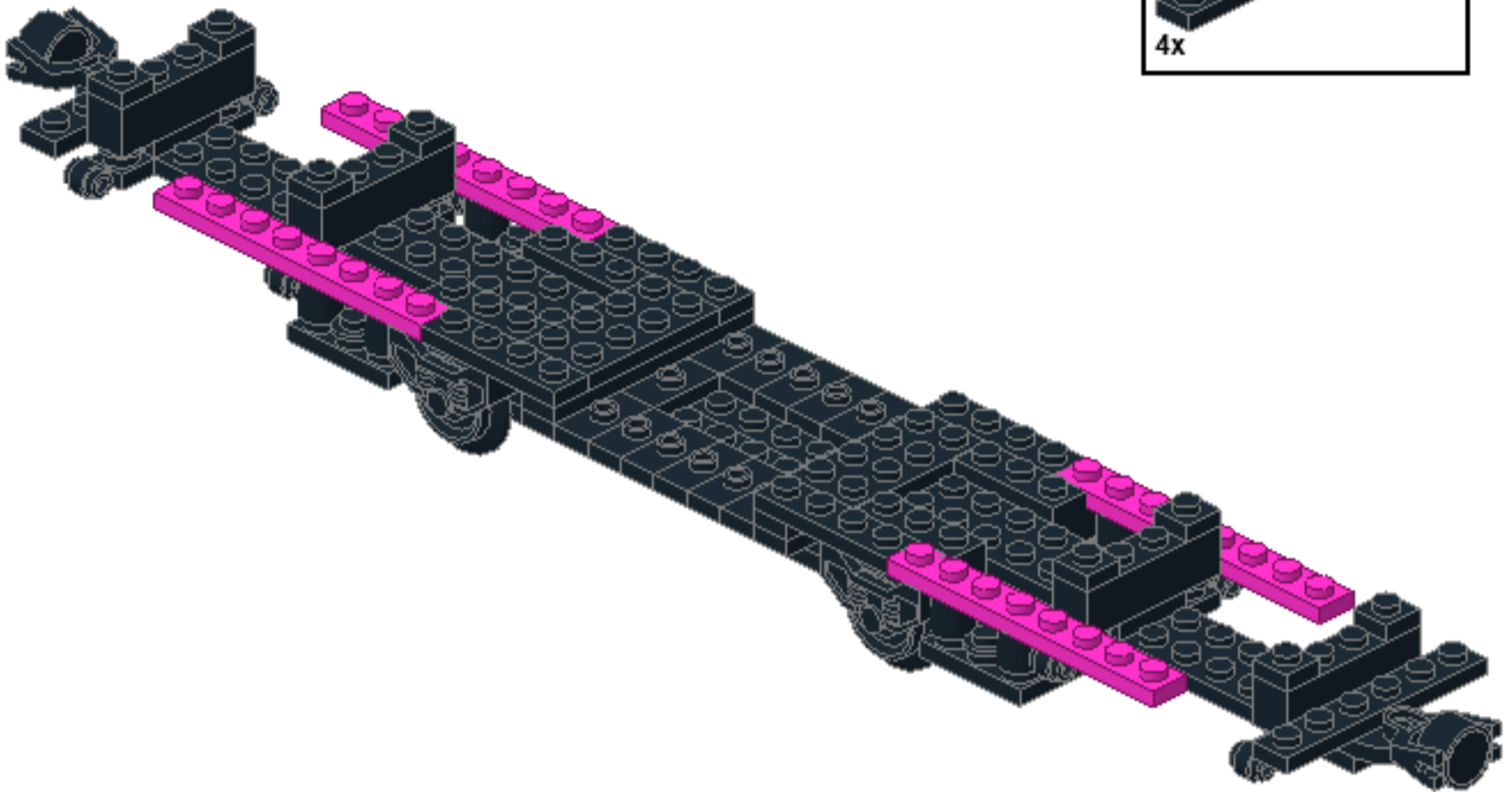
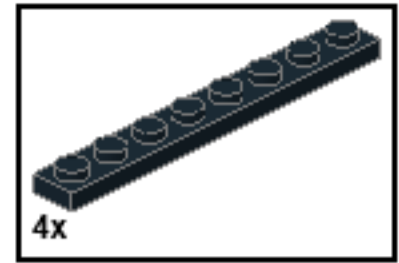

16

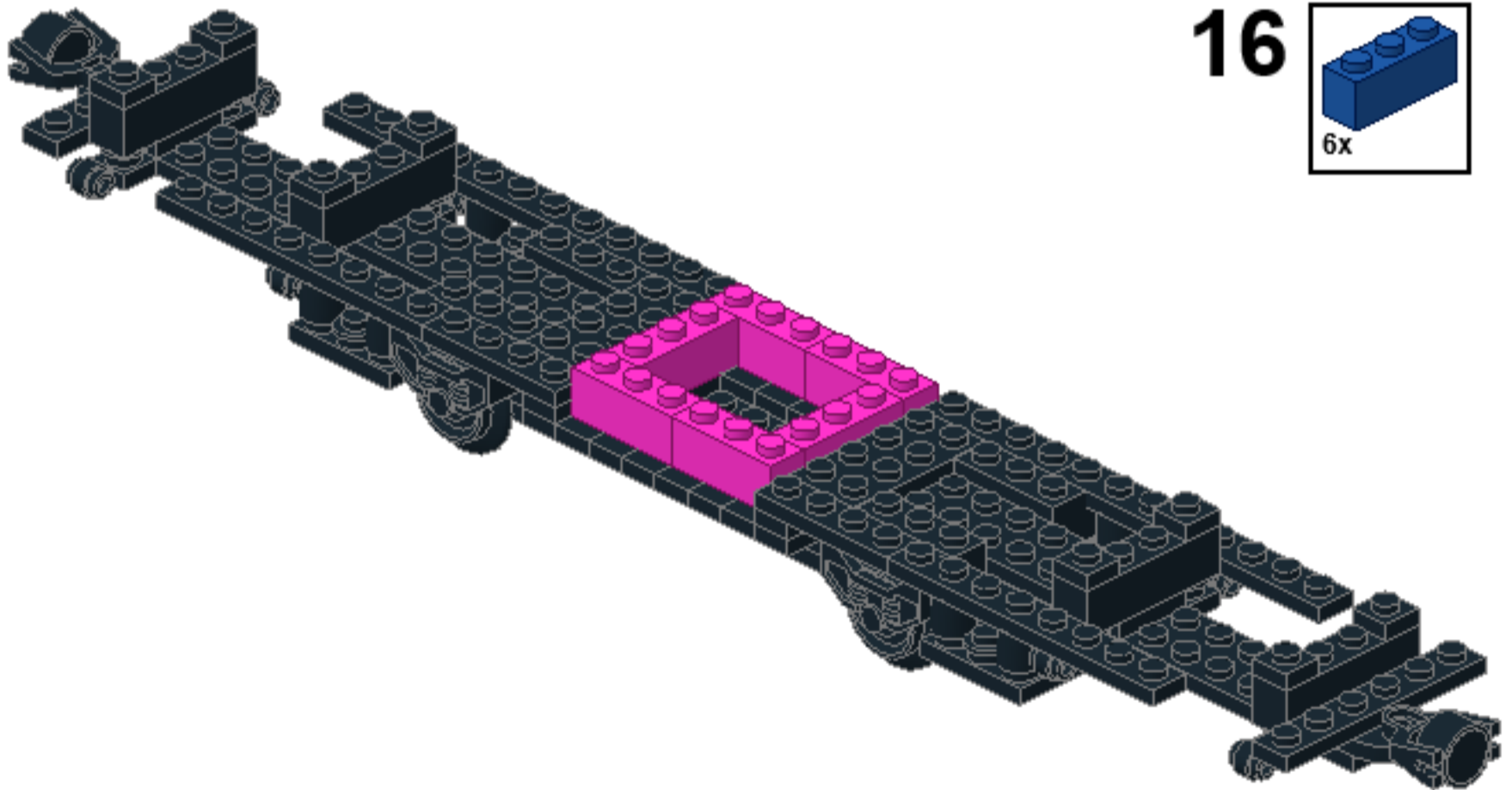
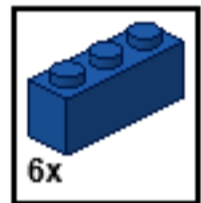

17

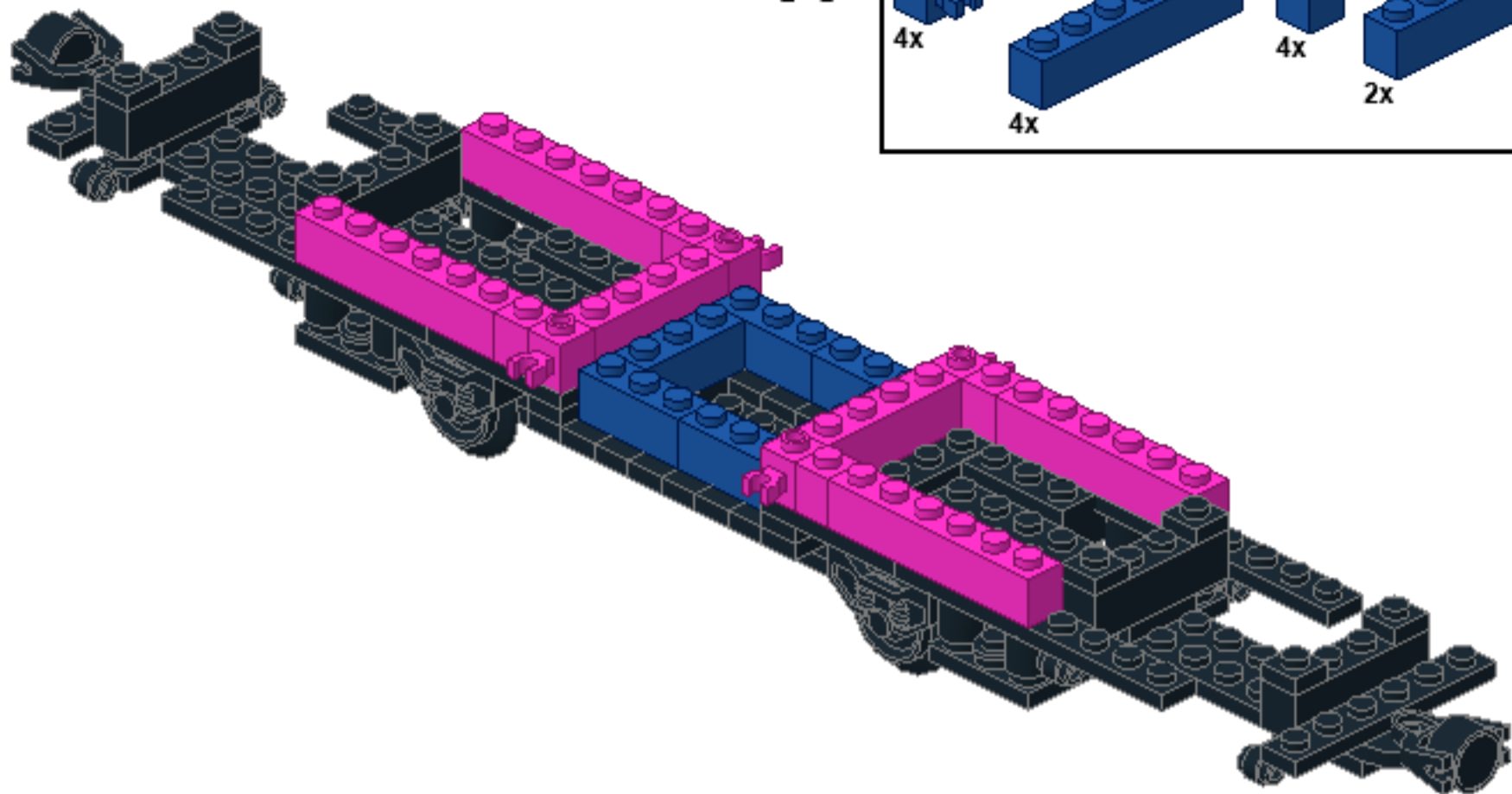
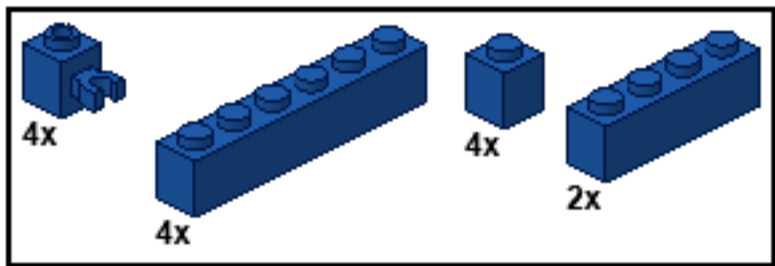

18

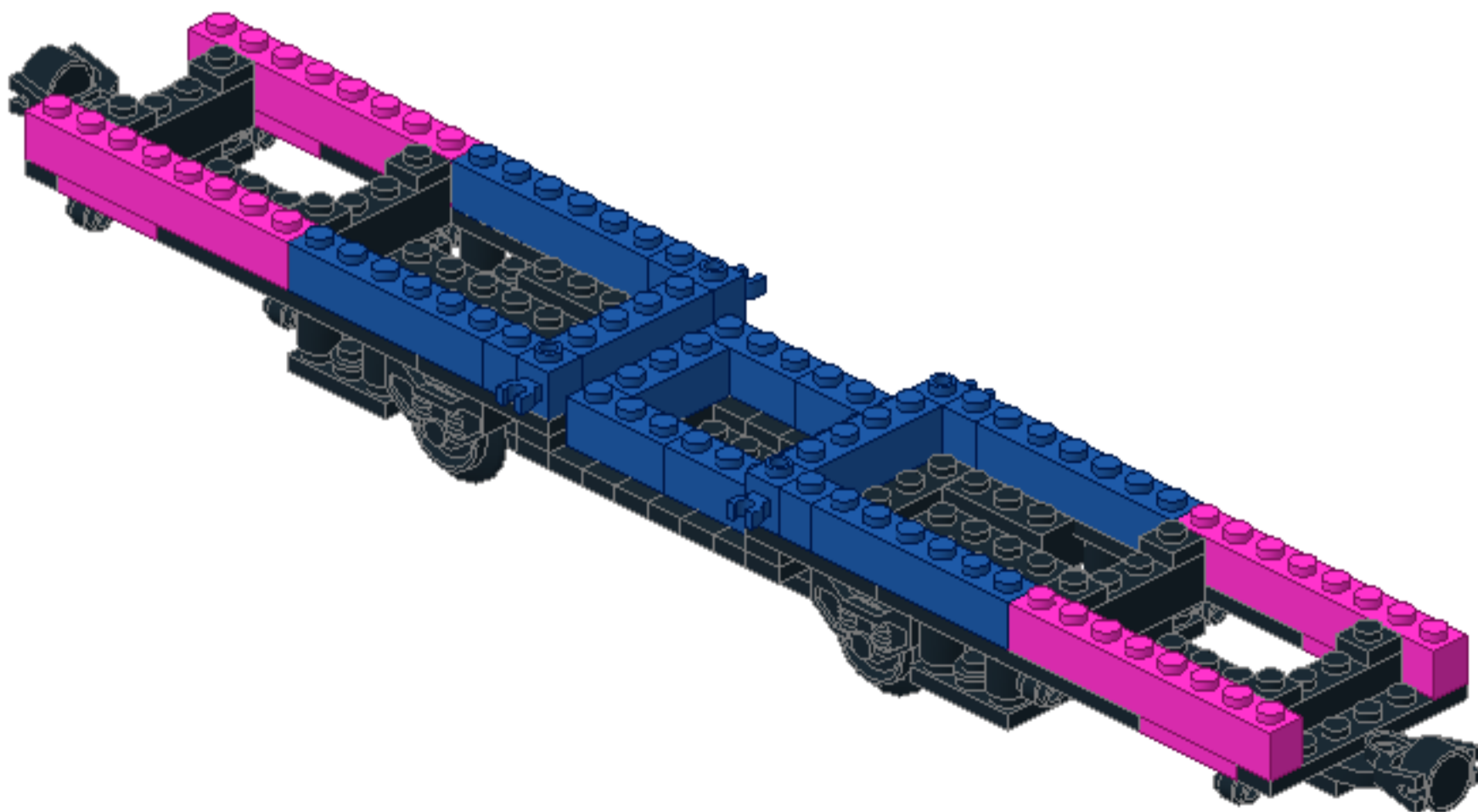
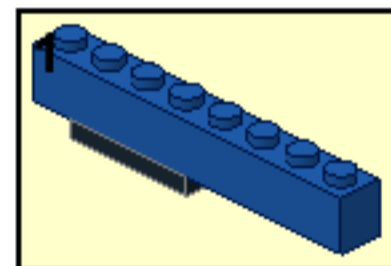
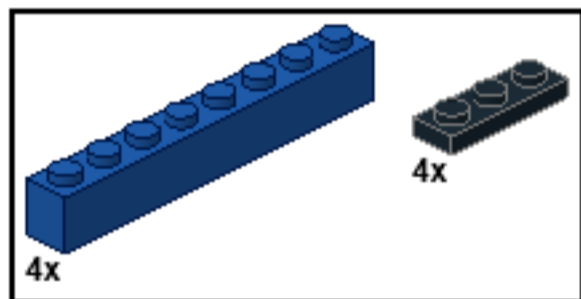

19

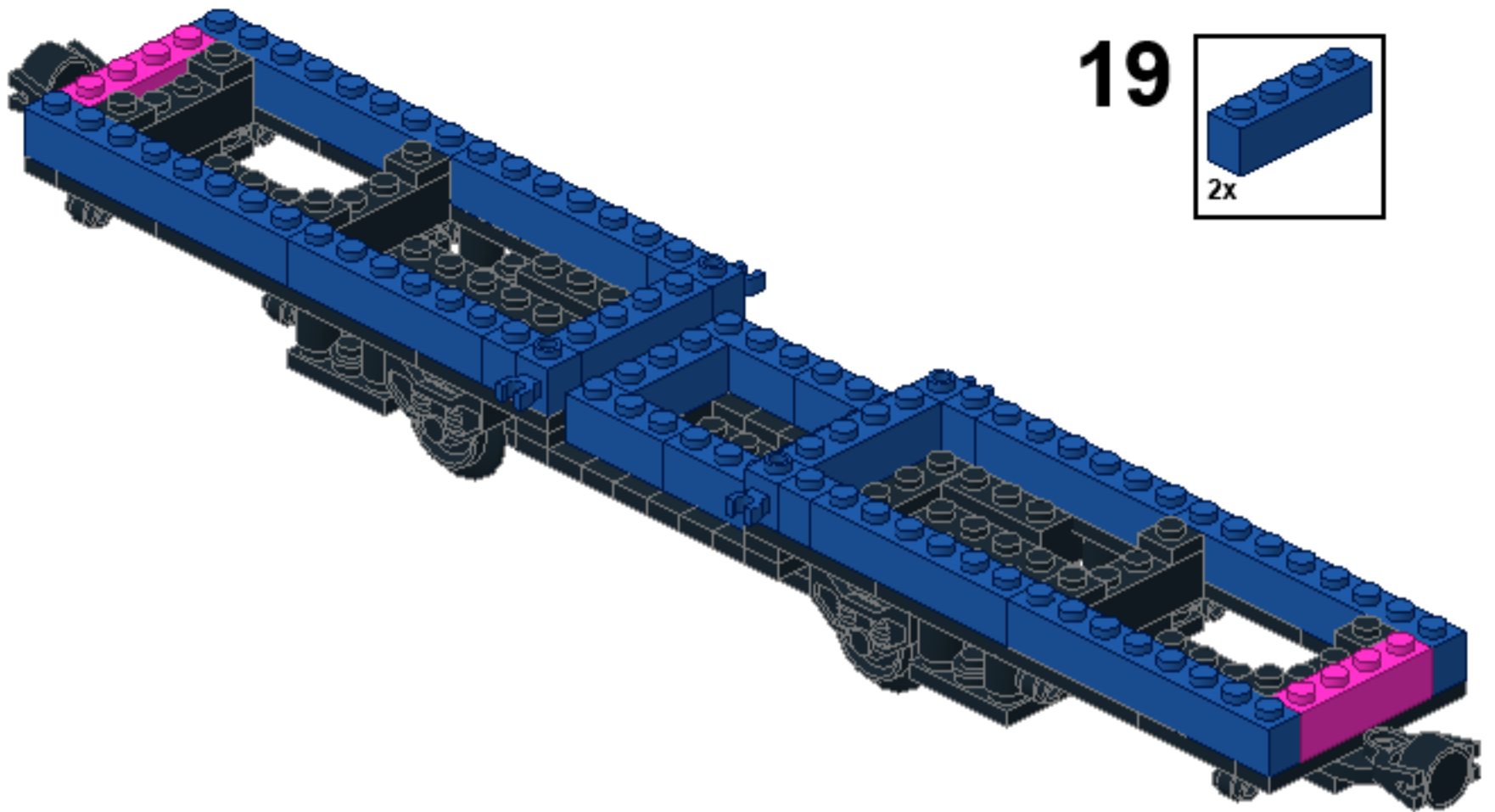
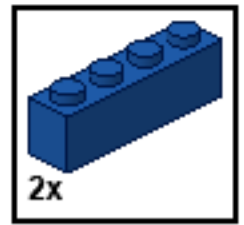

20

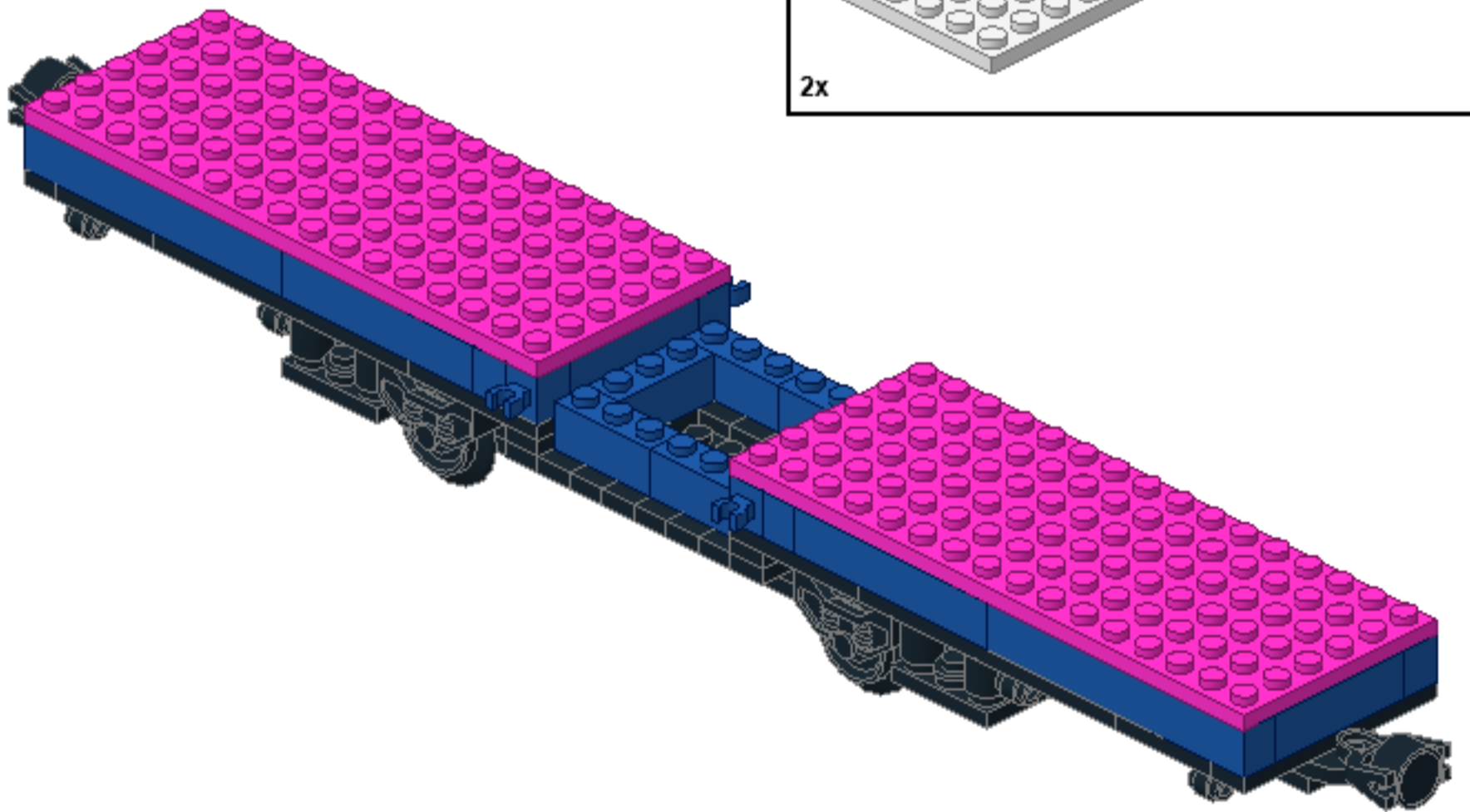
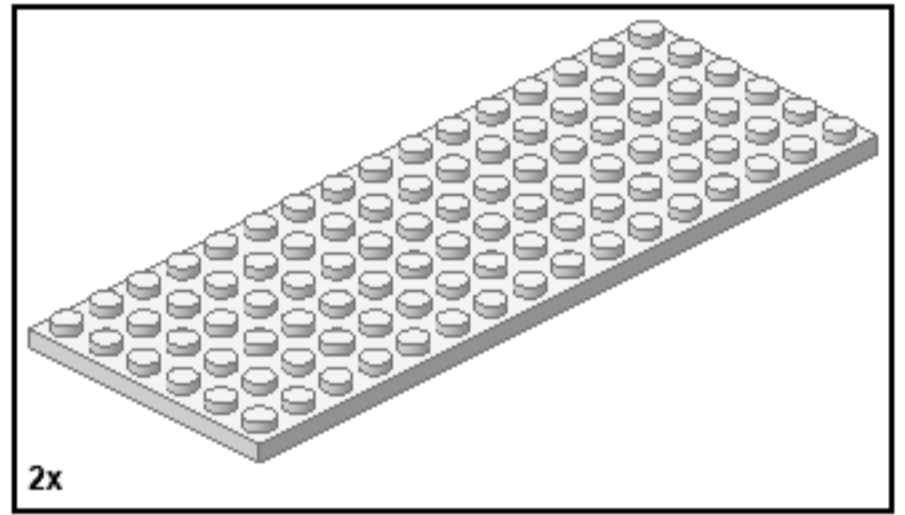

21

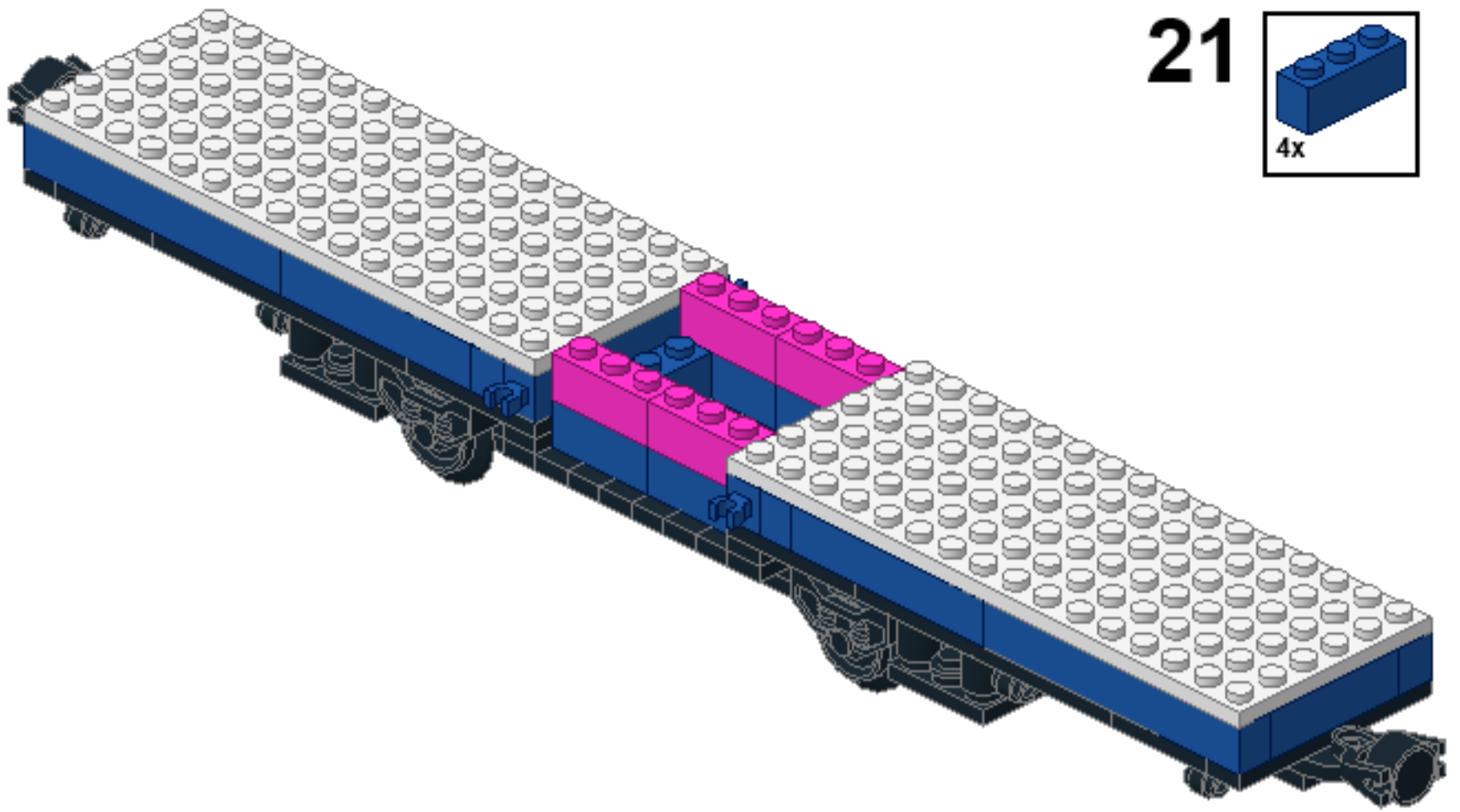
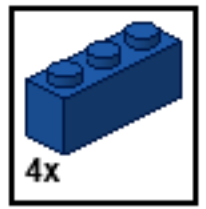

22

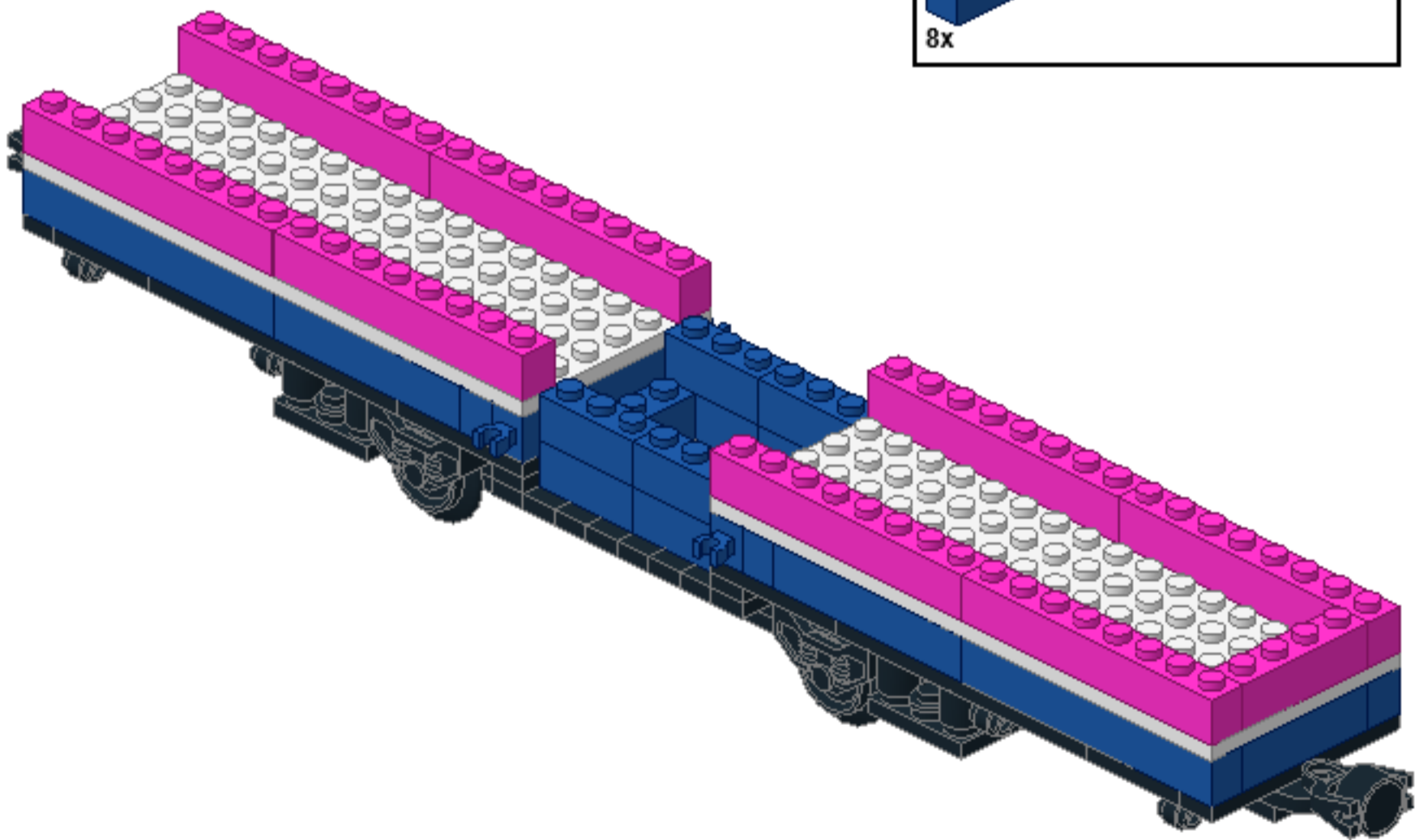
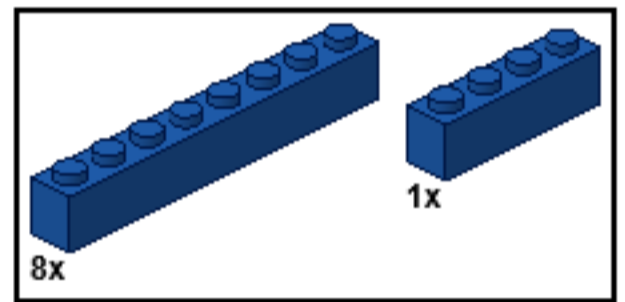

23

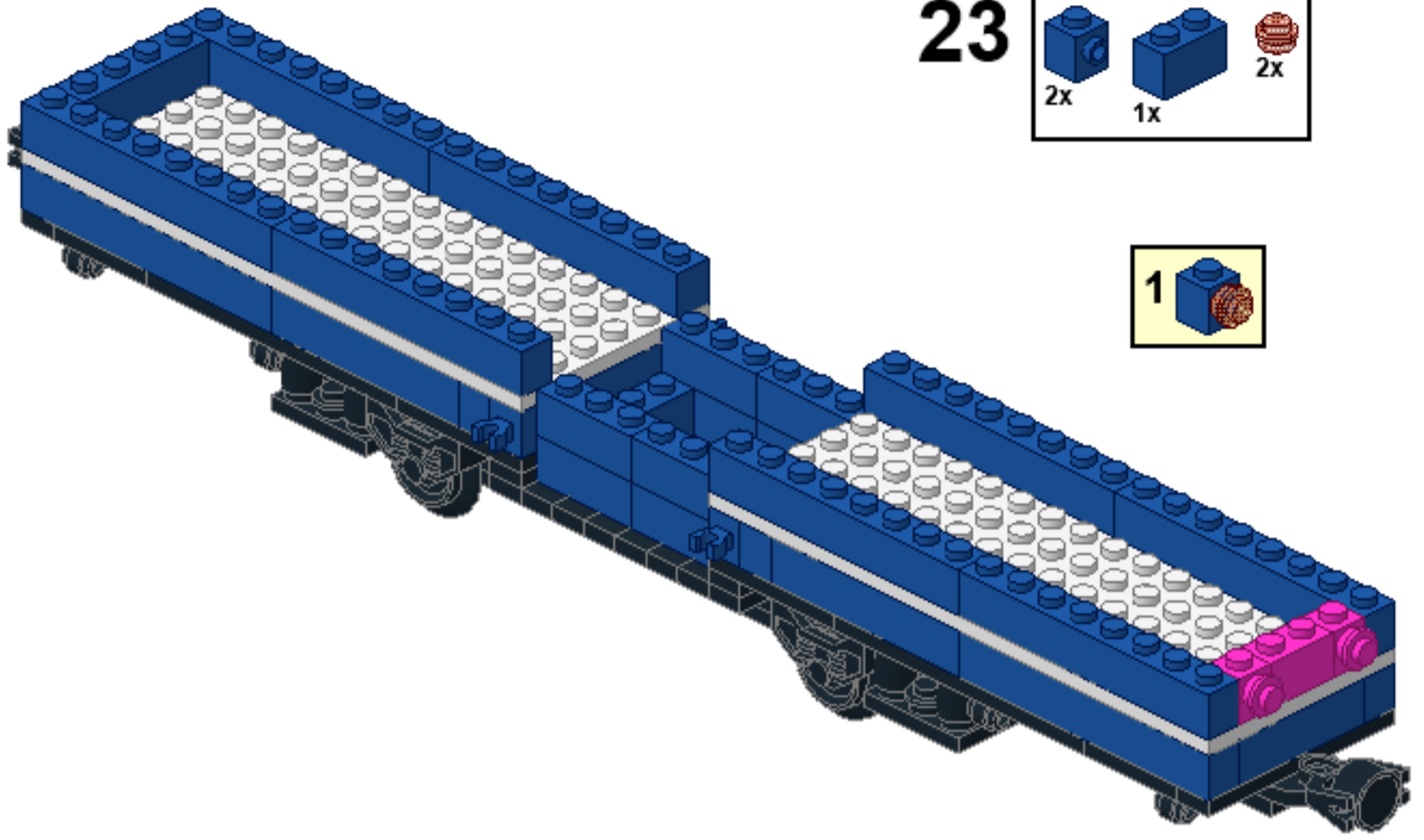
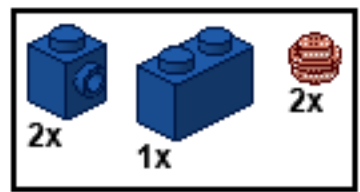

24

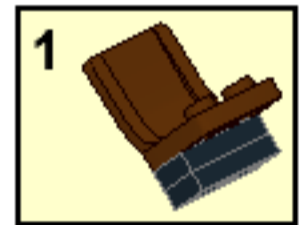
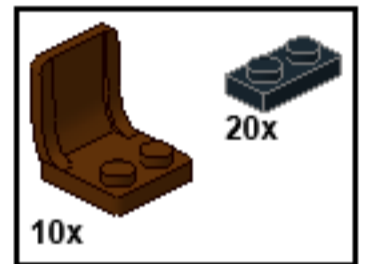

x10

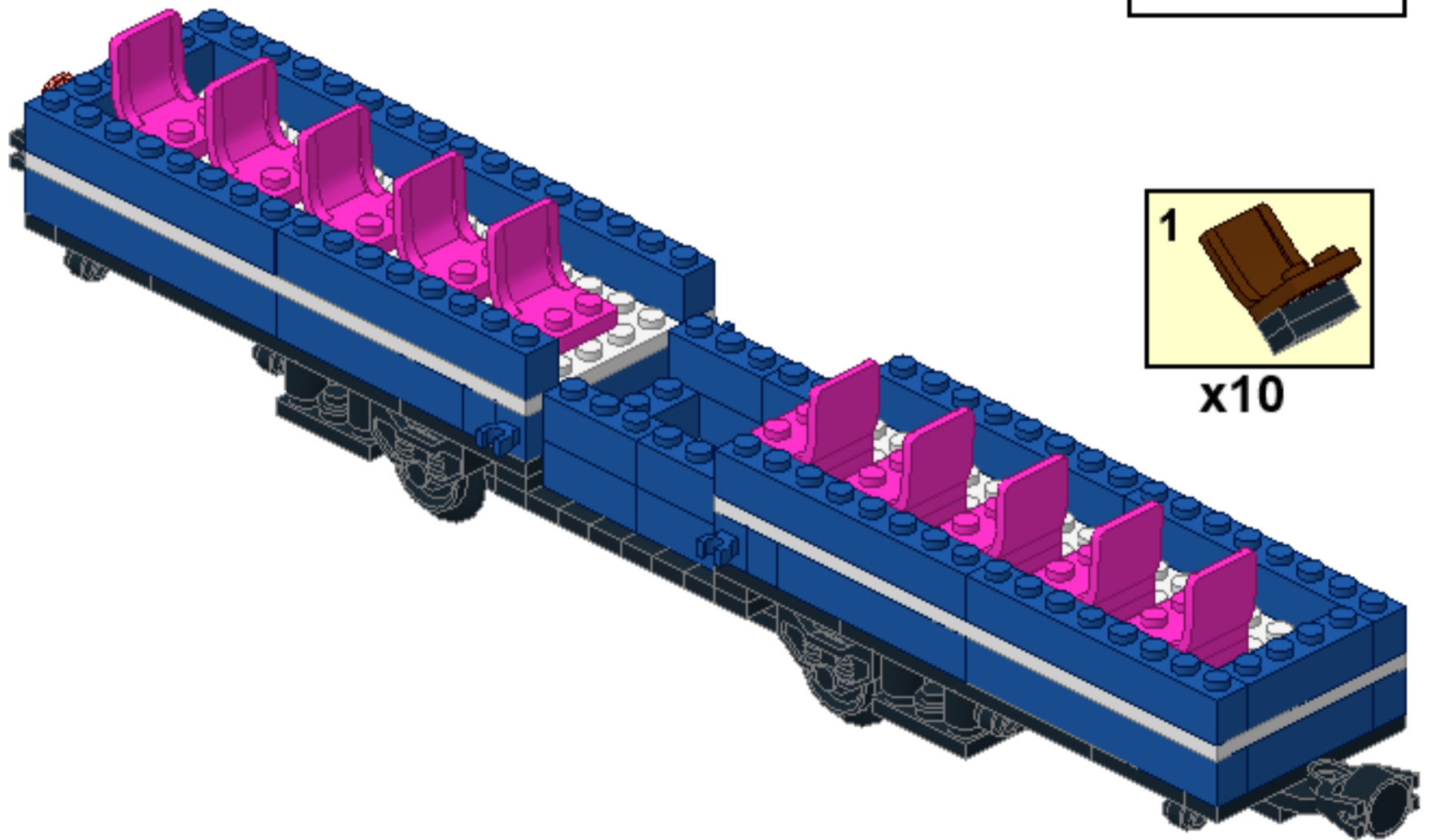

25

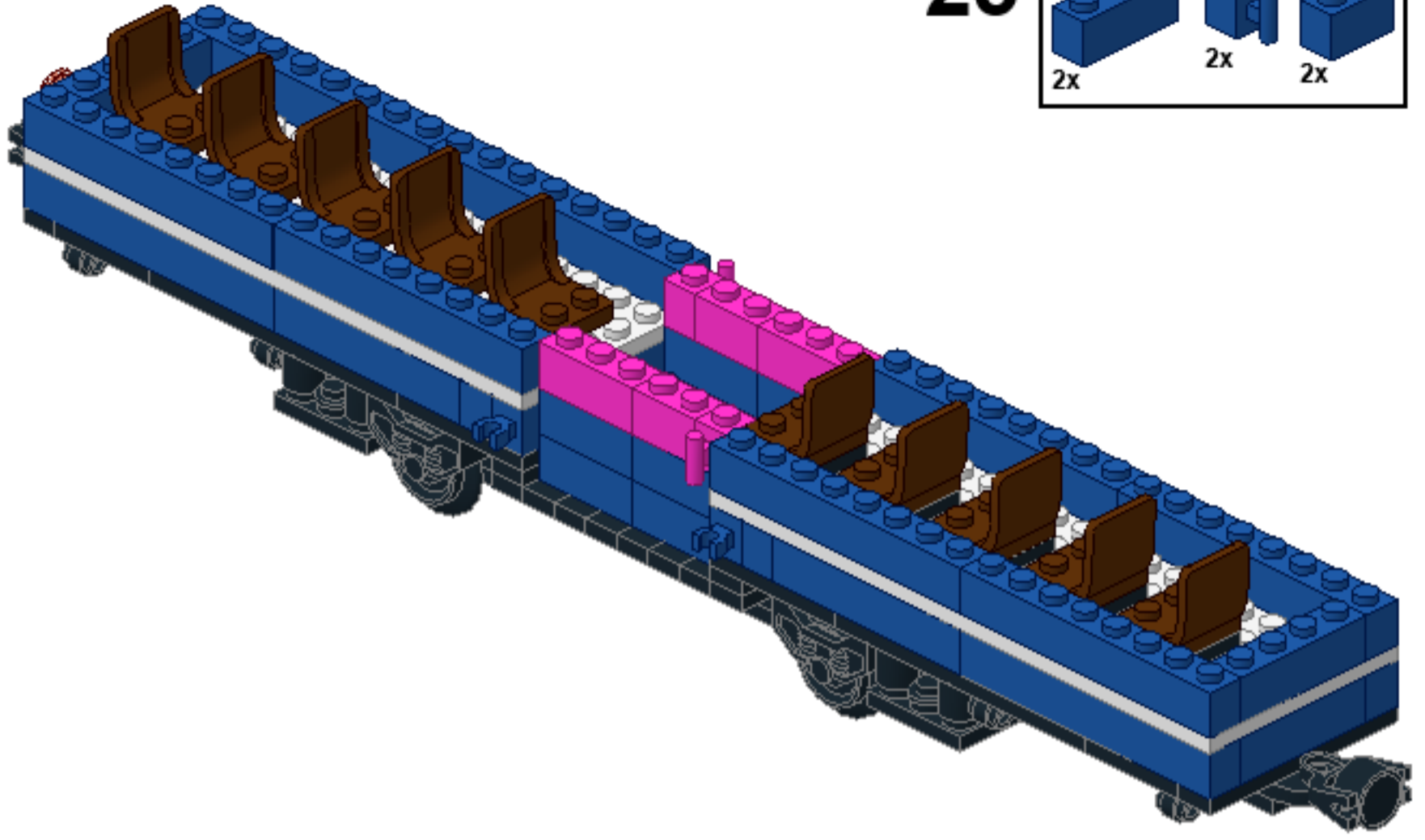
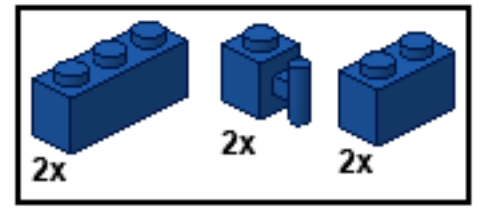

26

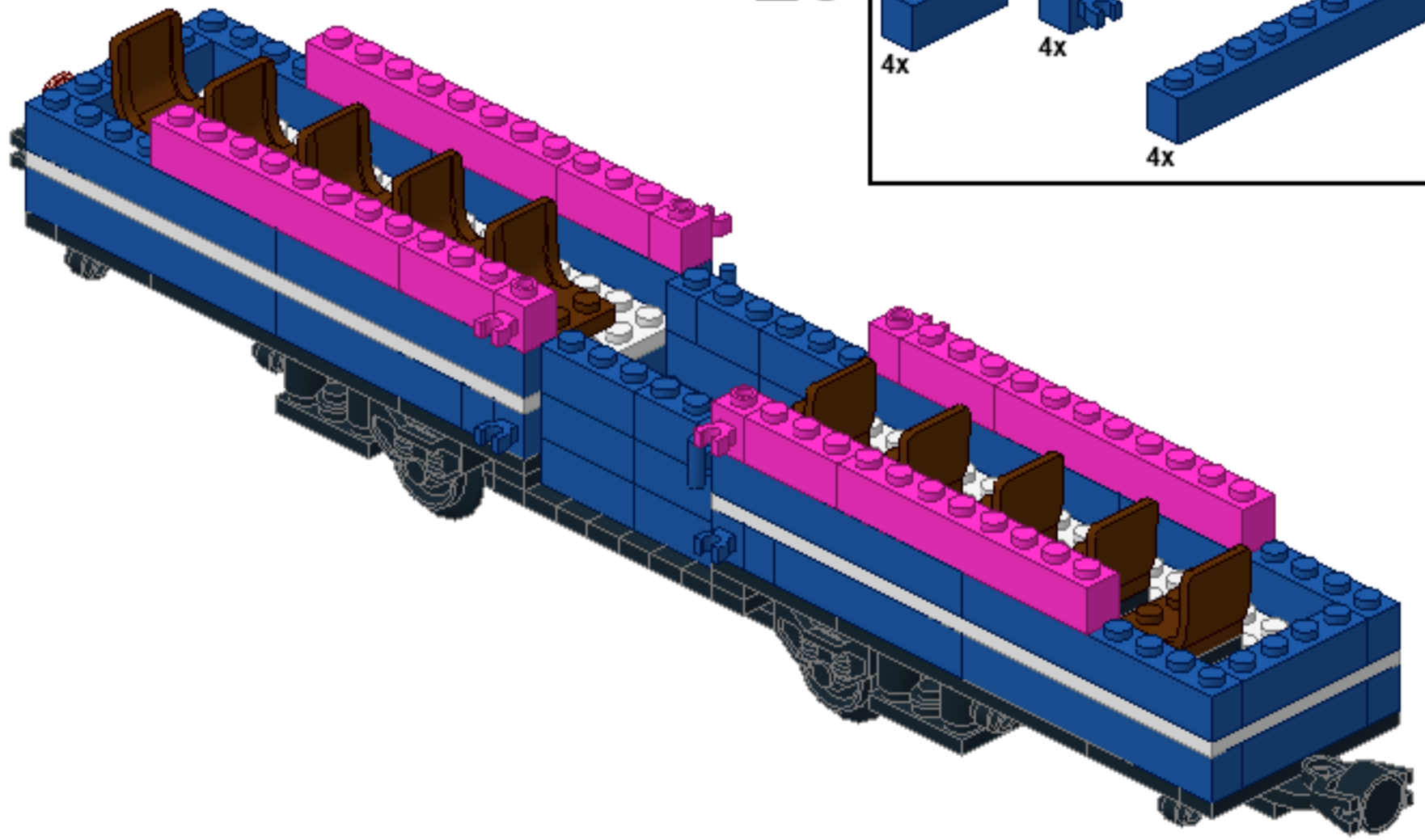
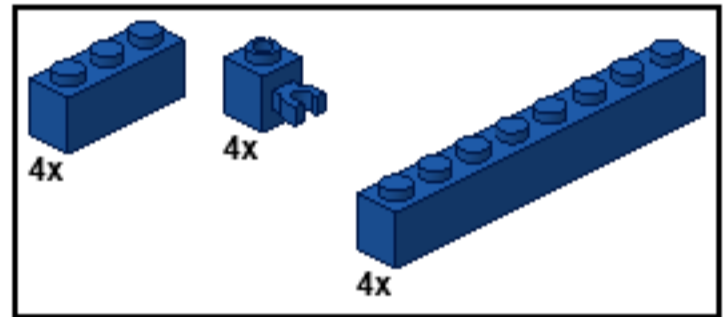

27

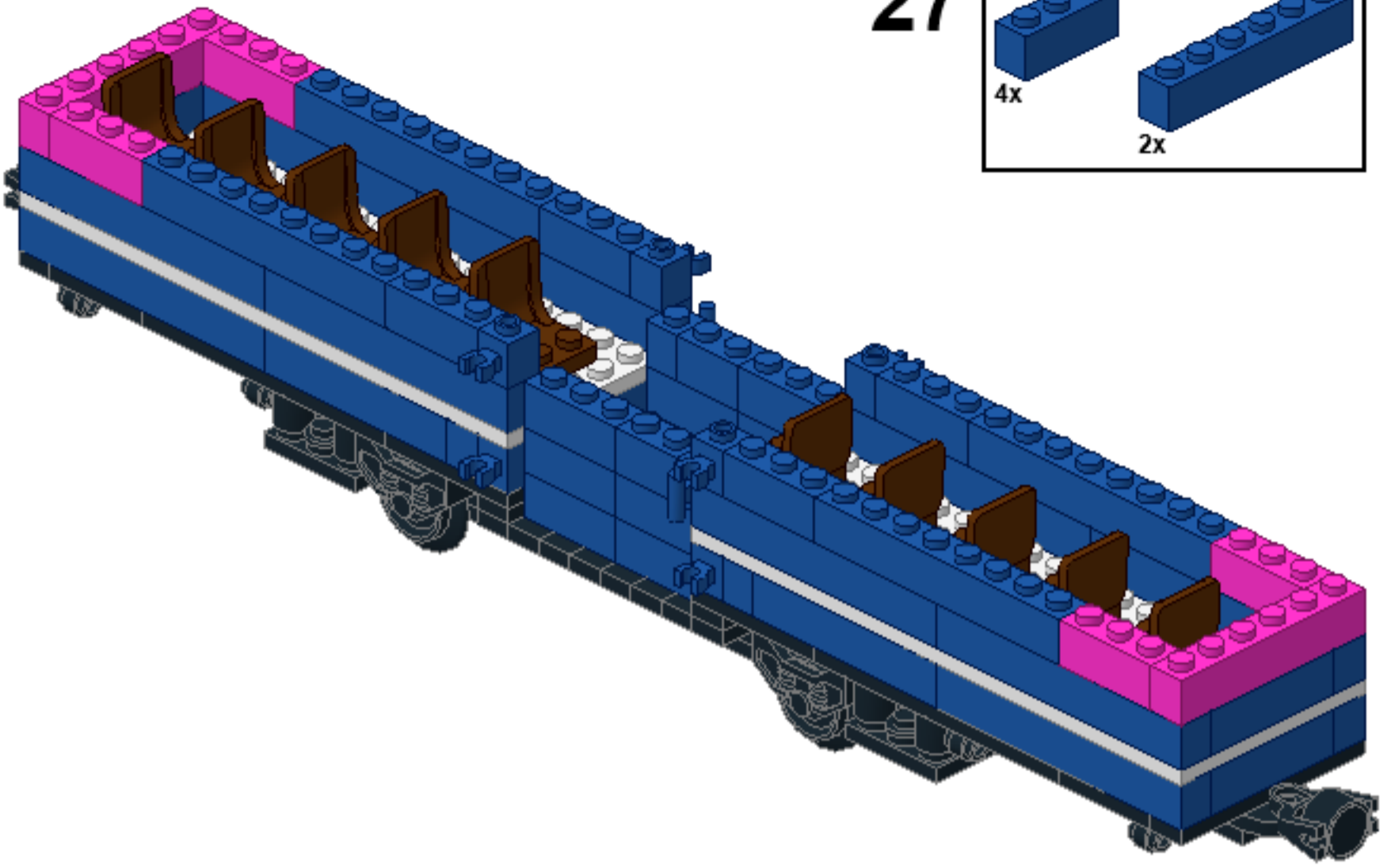
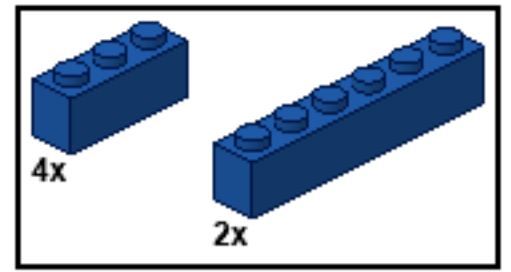

28

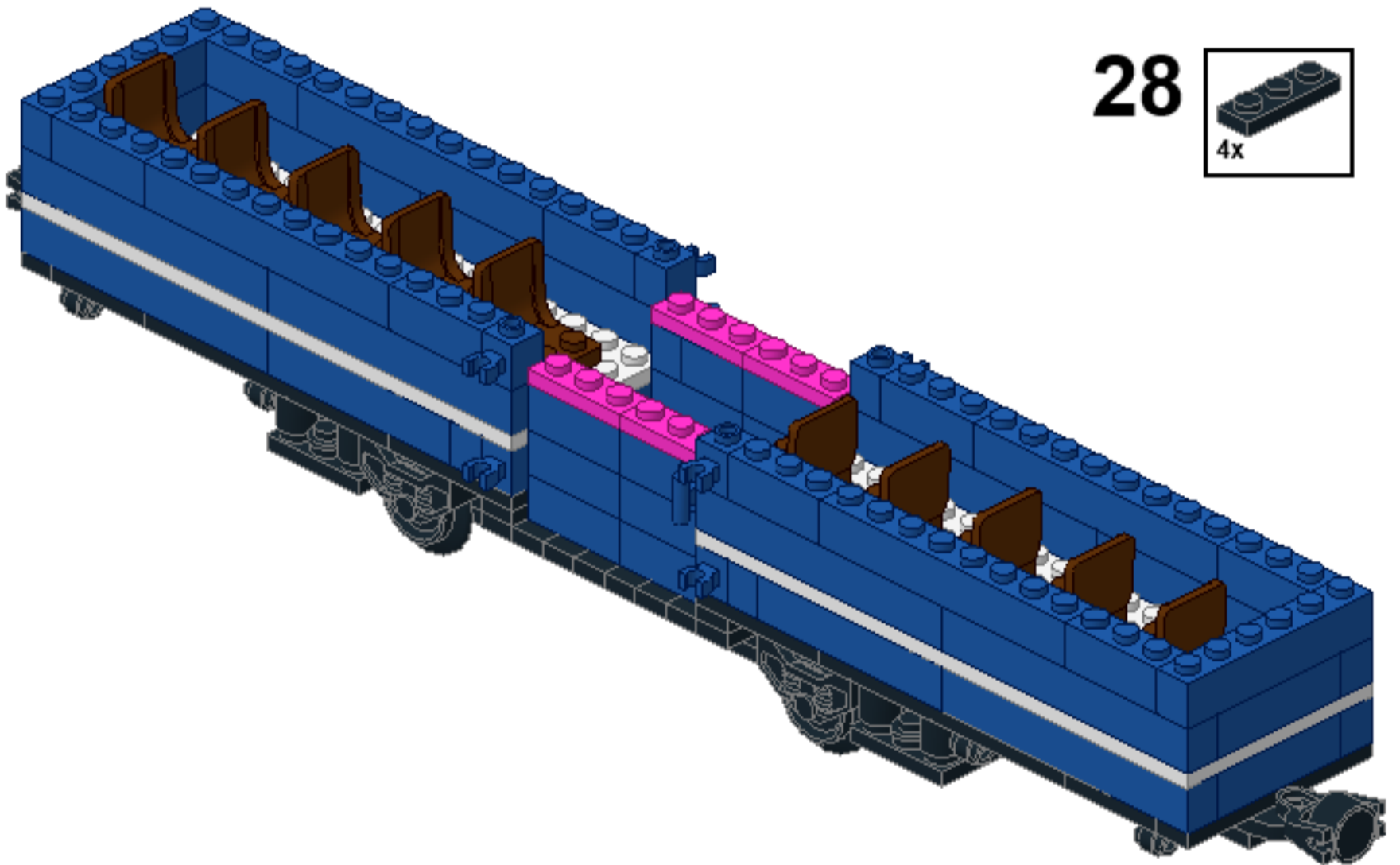
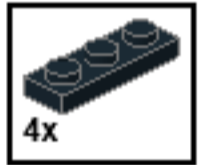

29

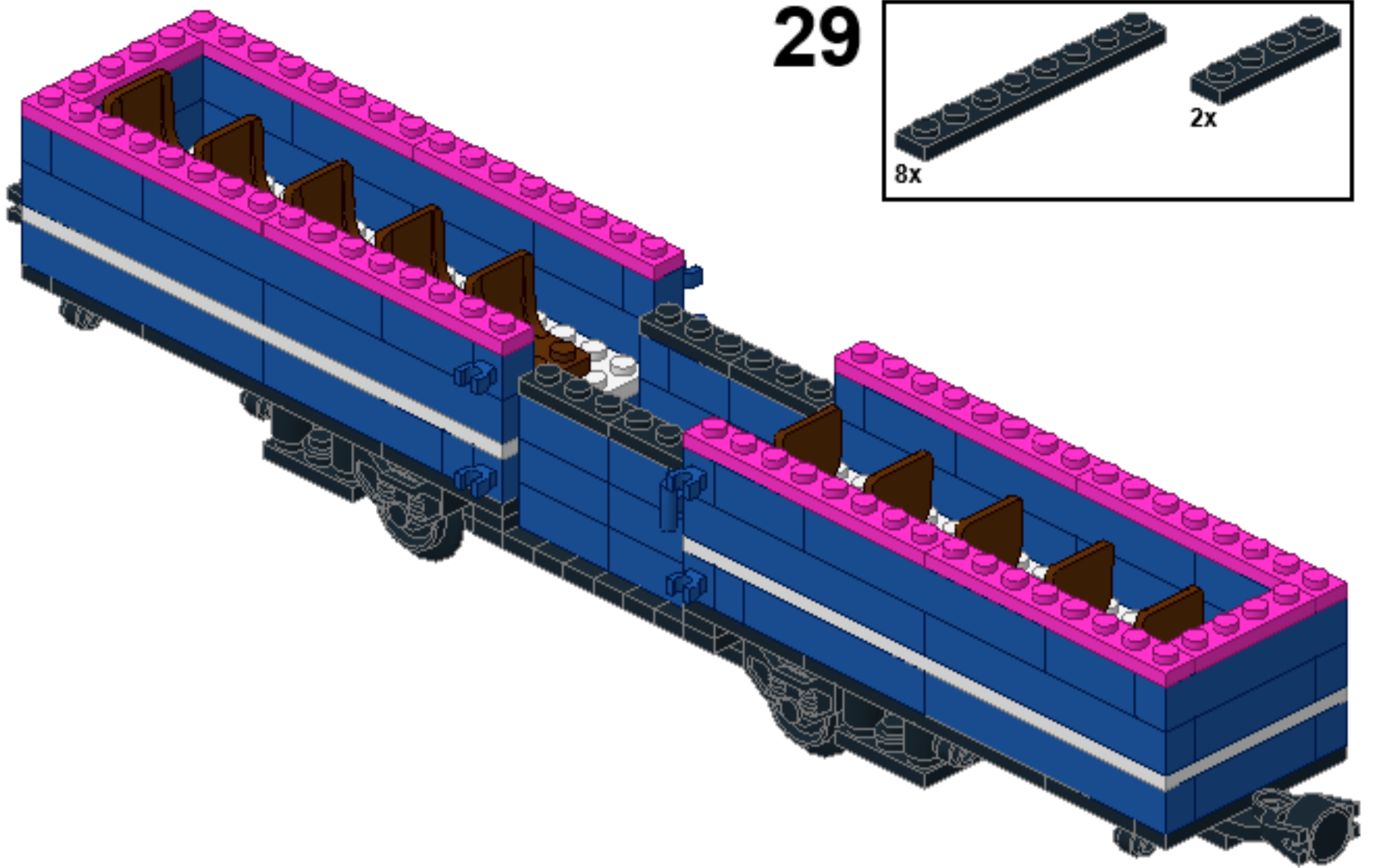
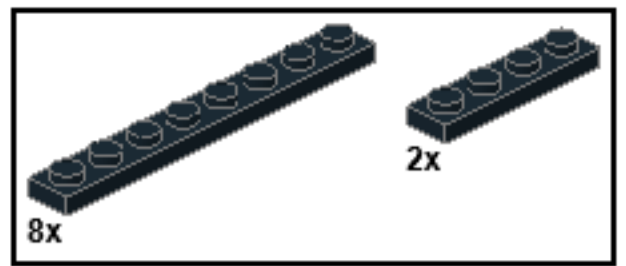

30

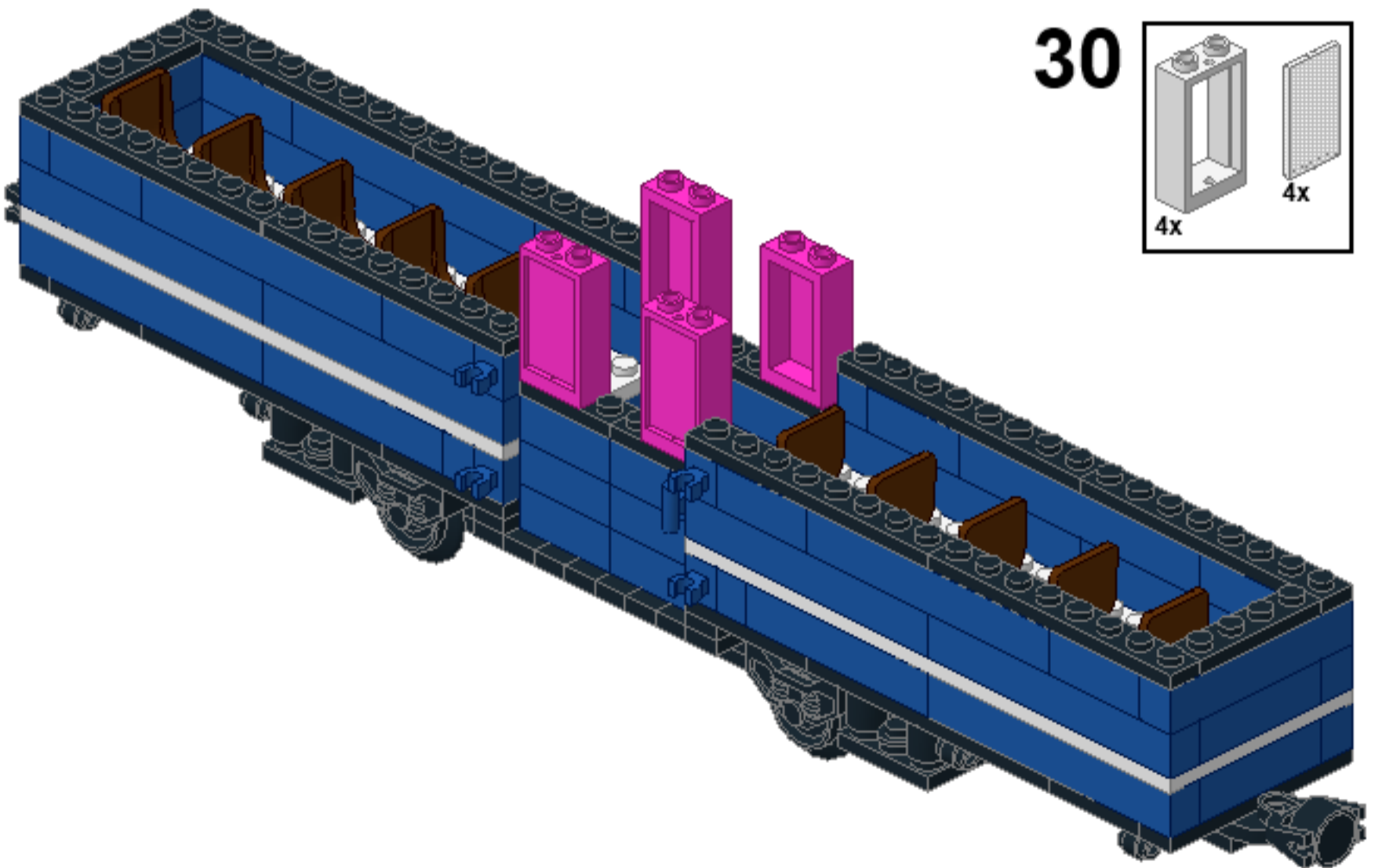
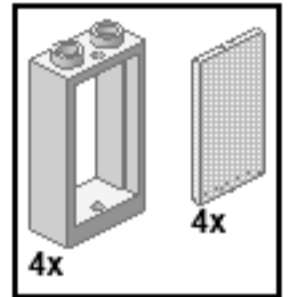

31

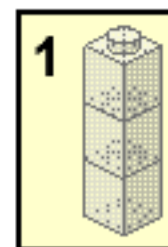

x4

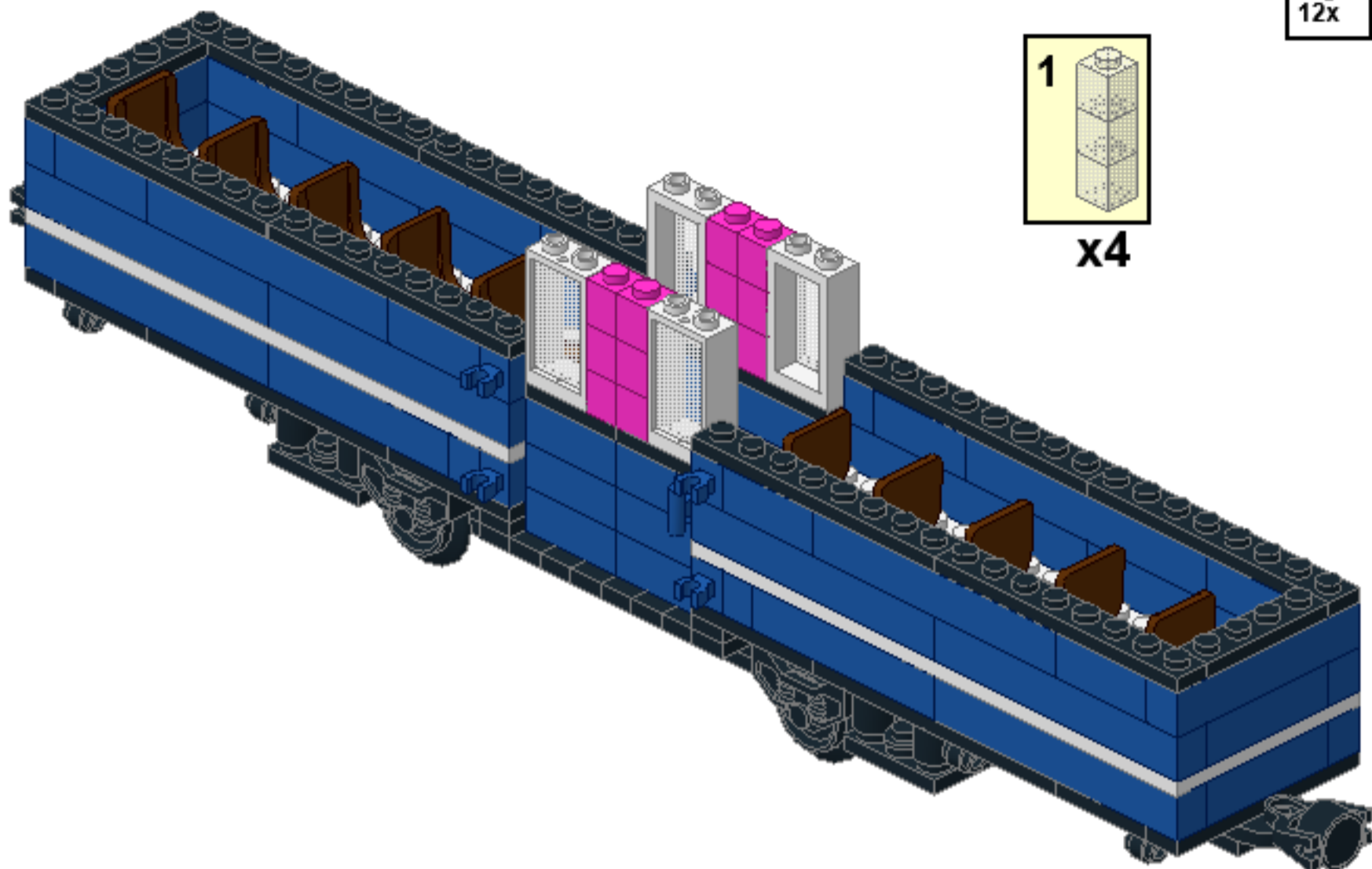

32

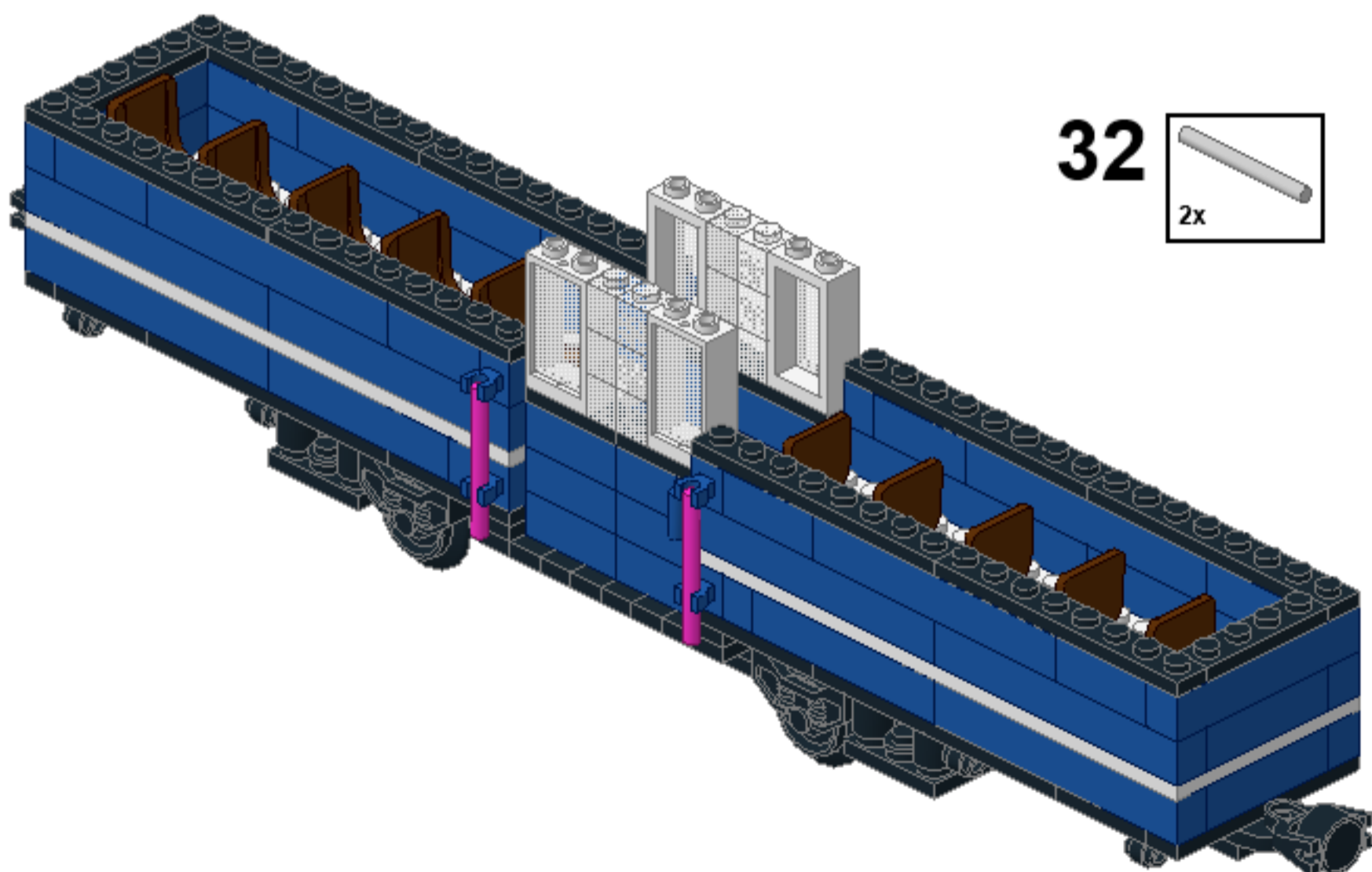
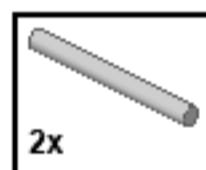

33

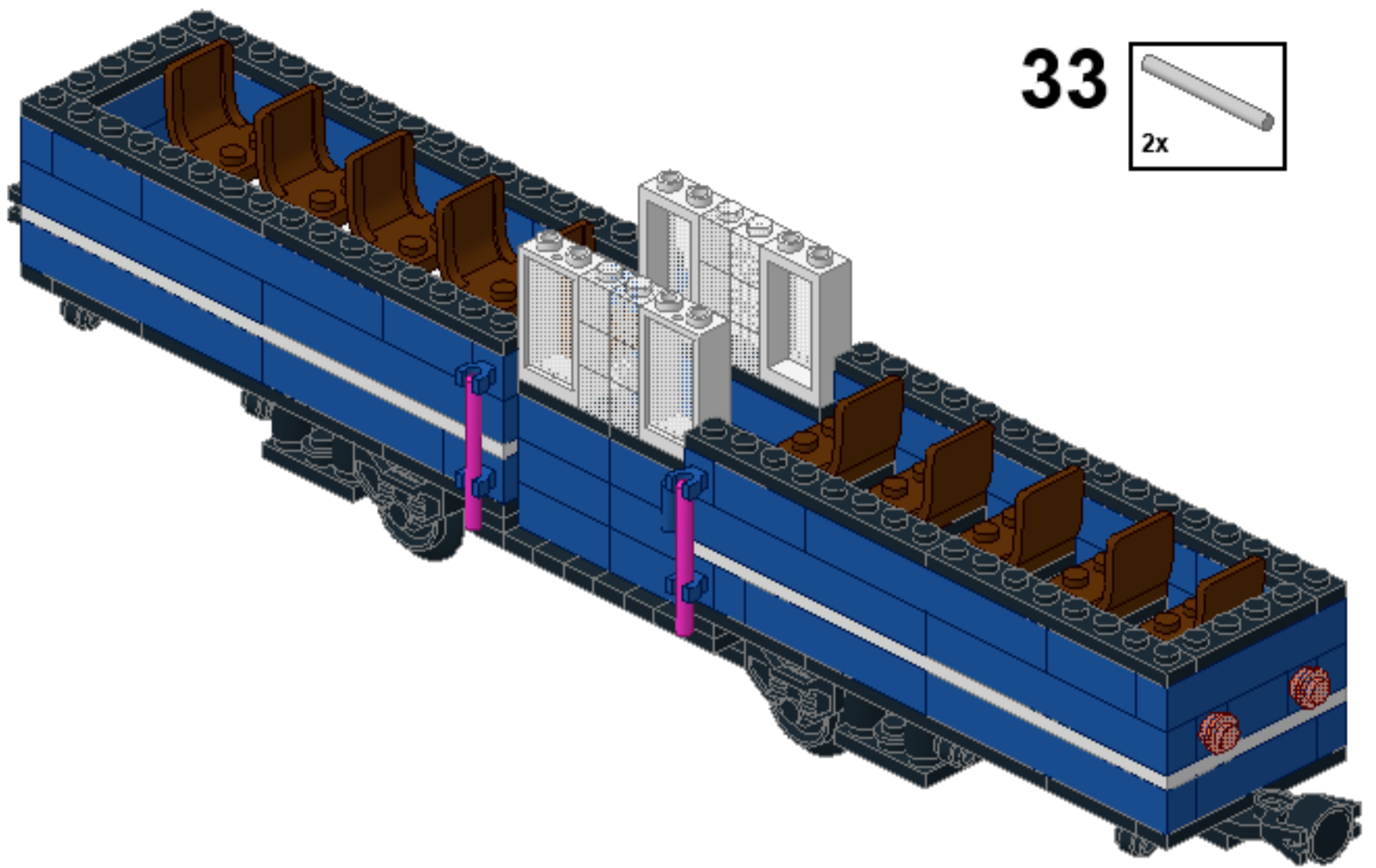
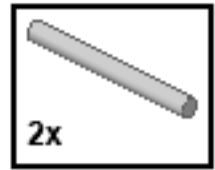

34

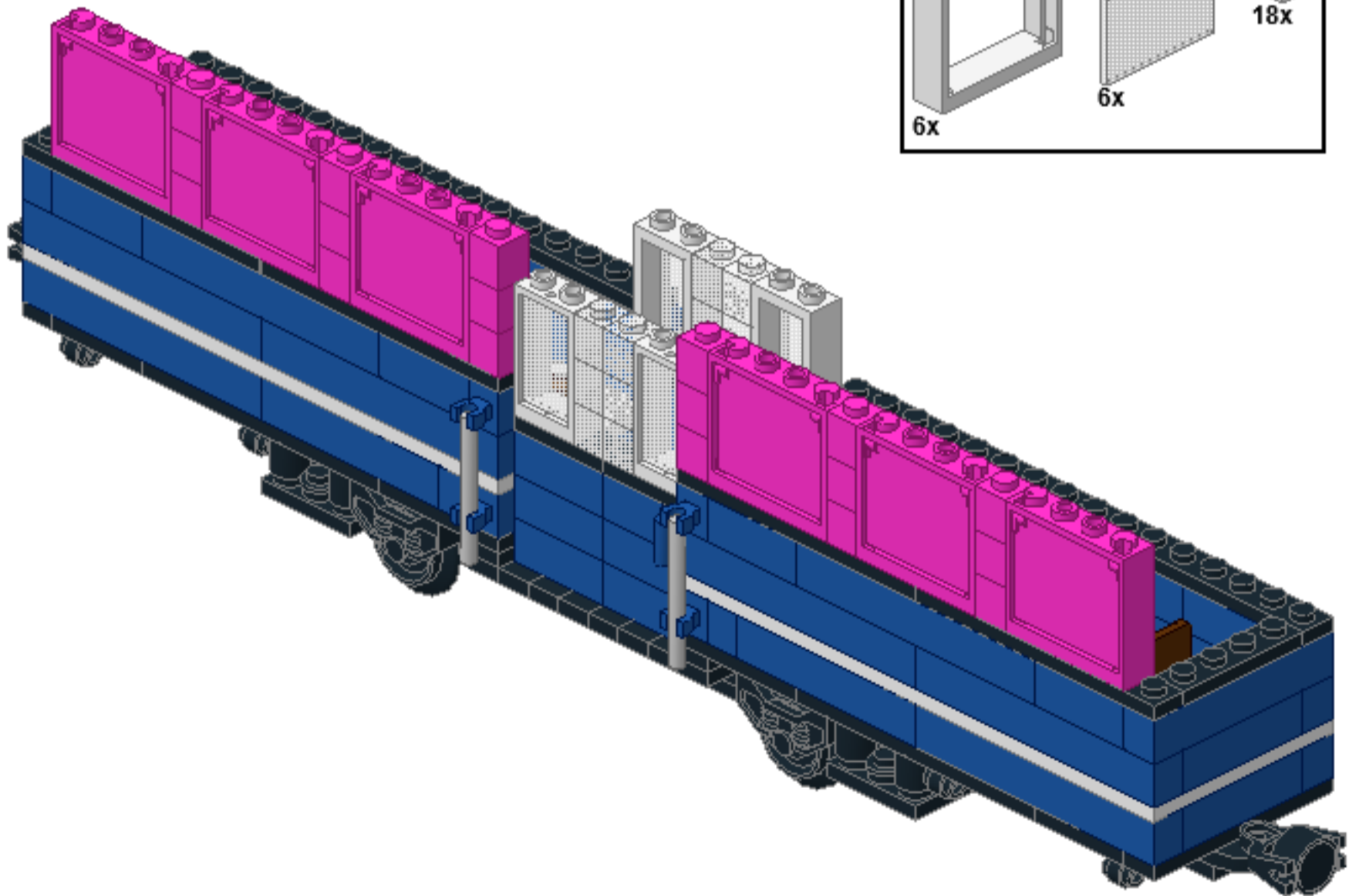
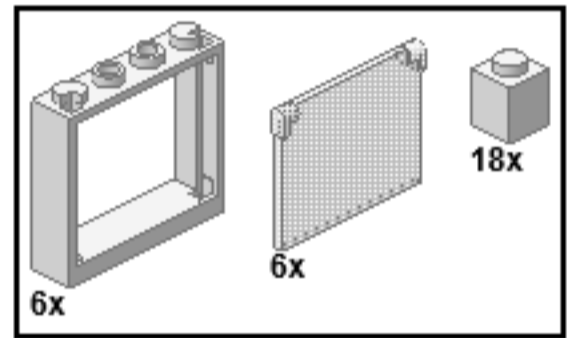

35

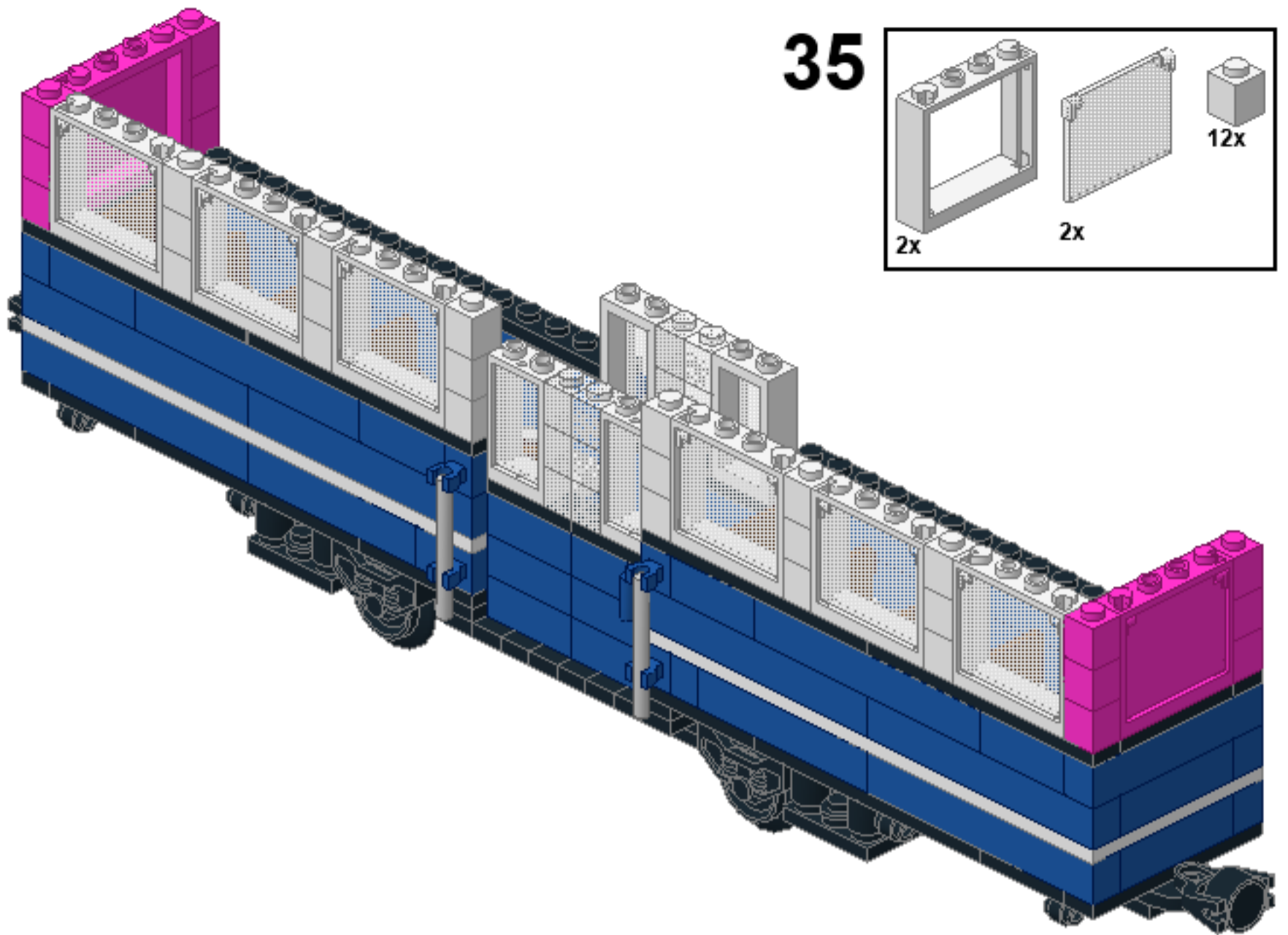
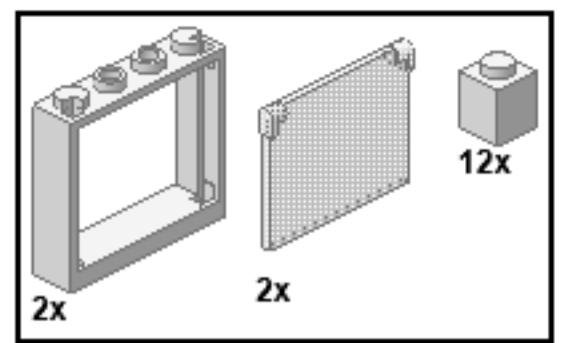

36

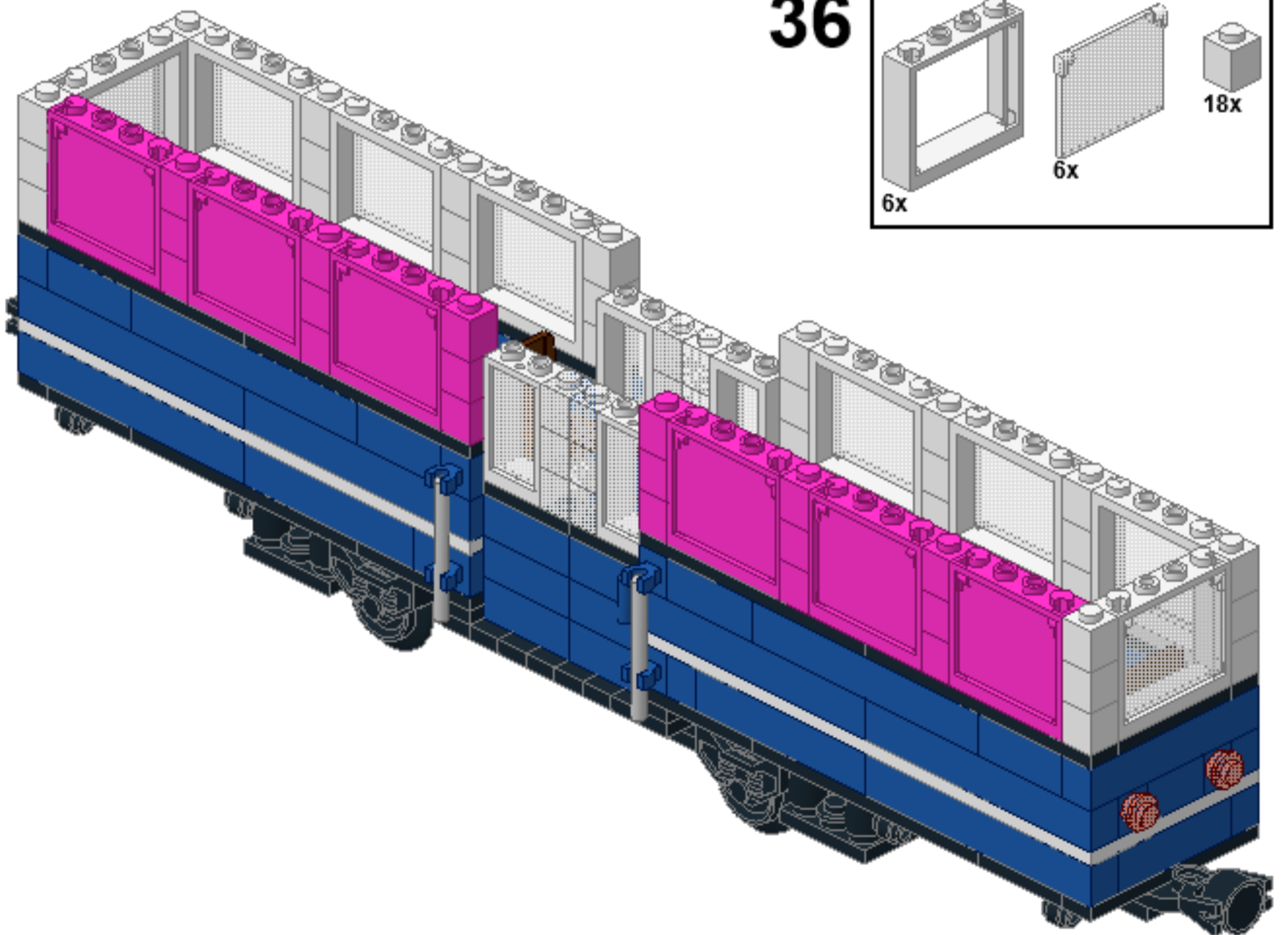
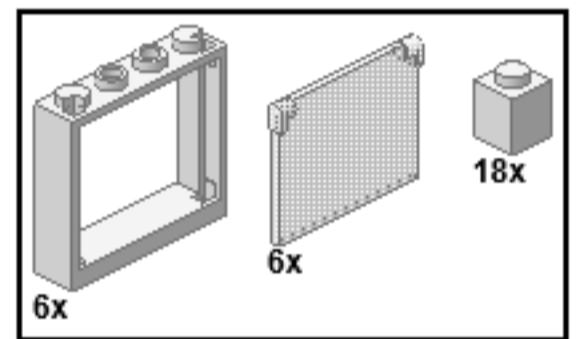

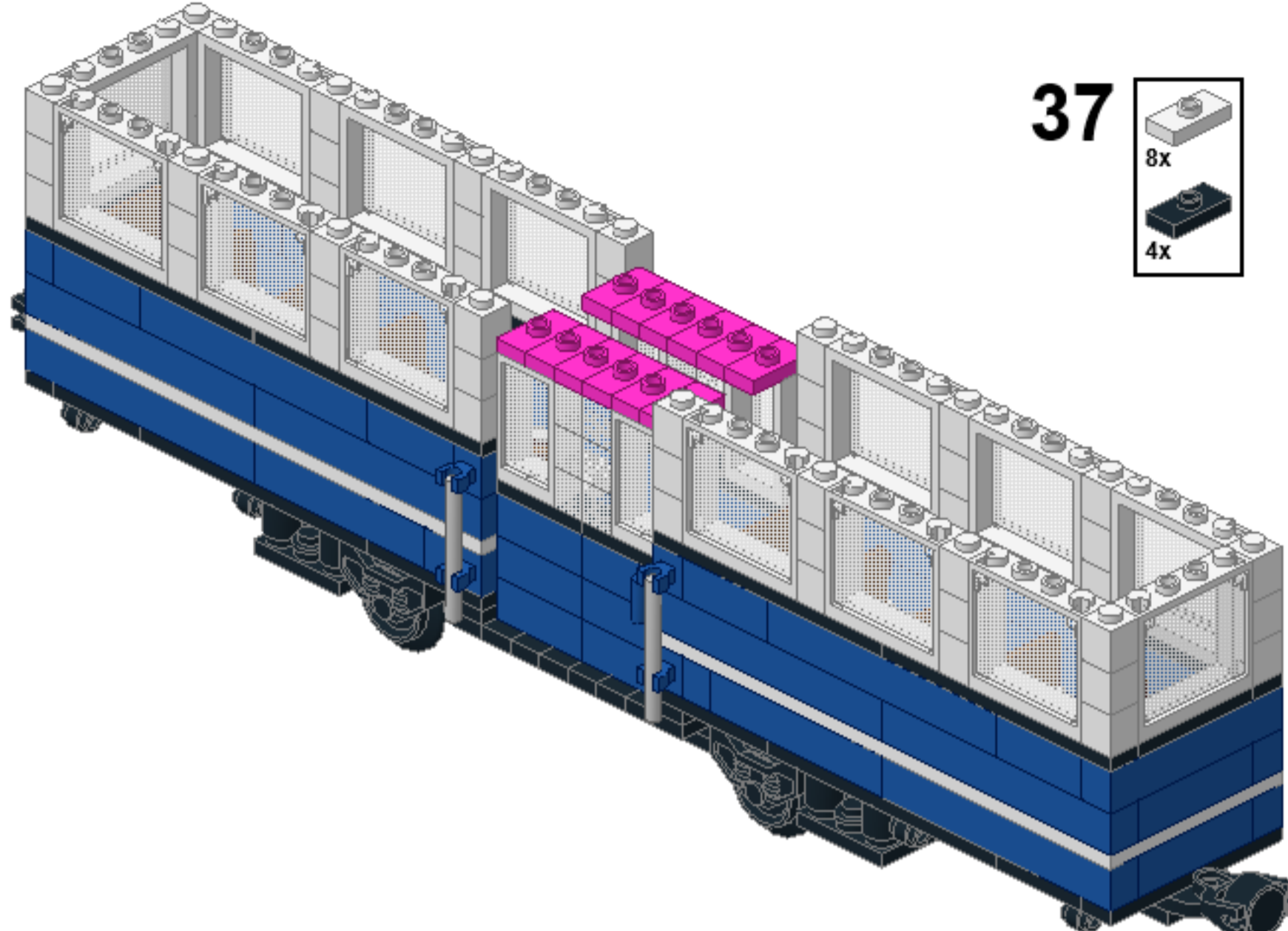

37

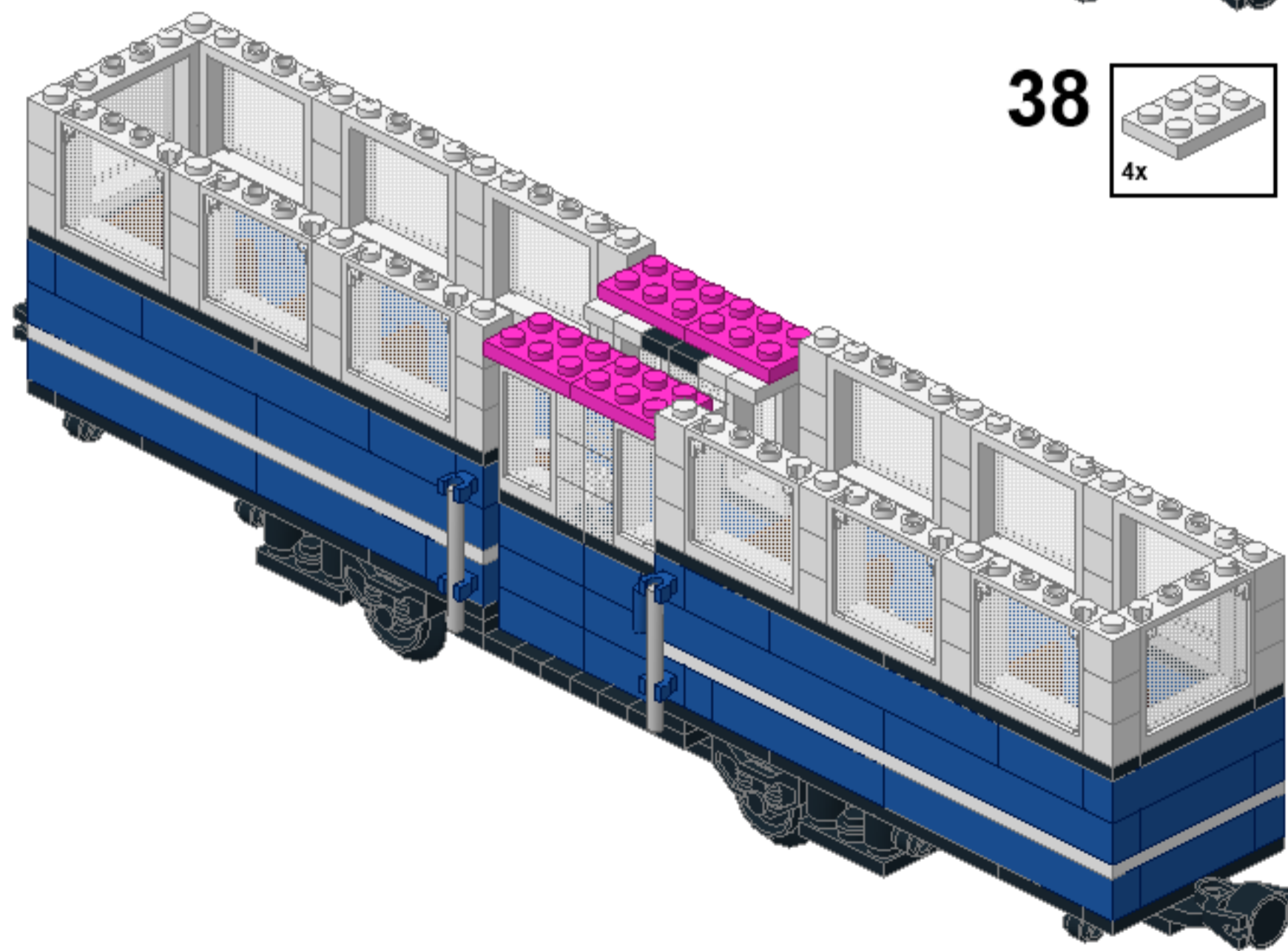
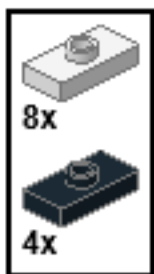

38

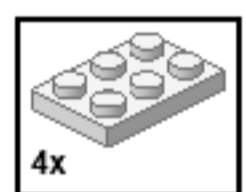

39

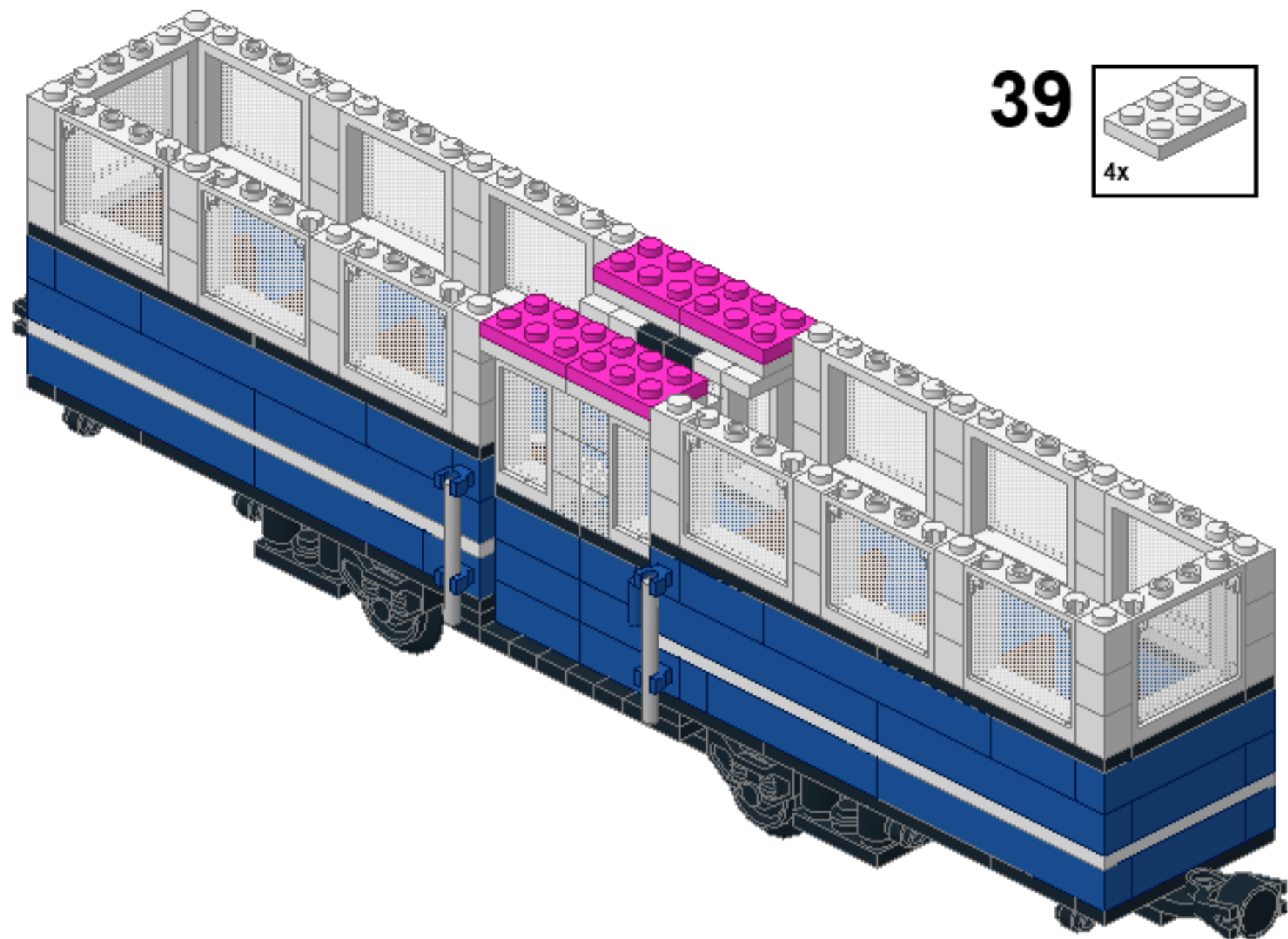
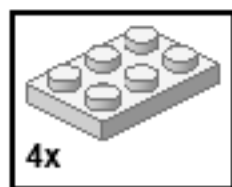

40

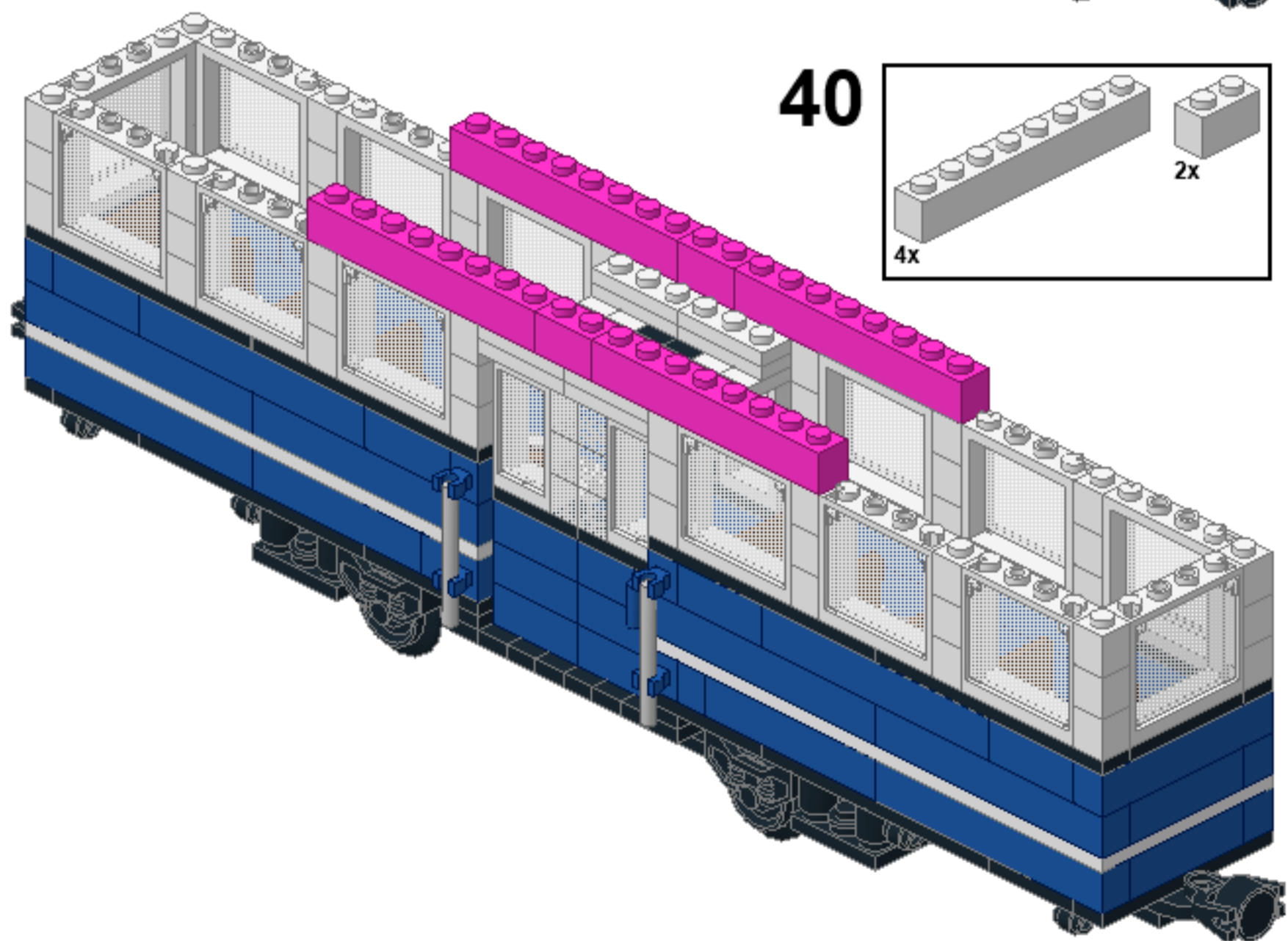
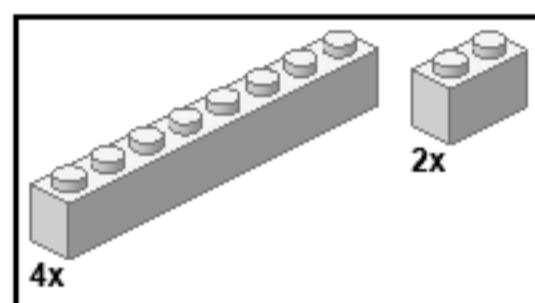

41

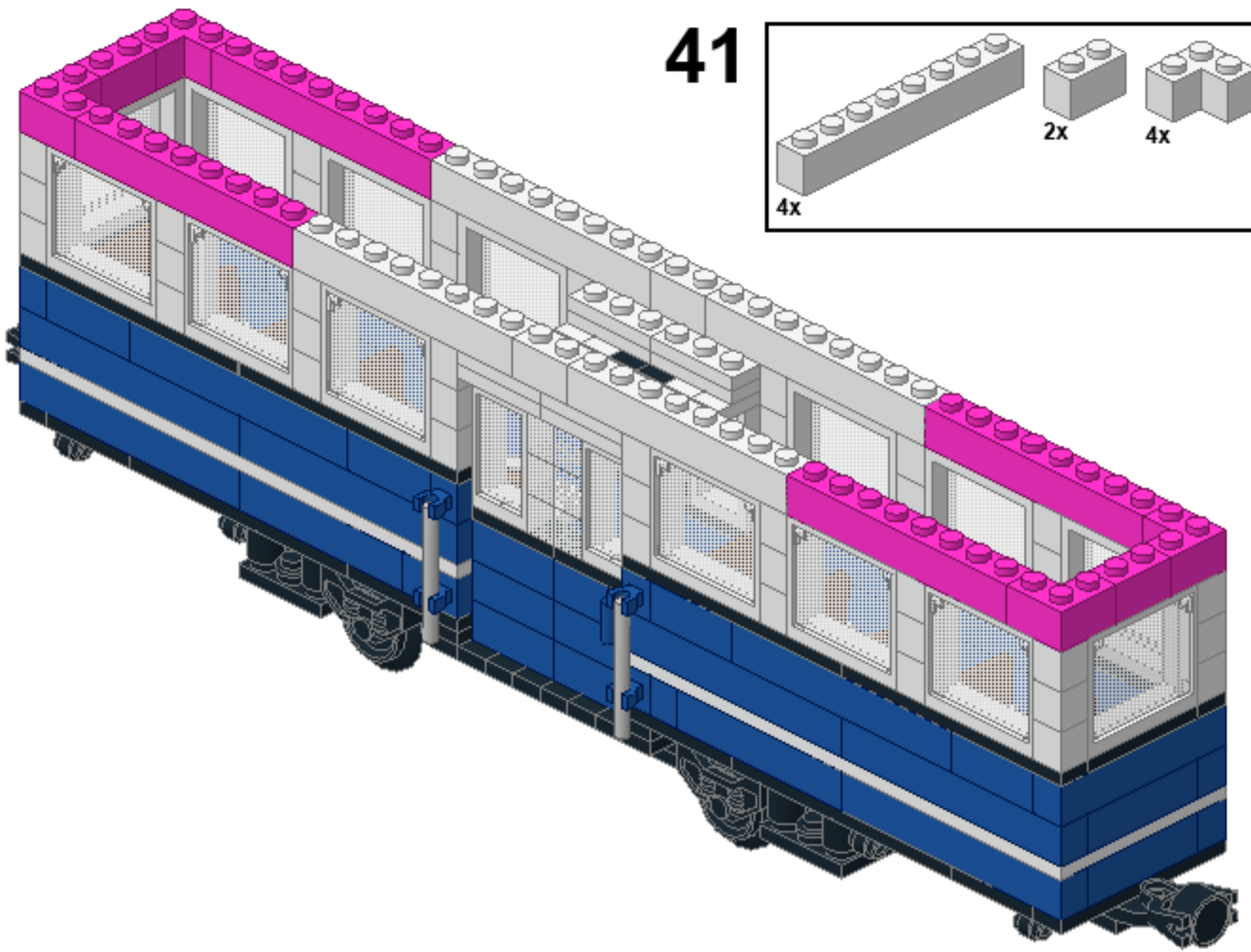
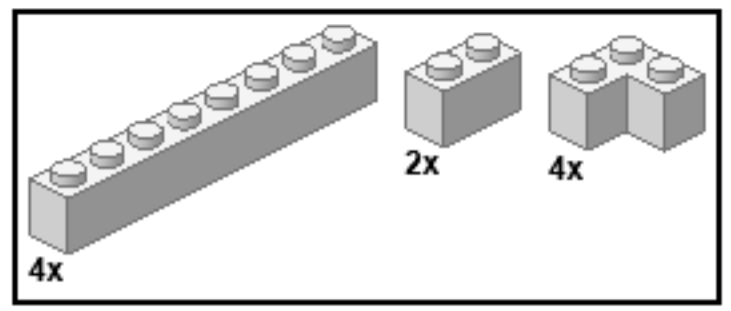

42

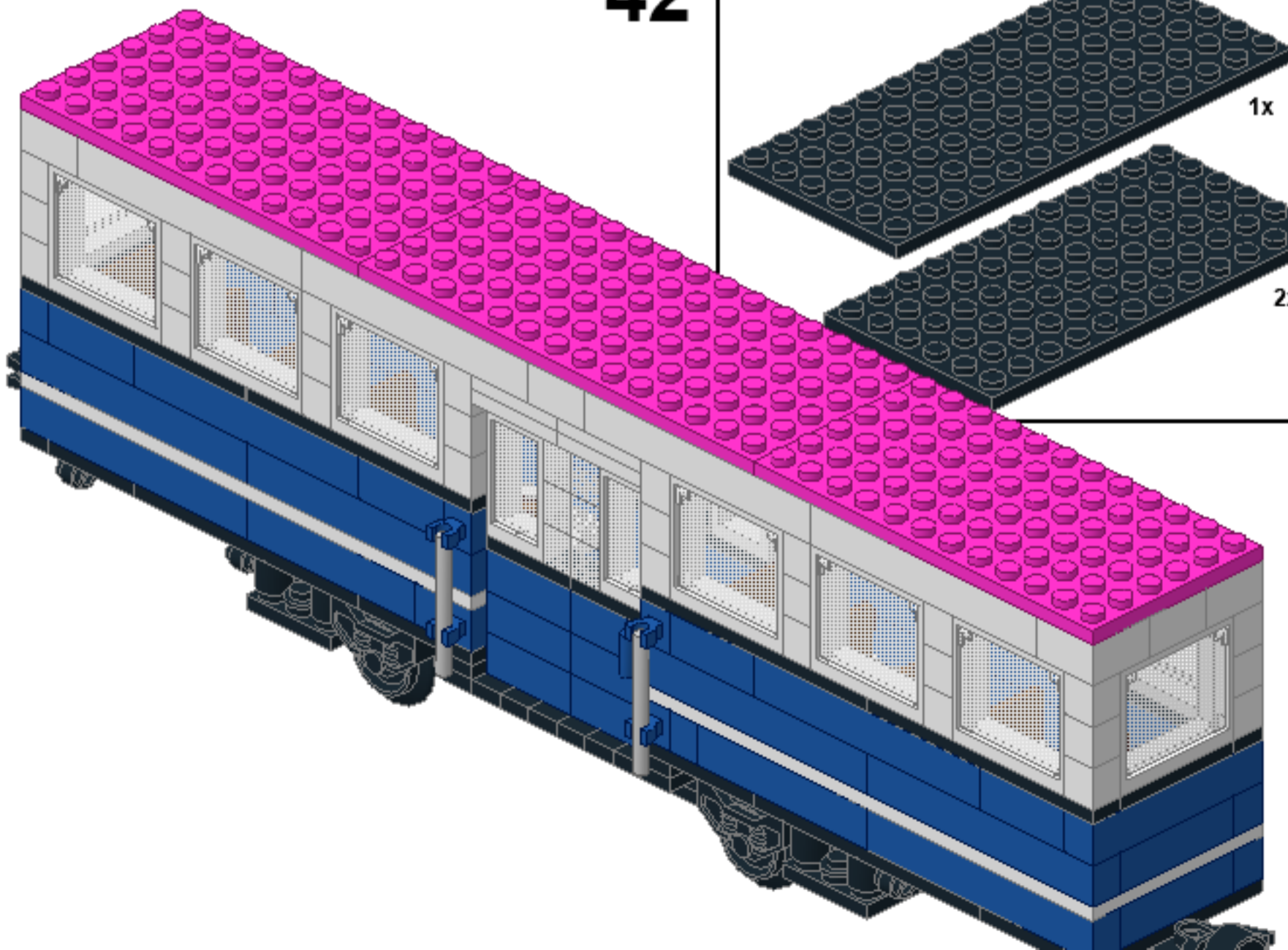
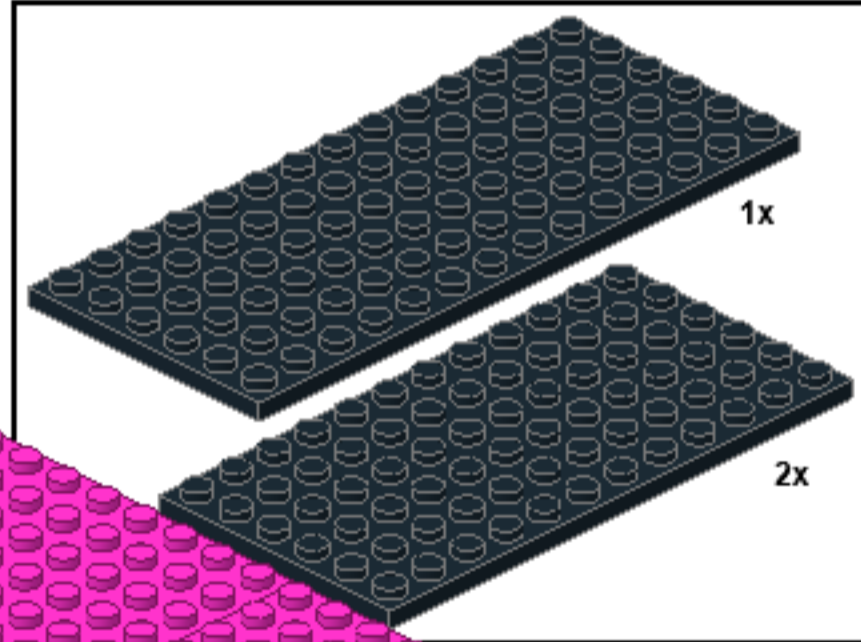

43

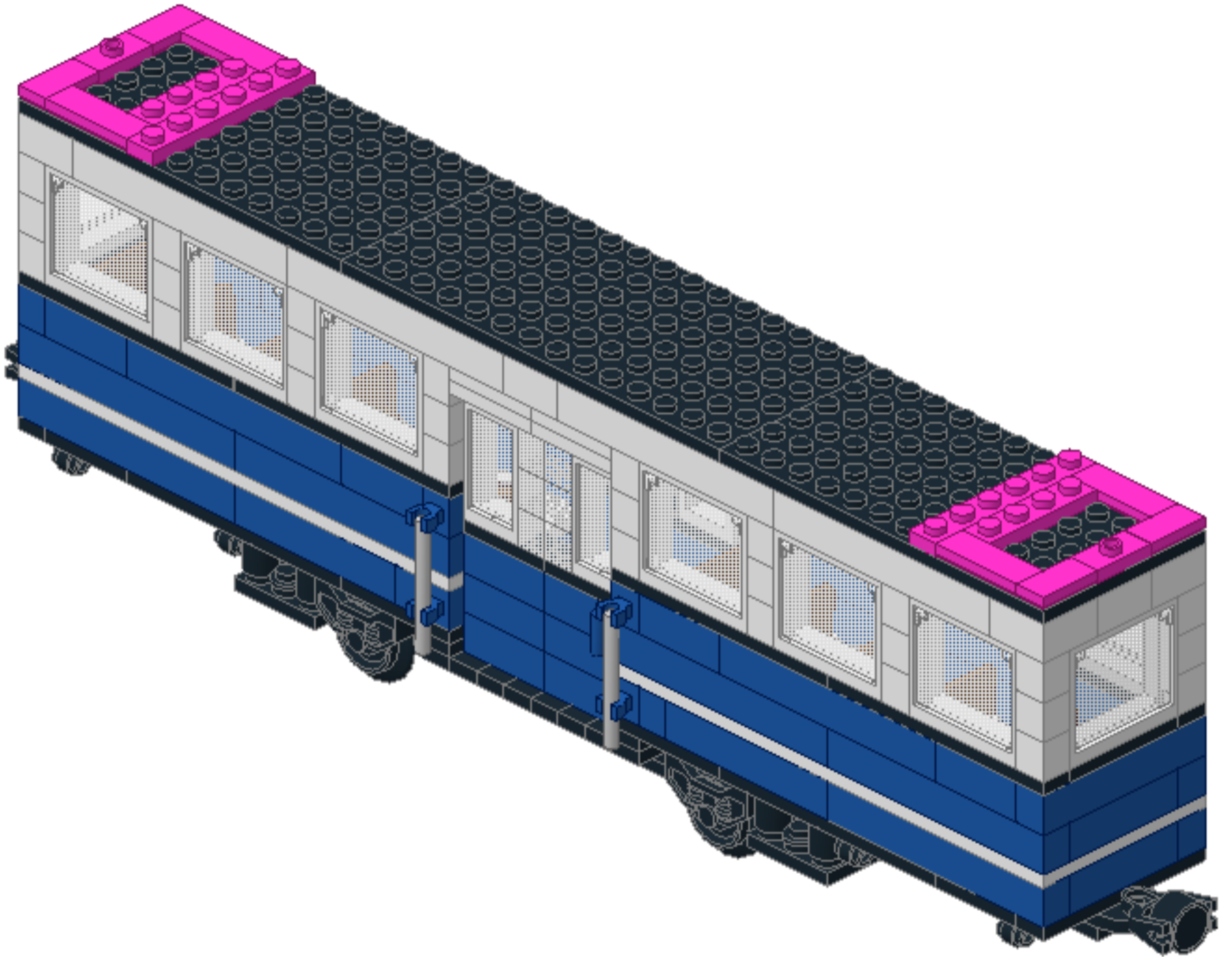
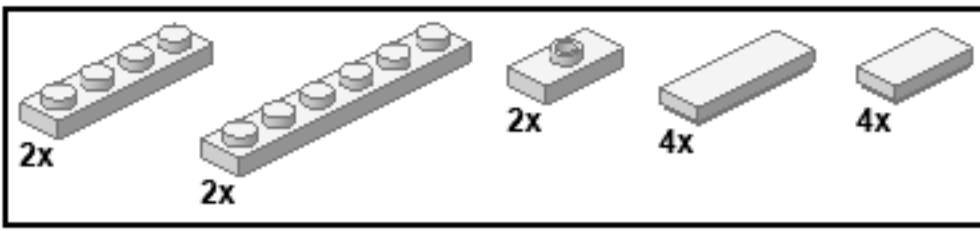

44

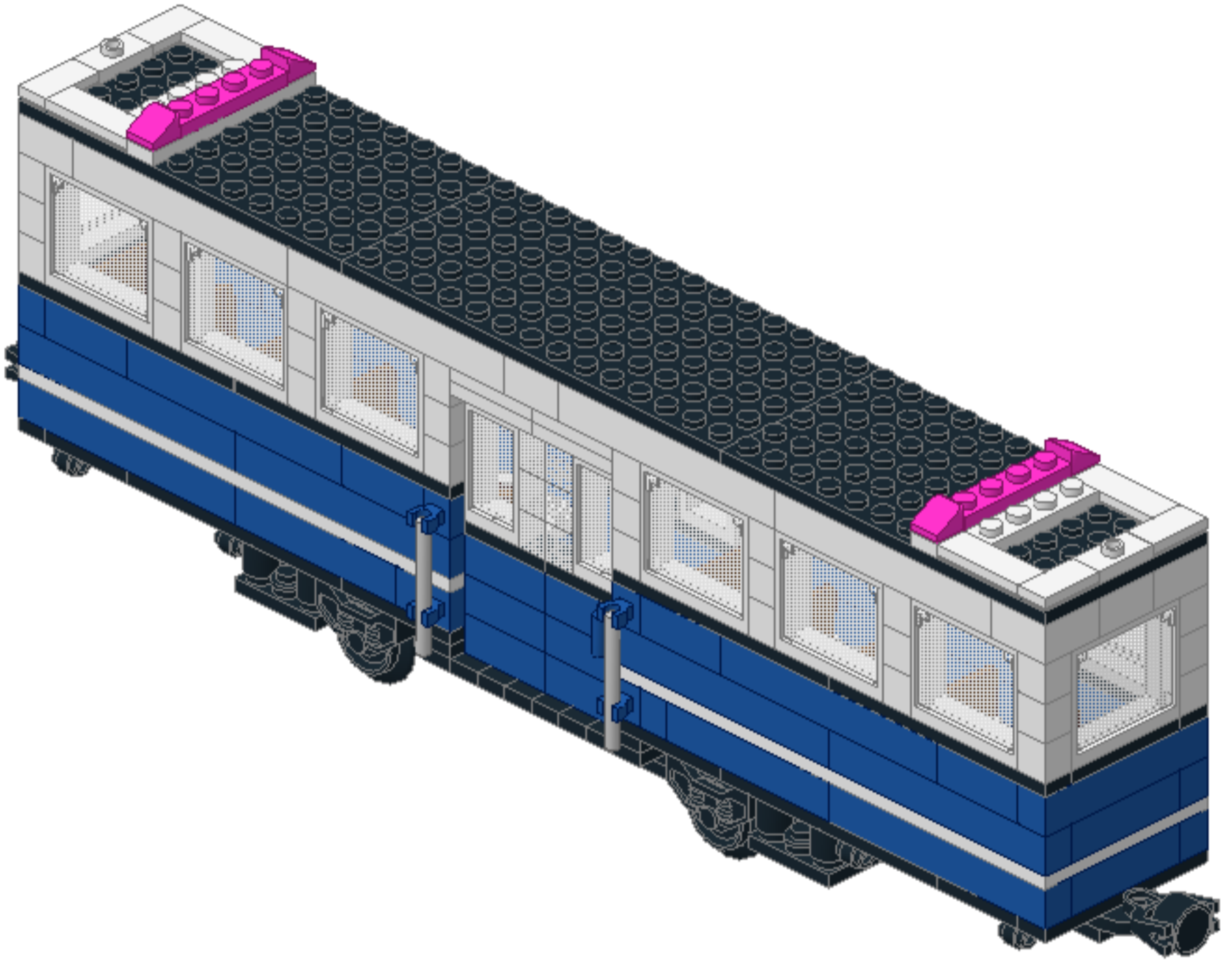
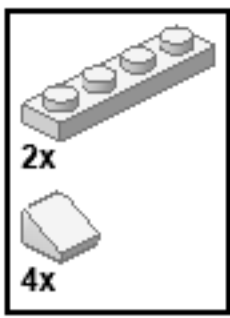

45

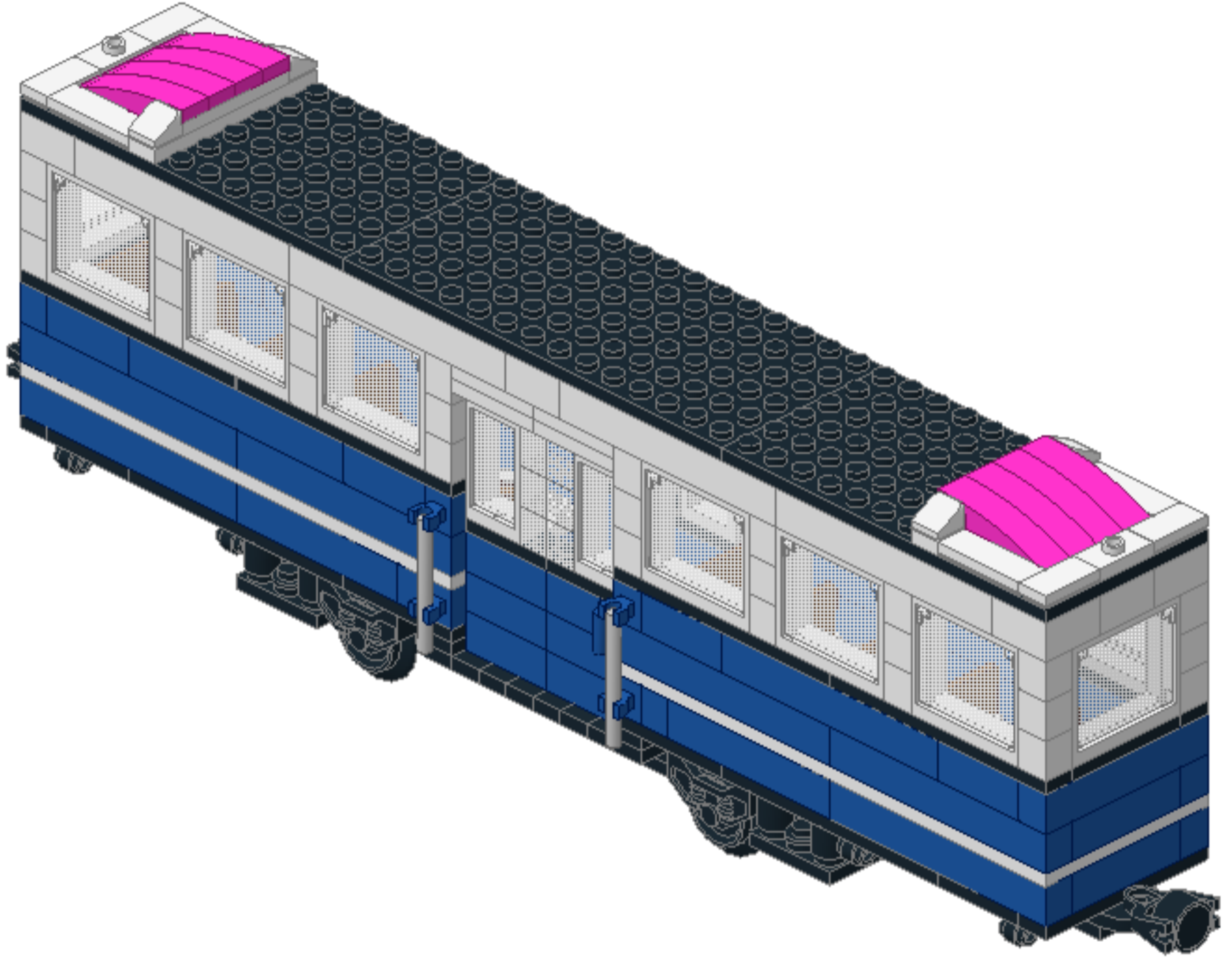
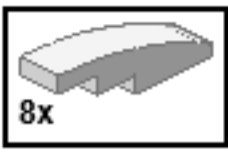

46

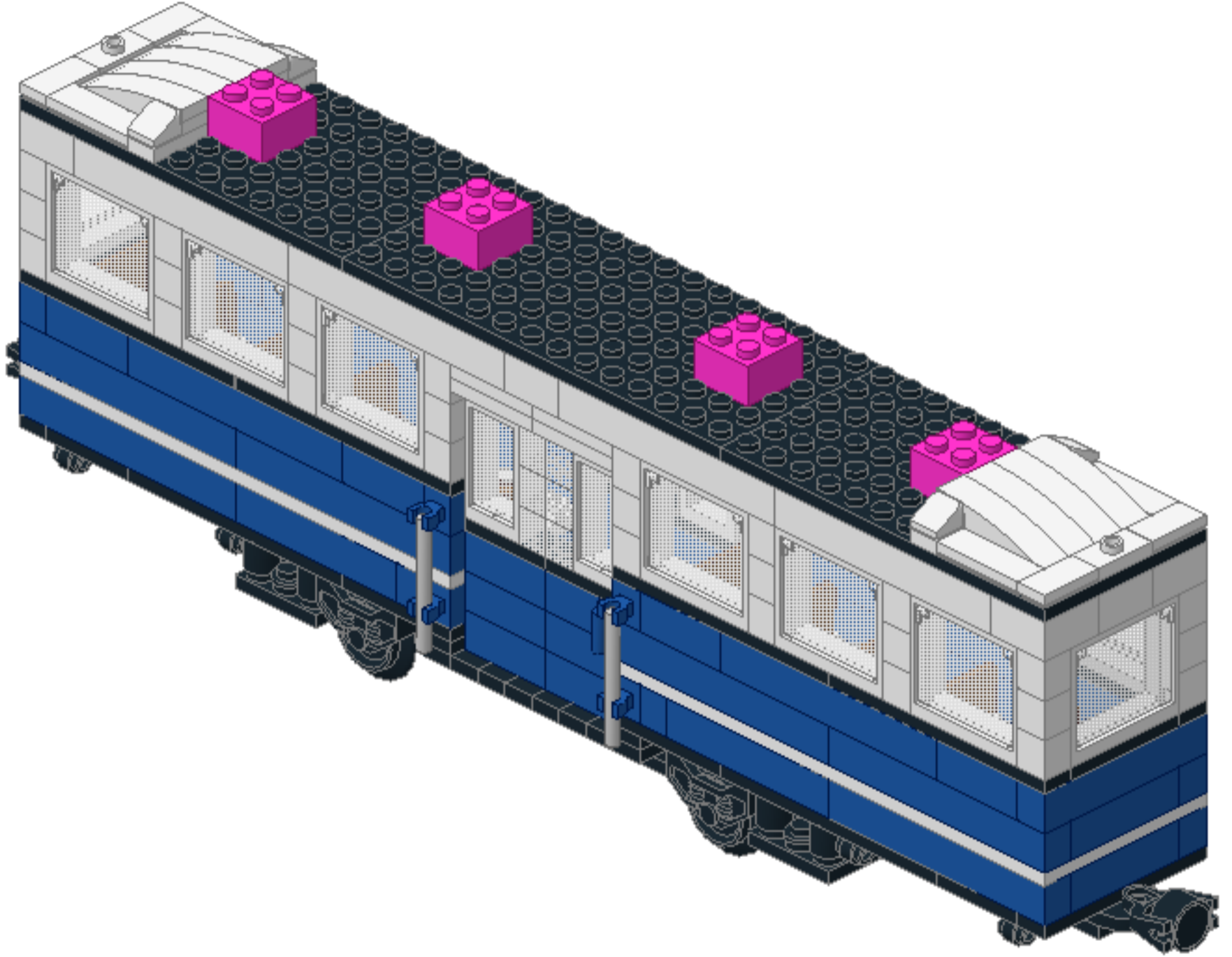
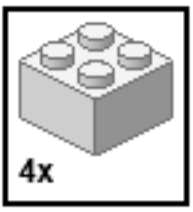

47

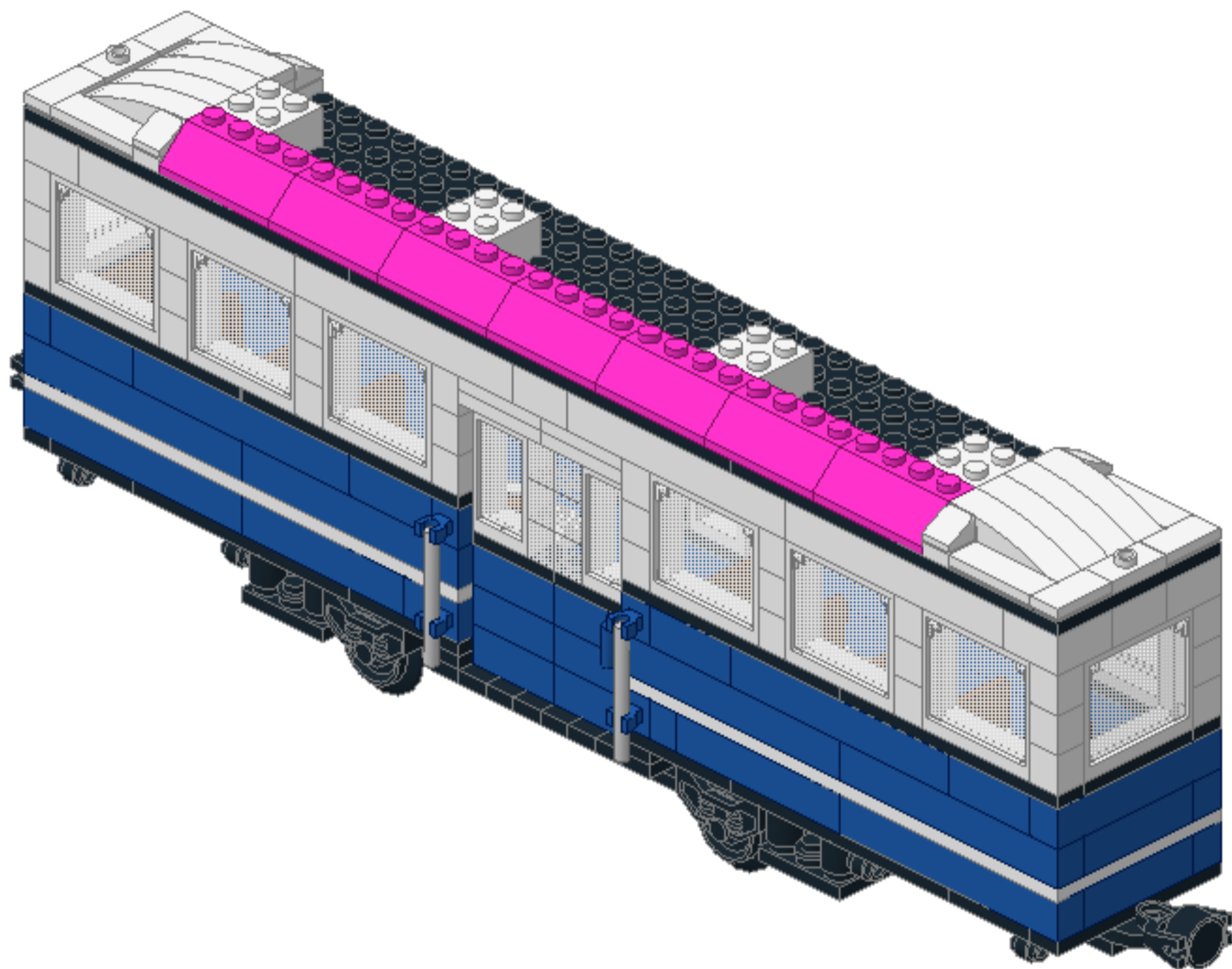
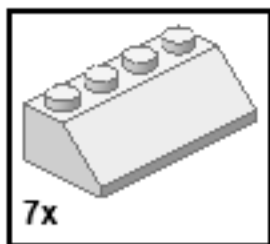

48

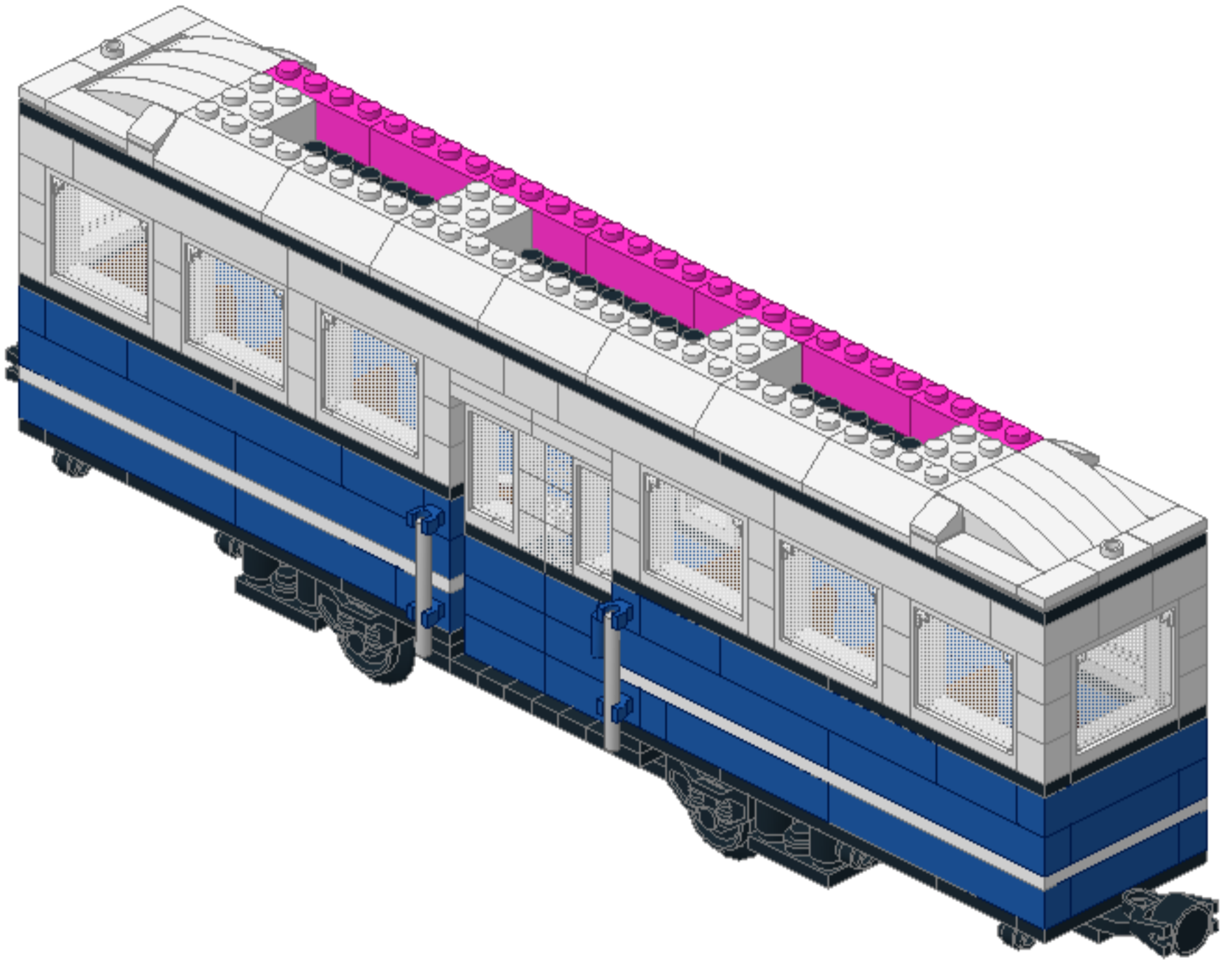
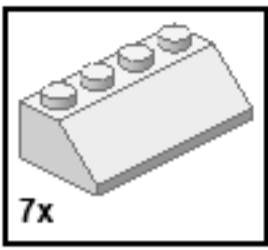

49



x4

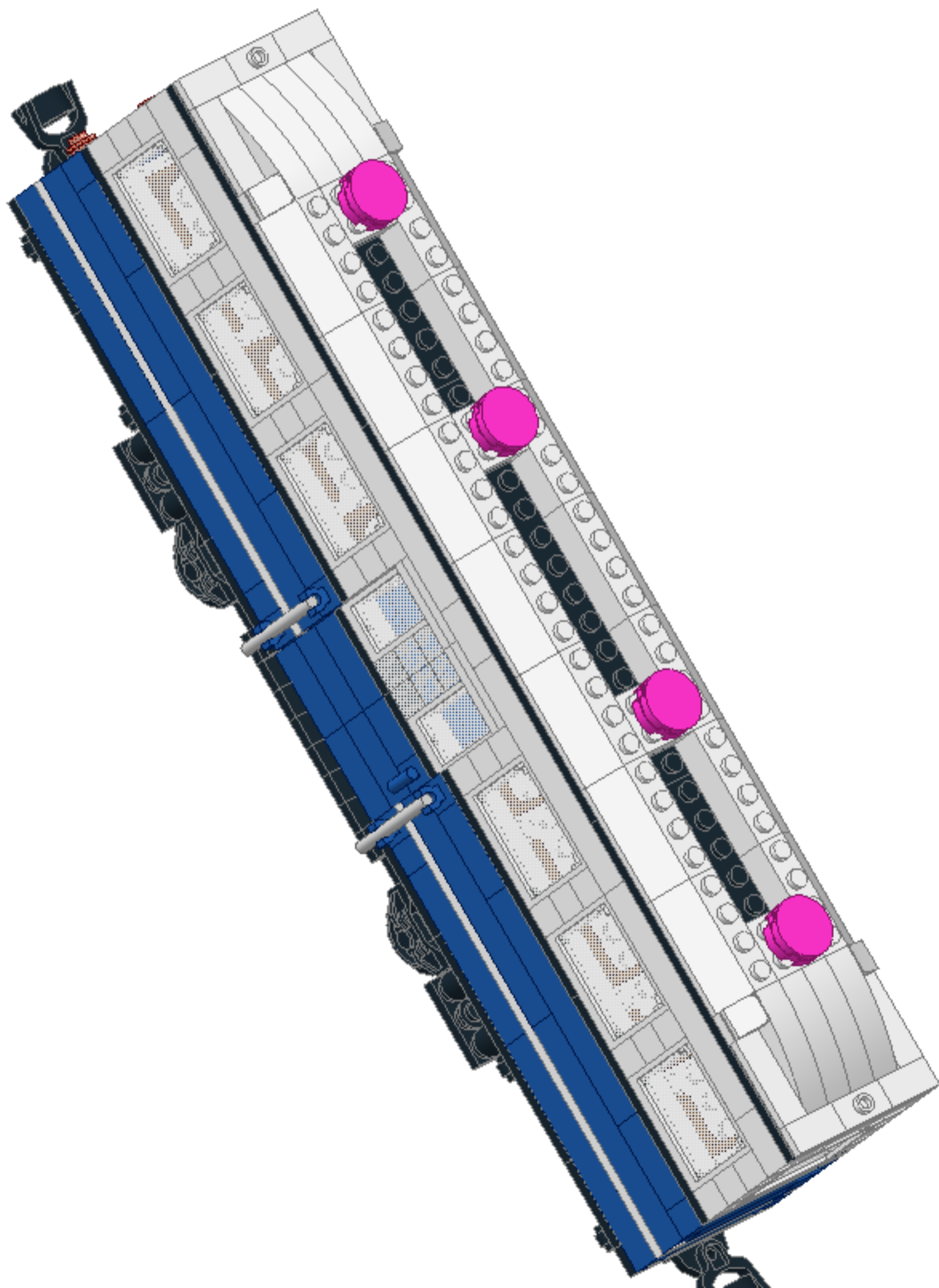

50

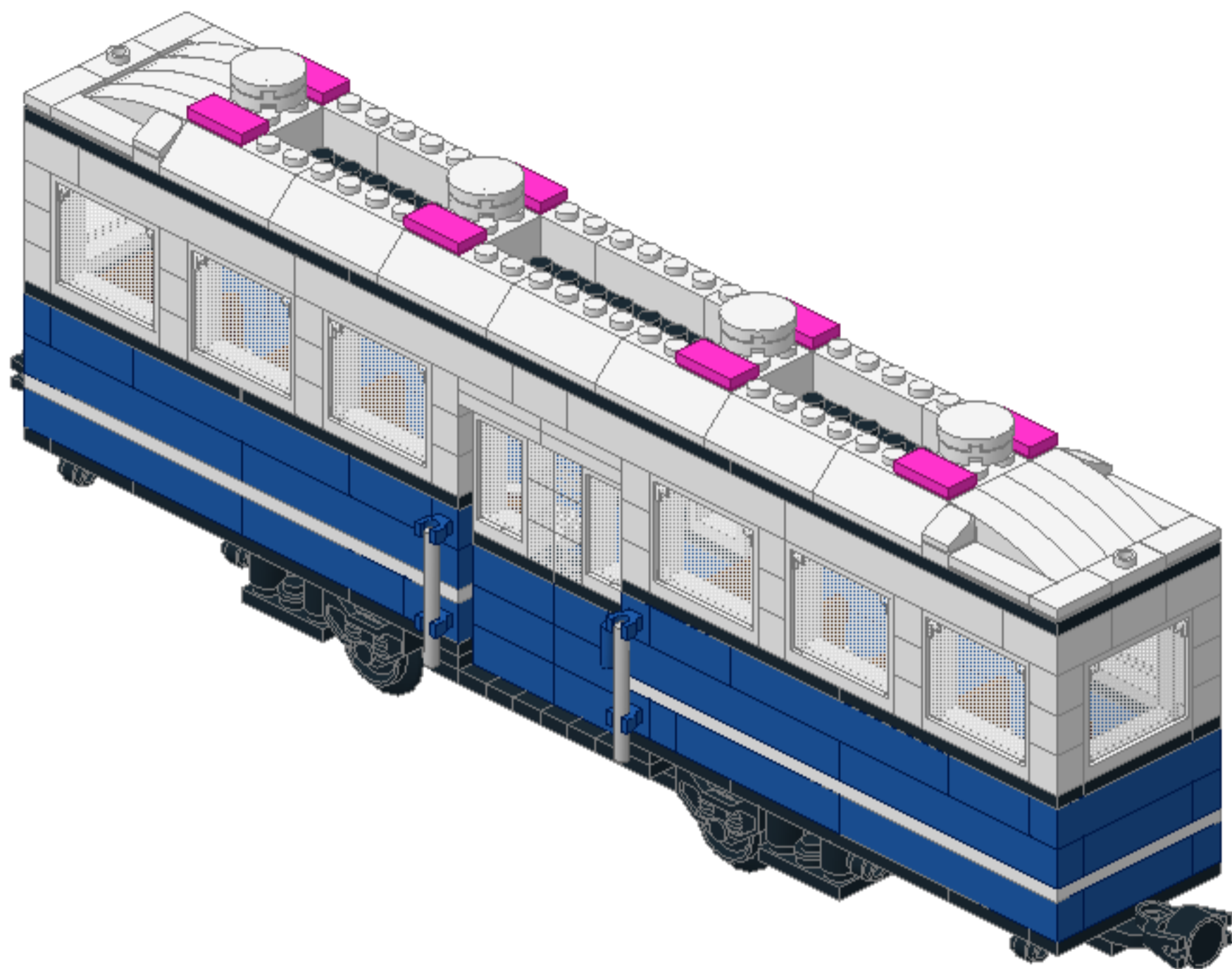
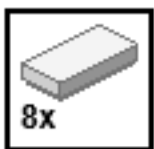

51

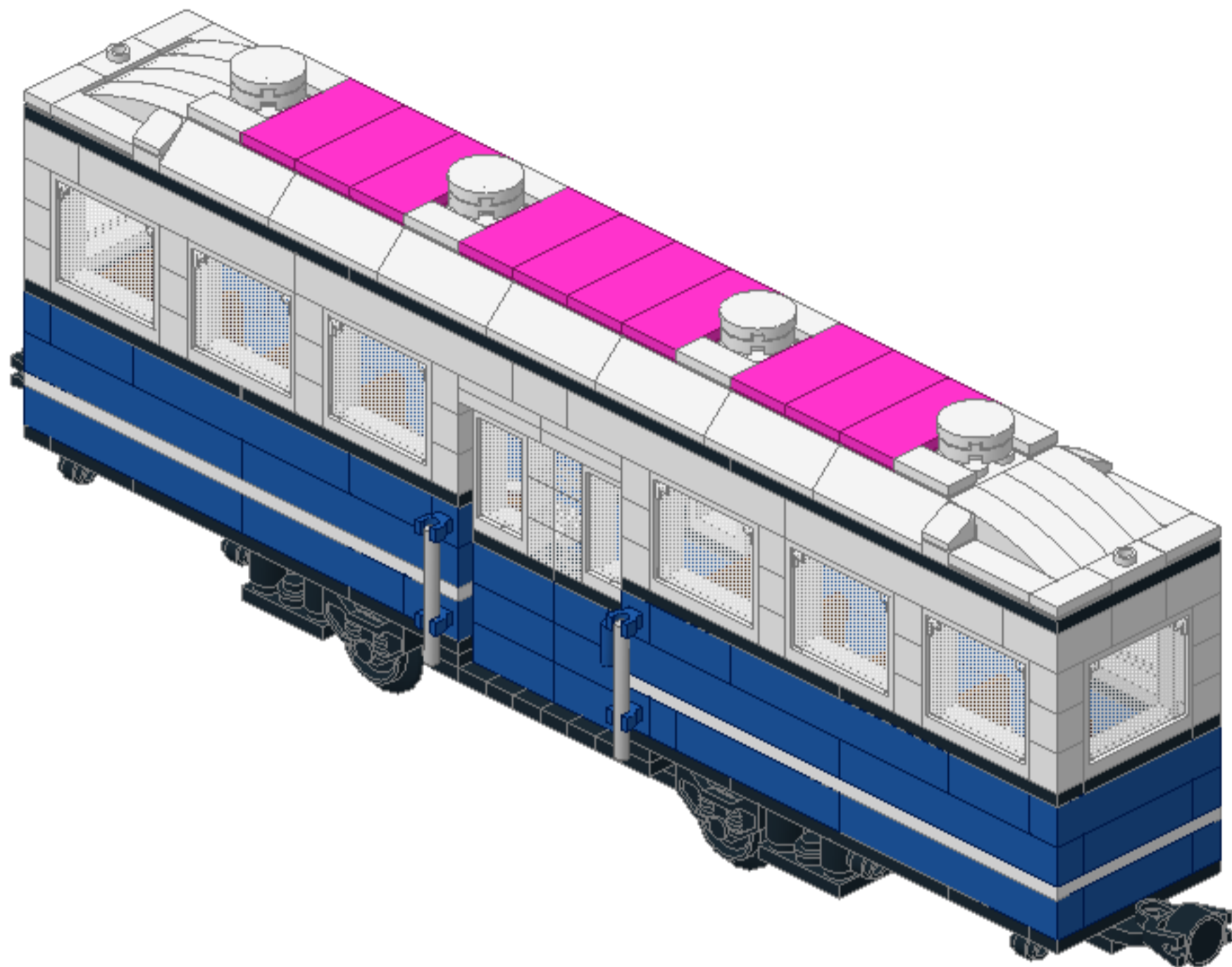
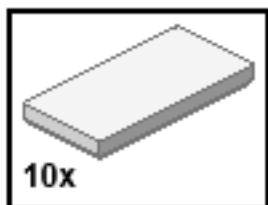

52

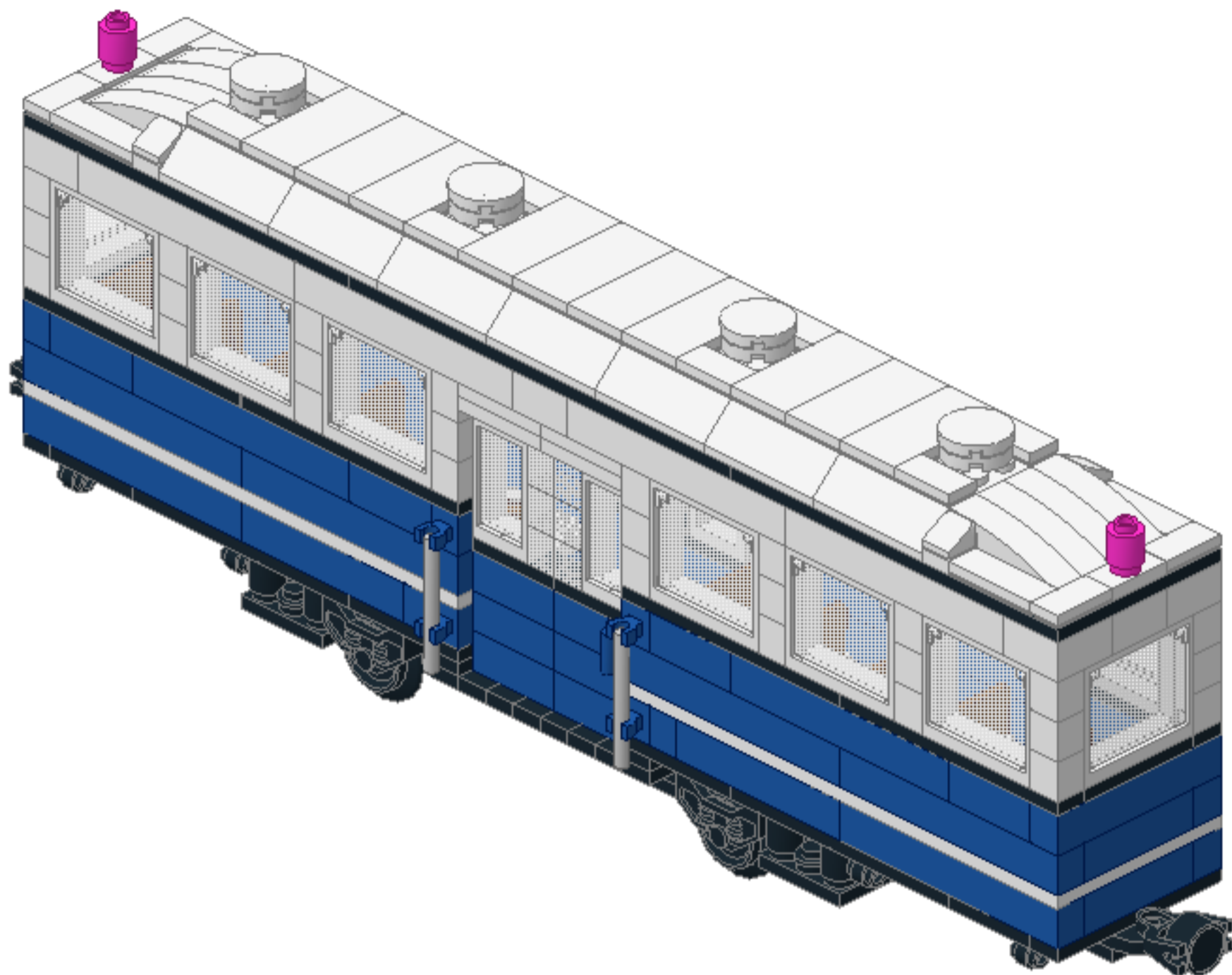
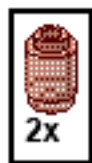

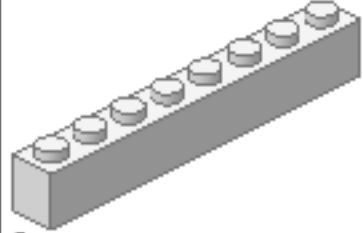

8x



4x



4x

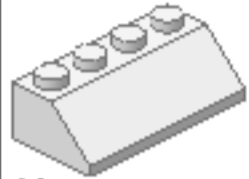

14x



8x



8x

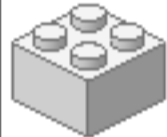

4x



48x



4x

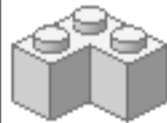

4x



10x

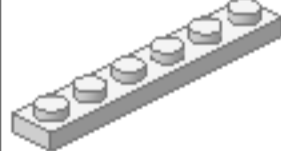

2x

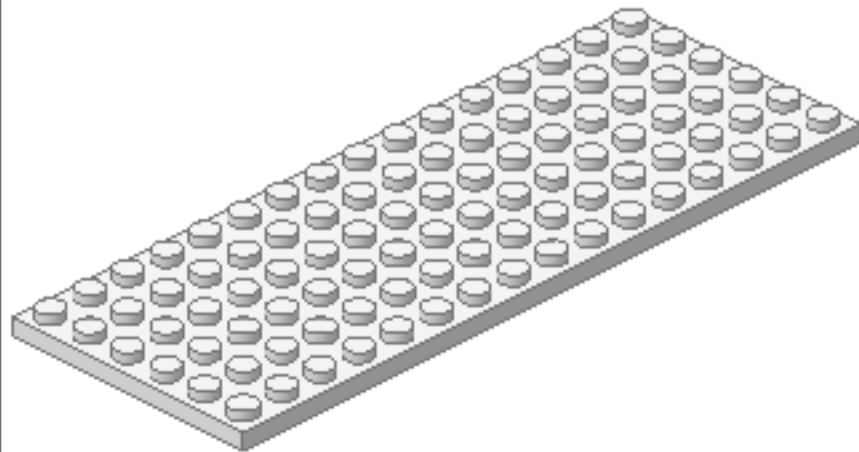

2x



4x

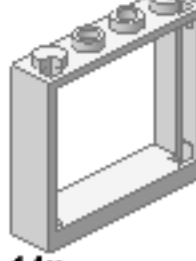

14x

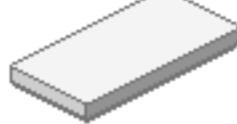

10x



4x



4x



4x



4x



12x



2x

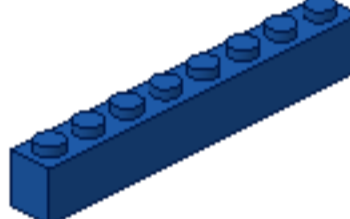

16x



2x

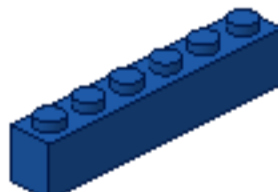

6x

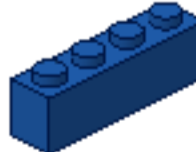

5x



8x



4x



3x

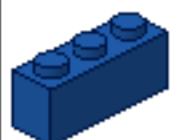

20x

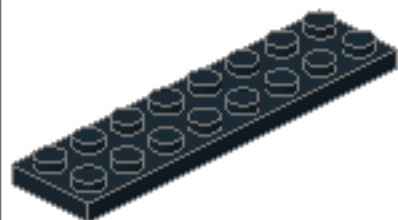

4x

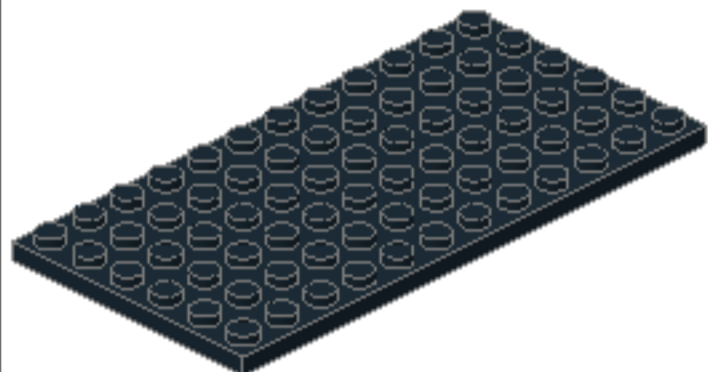

2x



8x

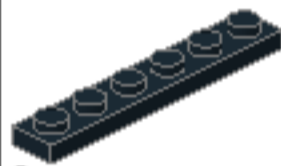

6x



18x



8x

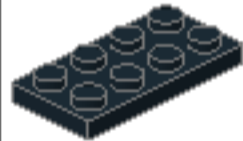

2x



8x

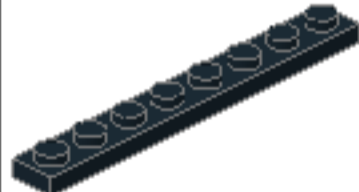

12x

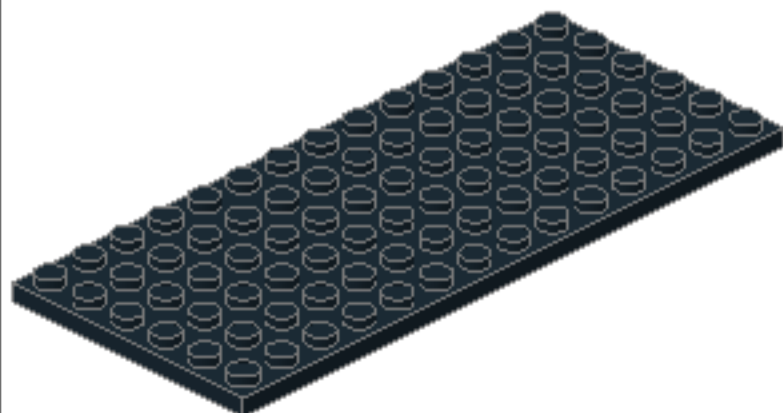

1x



8x

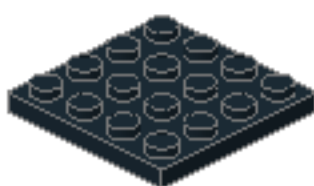

2x

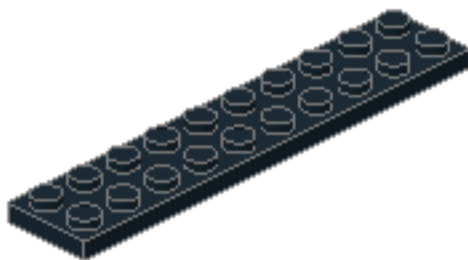

2x

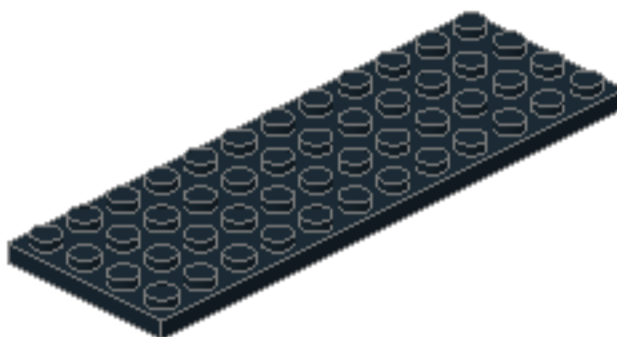

1x



26x



12x



4x



2x



2x



2x



4x

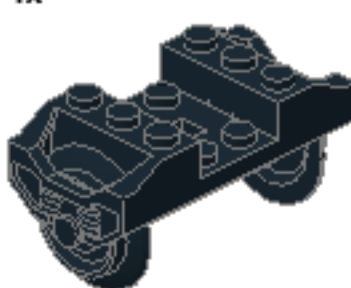

2x



12x



12x

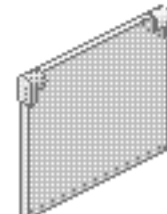

14x

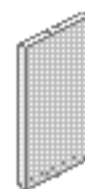

4x



2x



2x



10x



4x