

1

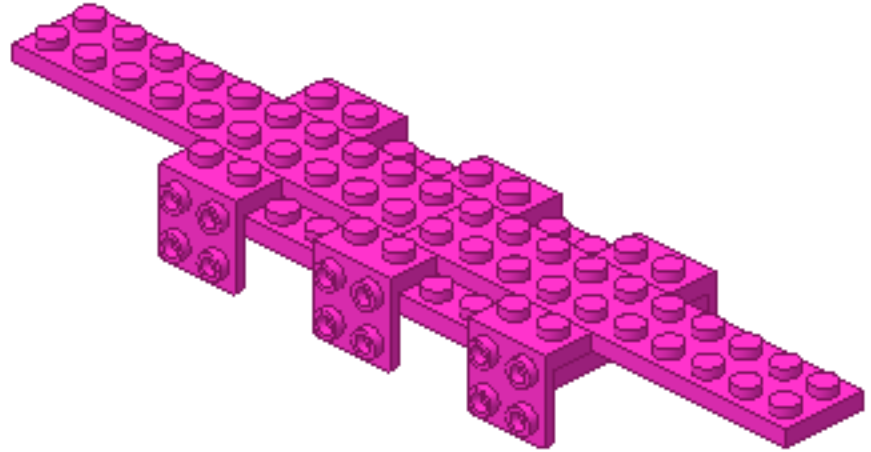

2

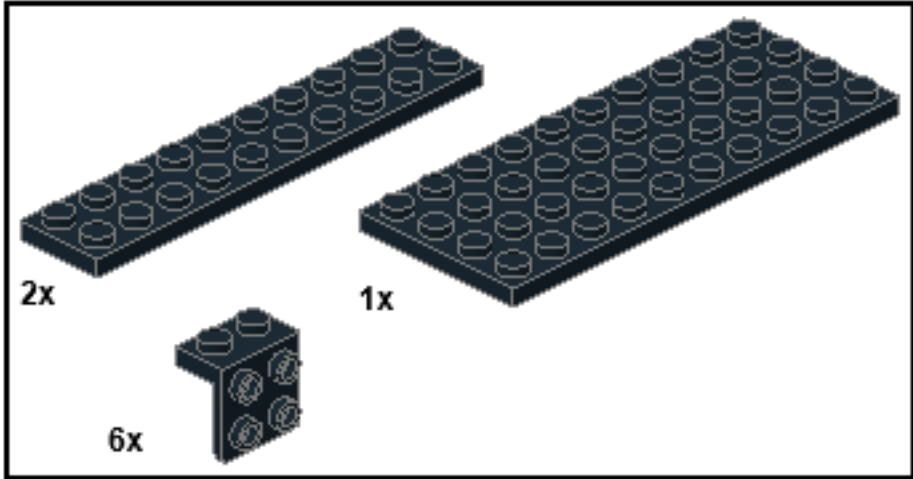
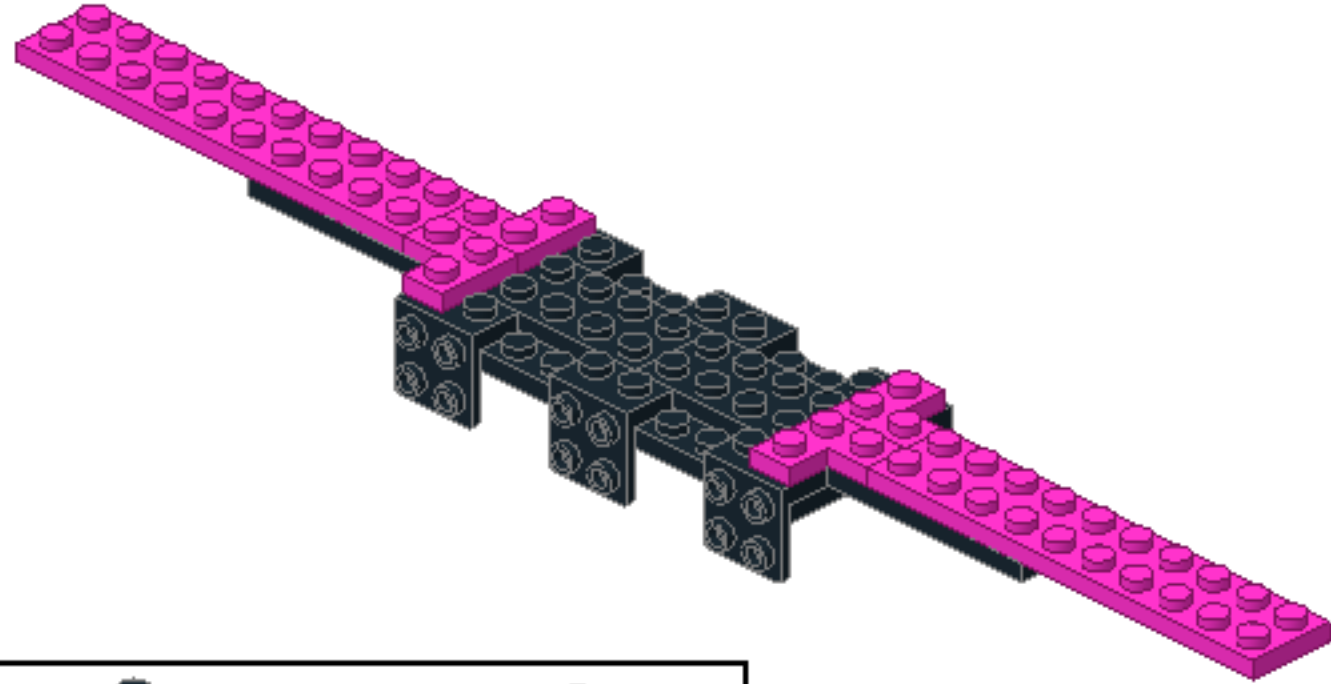
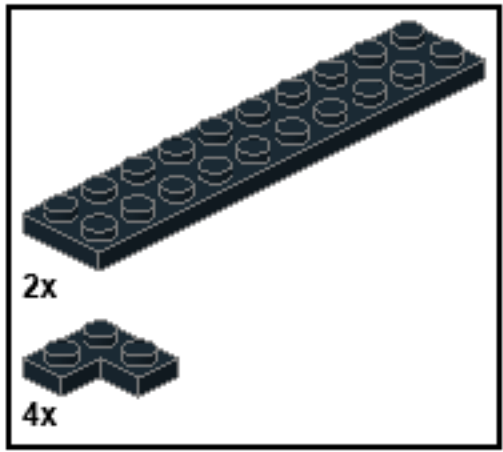

3

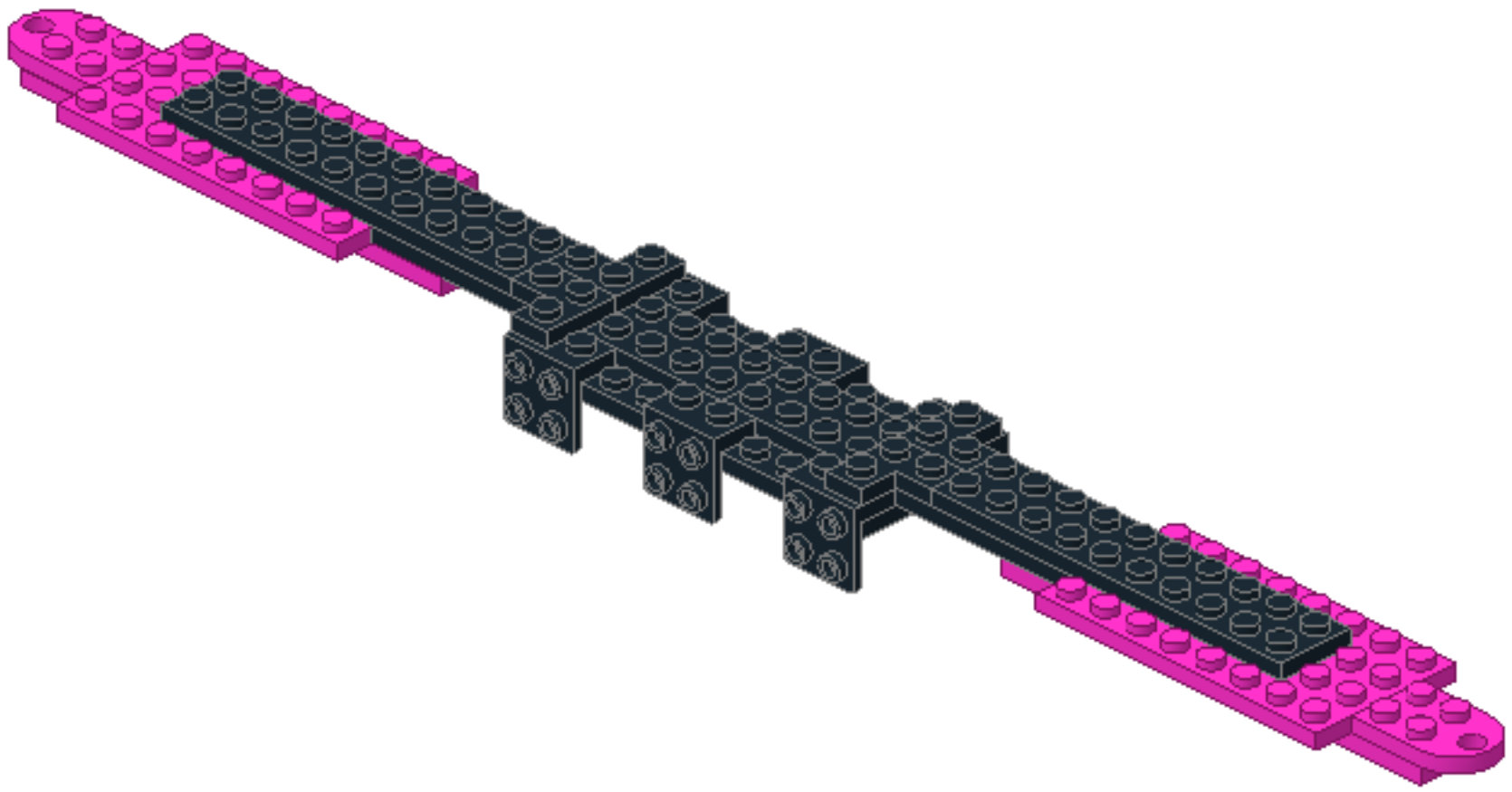
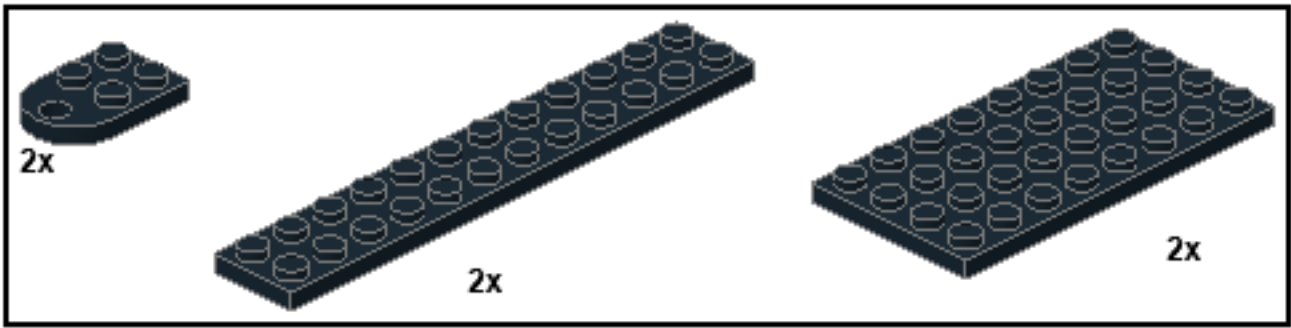



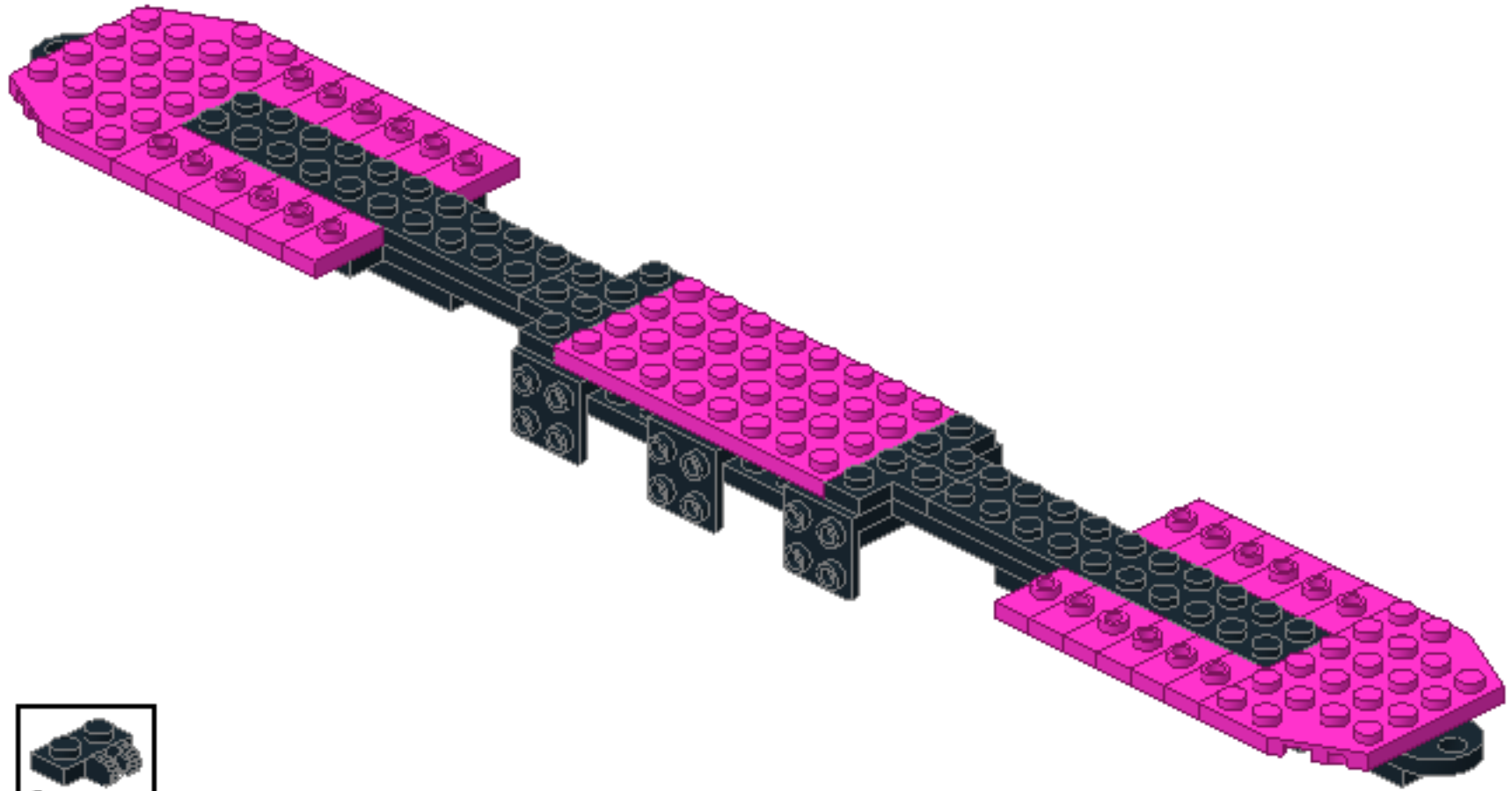
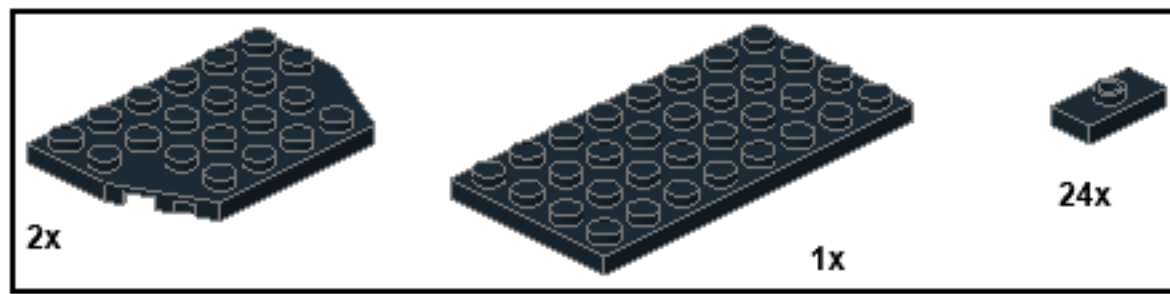

4

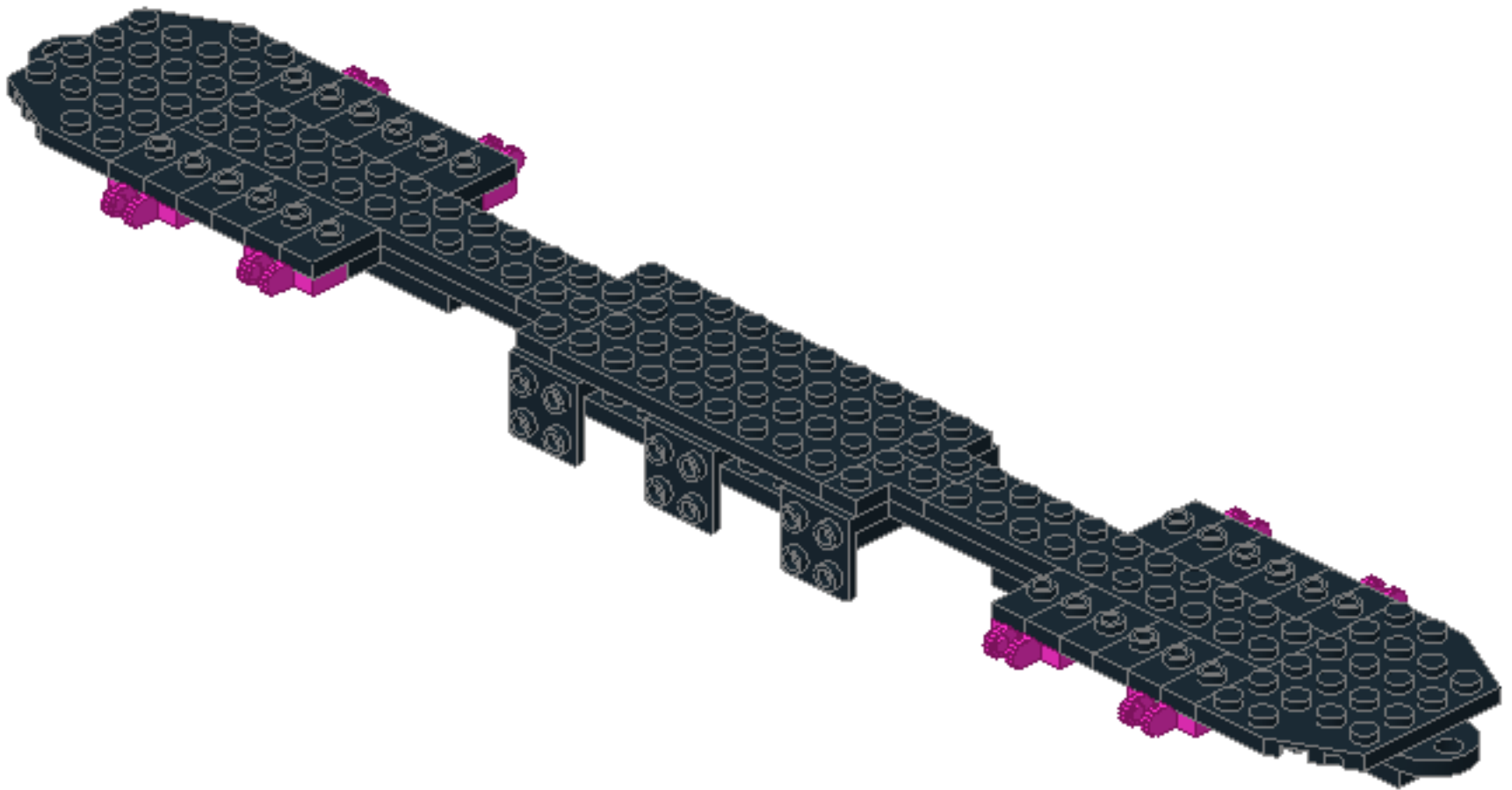

5



6

- 4x 
- 4x 
- 4x 
- 4x 

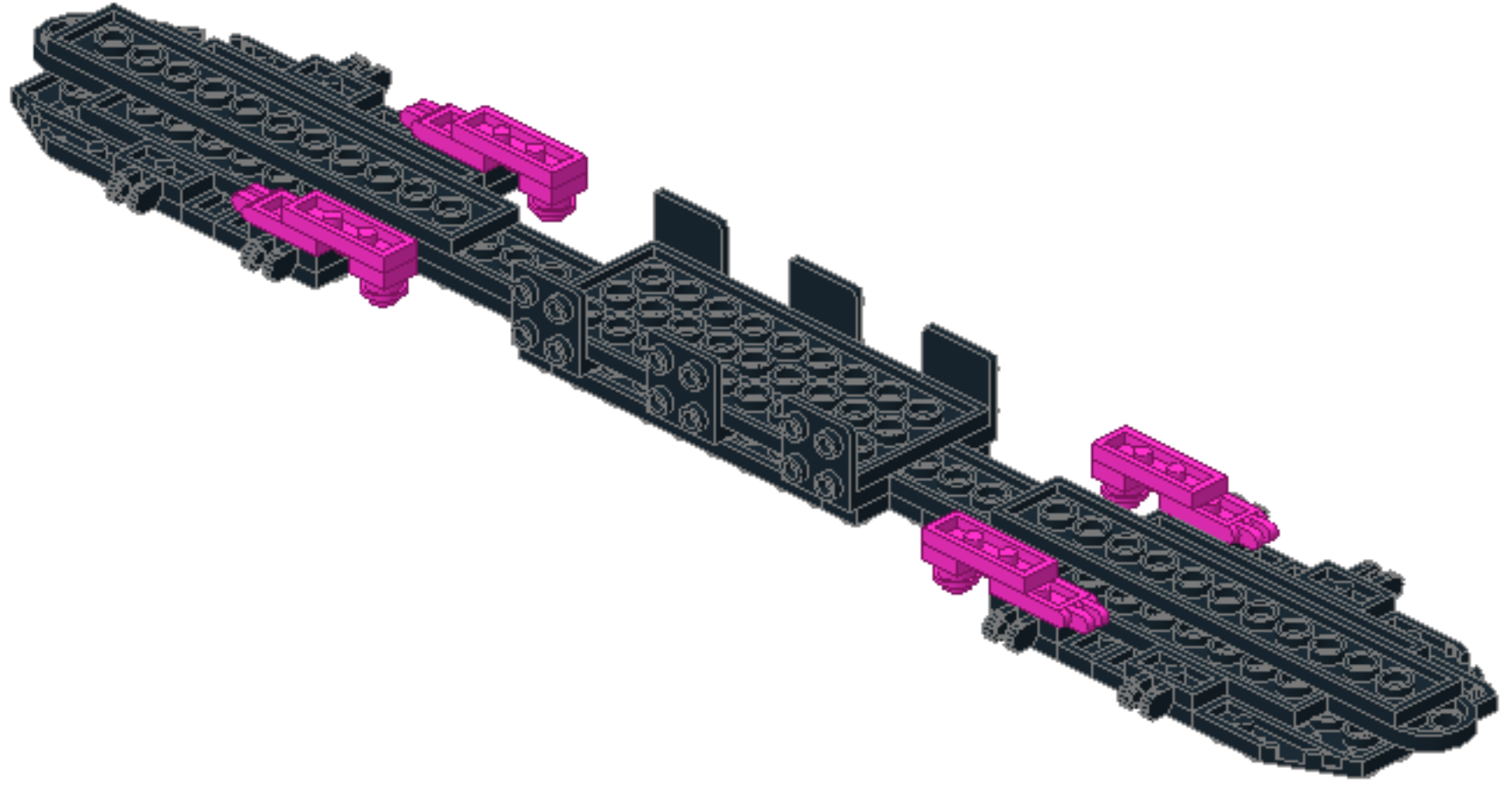
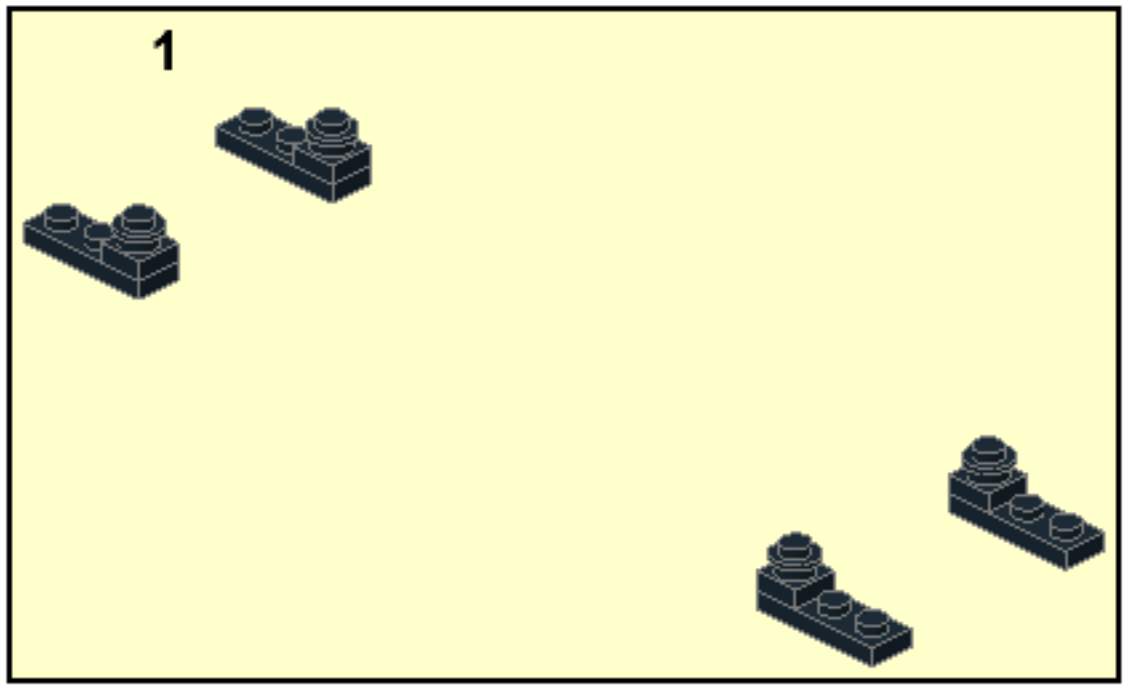

7

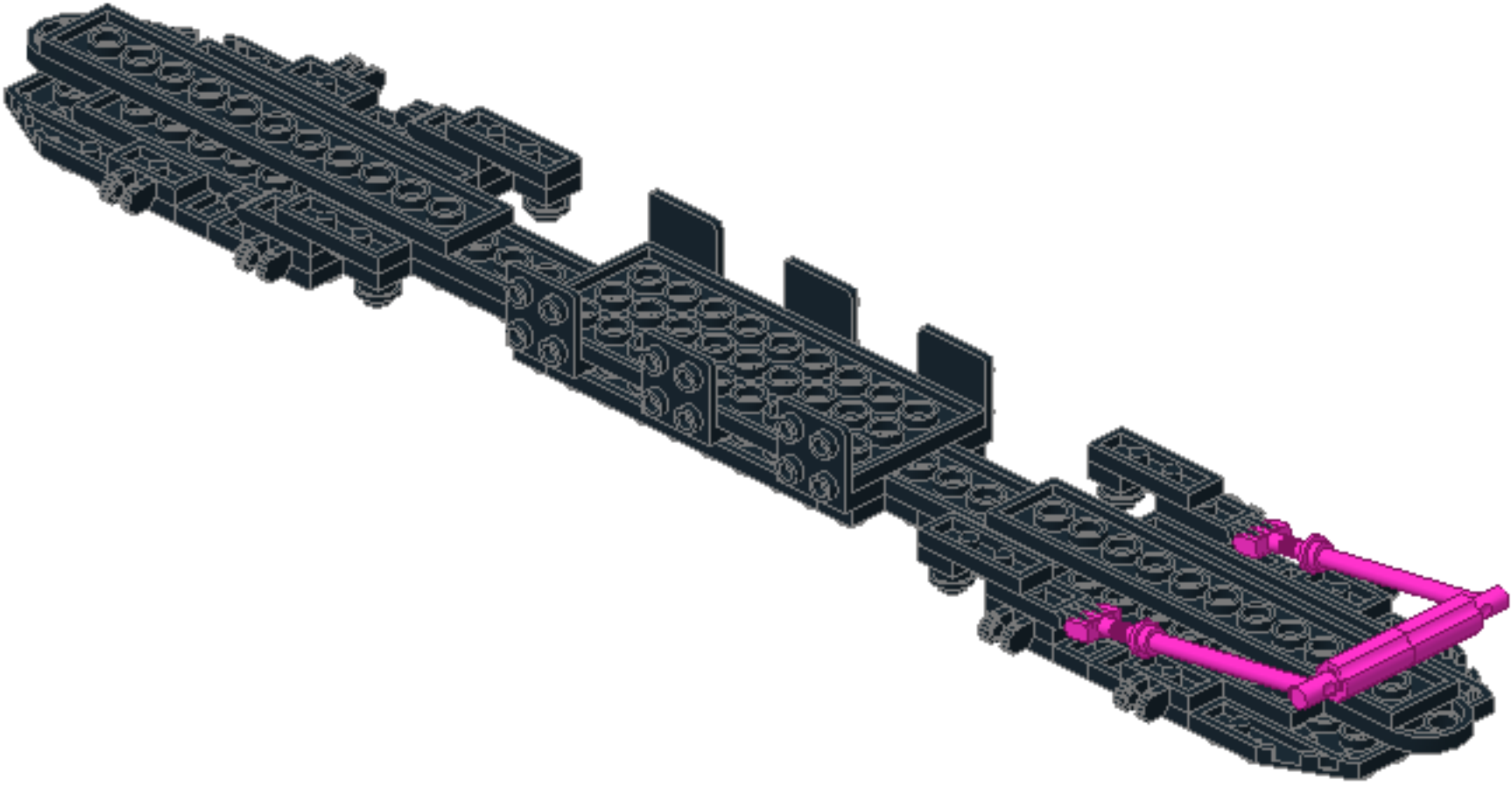
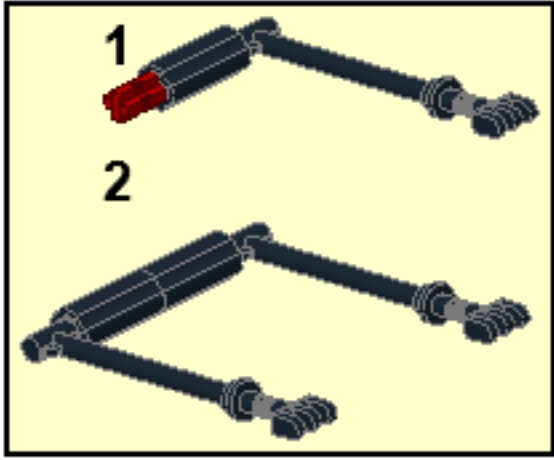
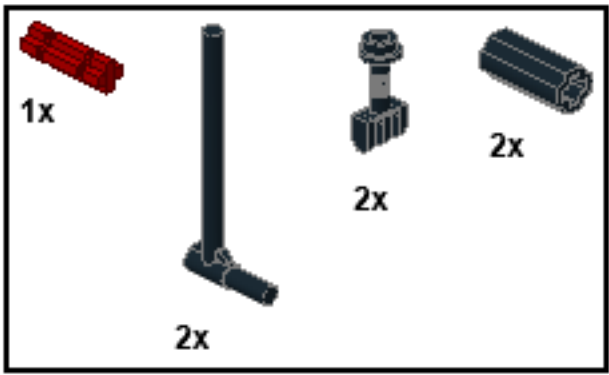

8

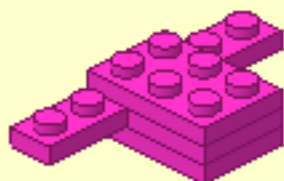
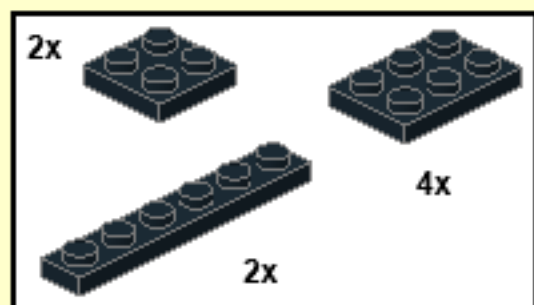
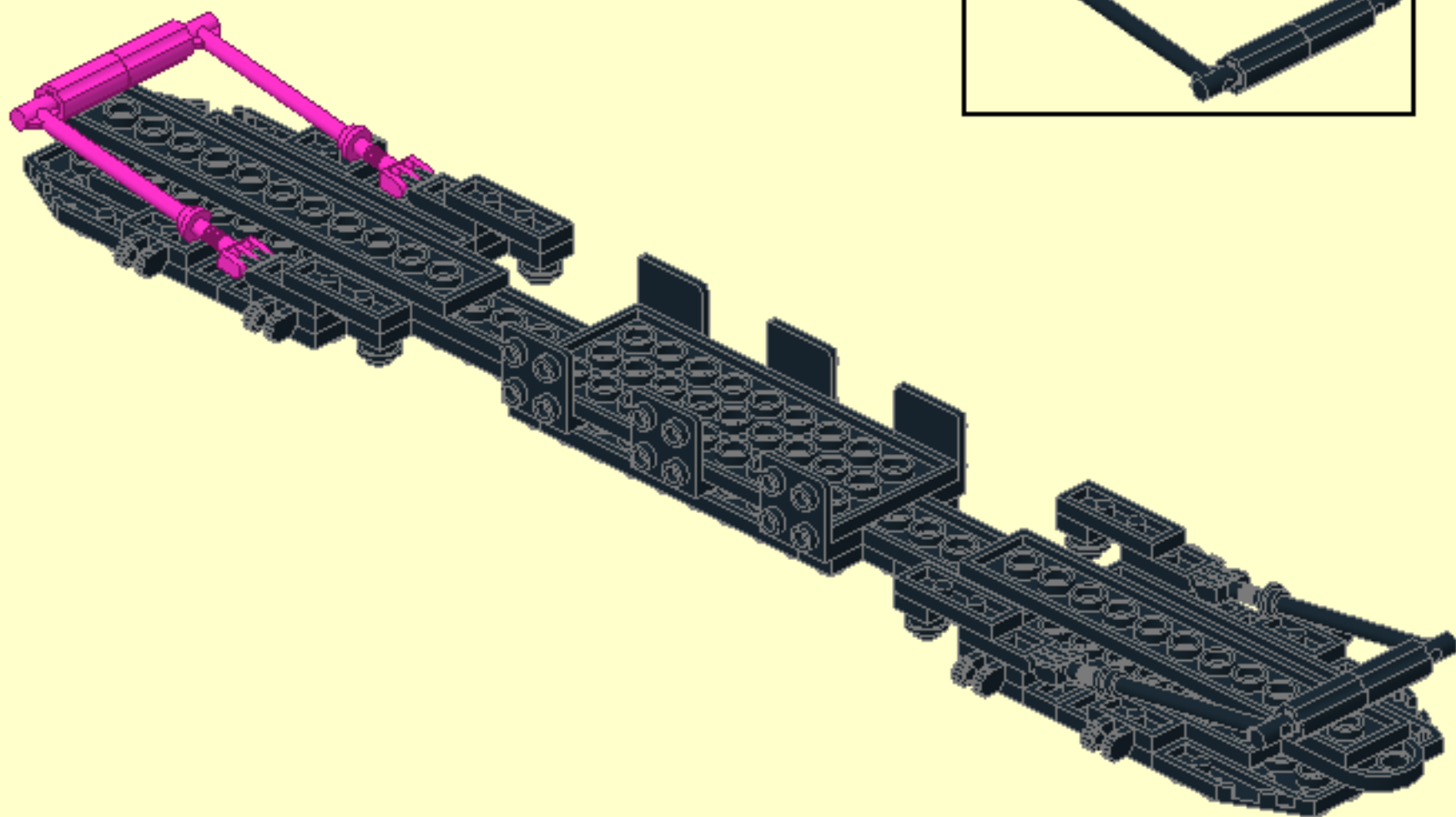
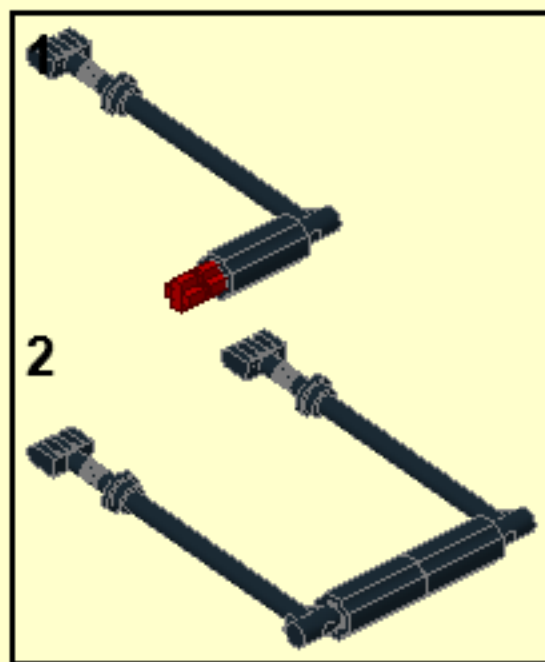
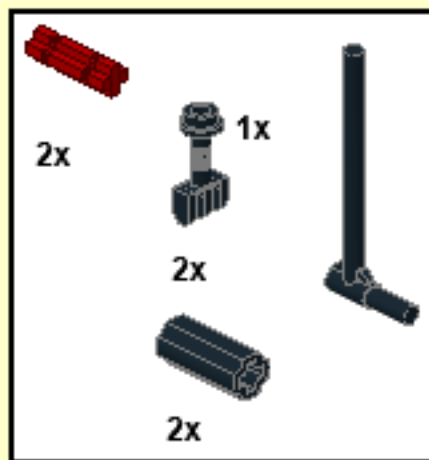

1

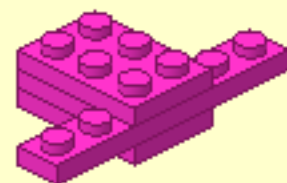



9

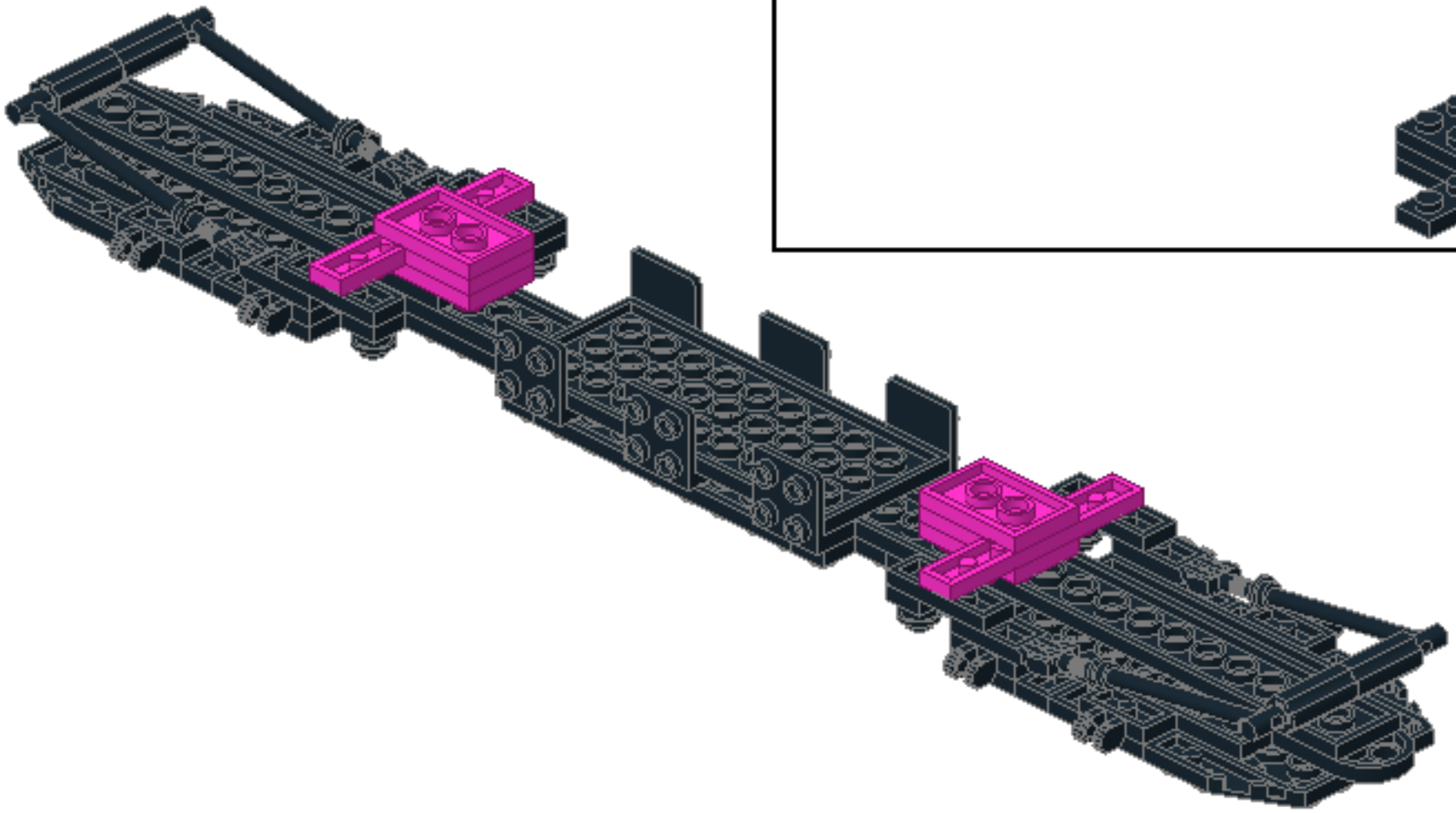
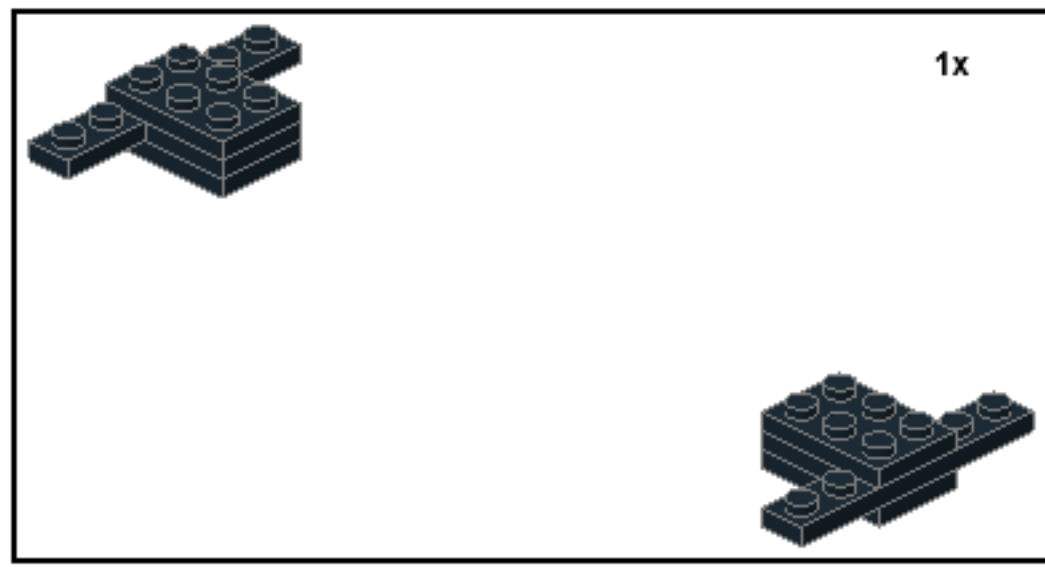

10

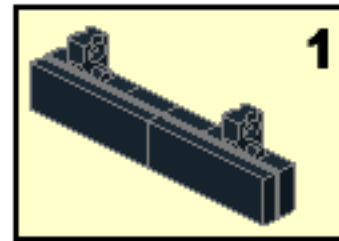

x4

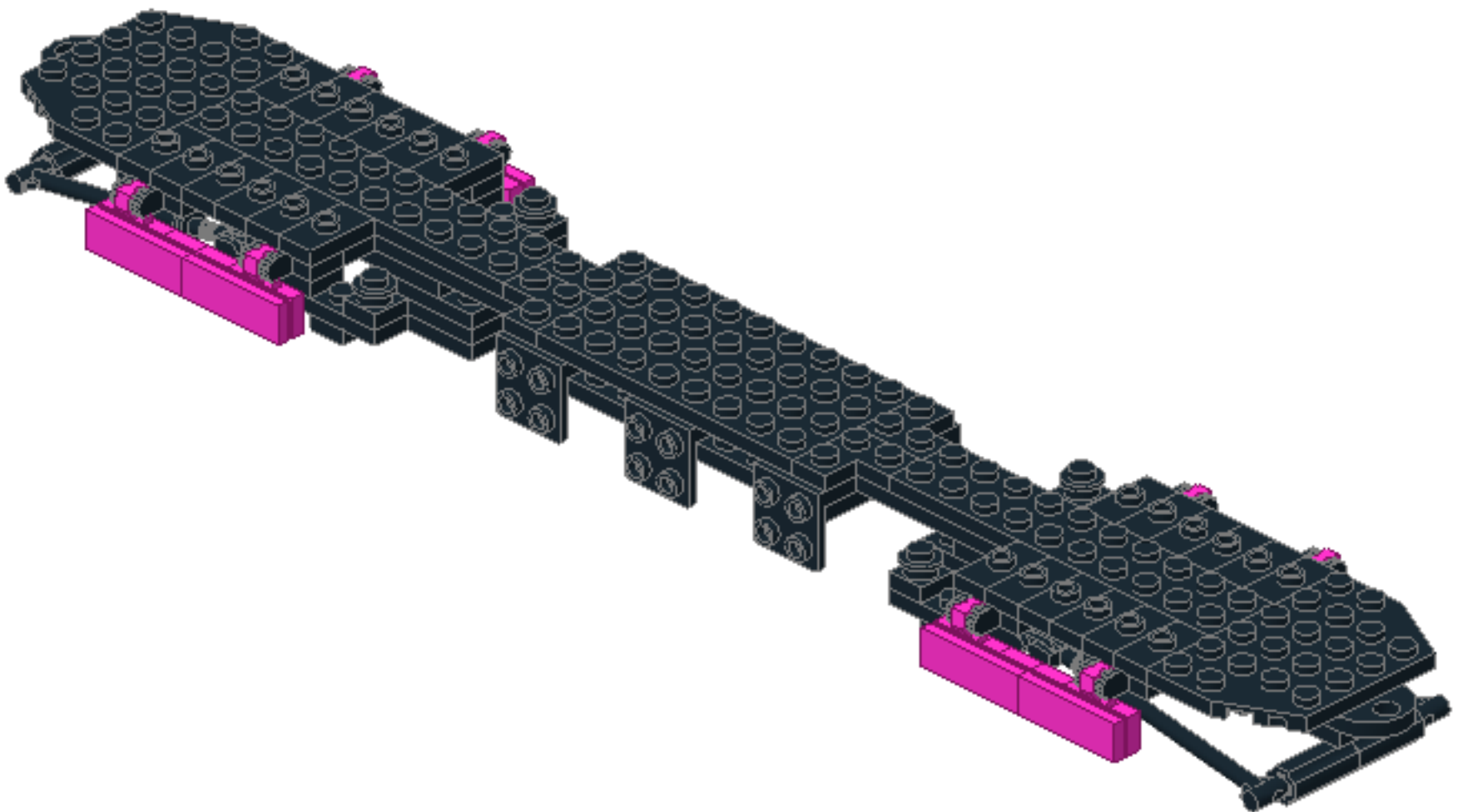

11

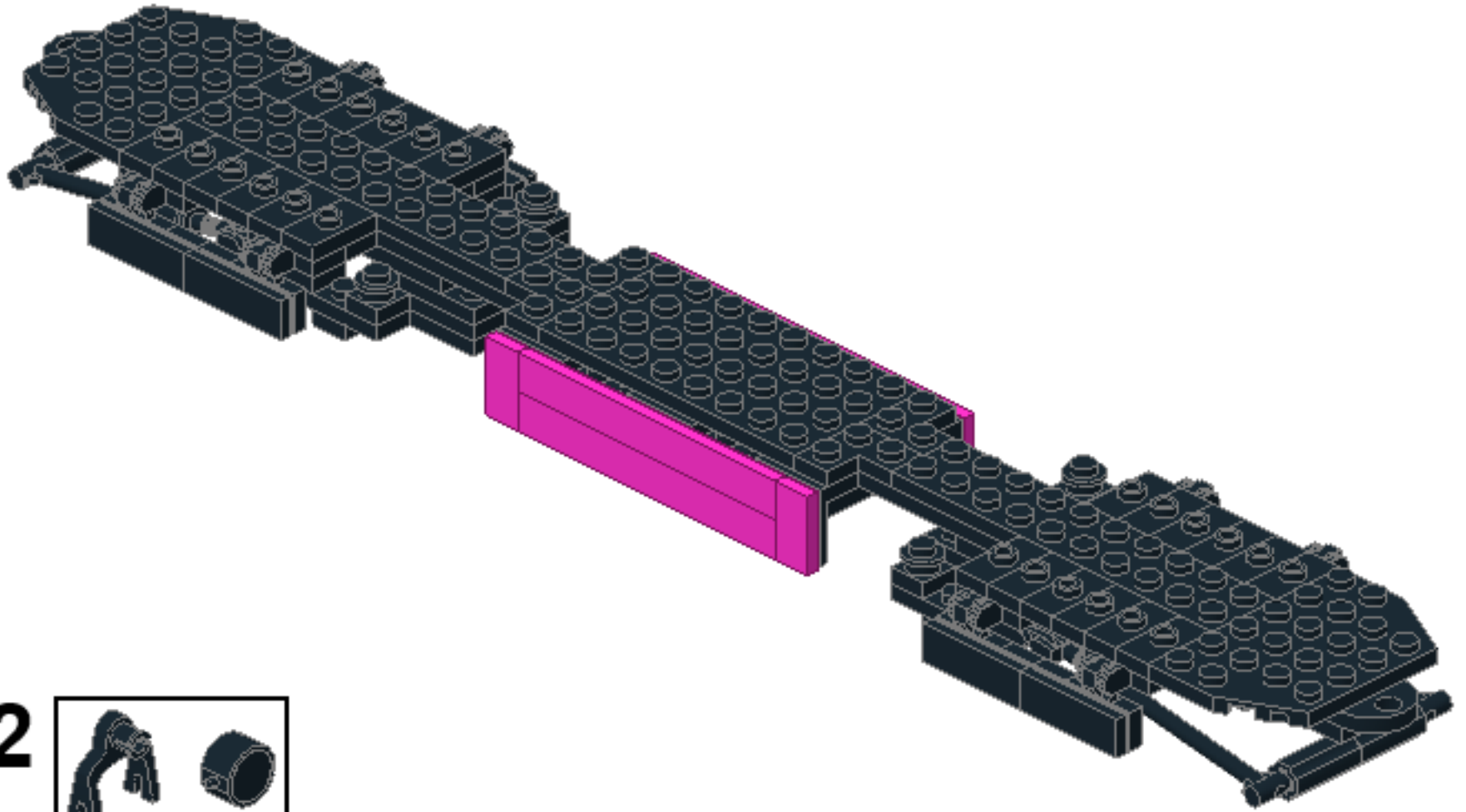
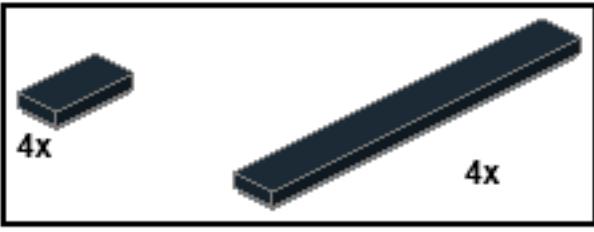

12

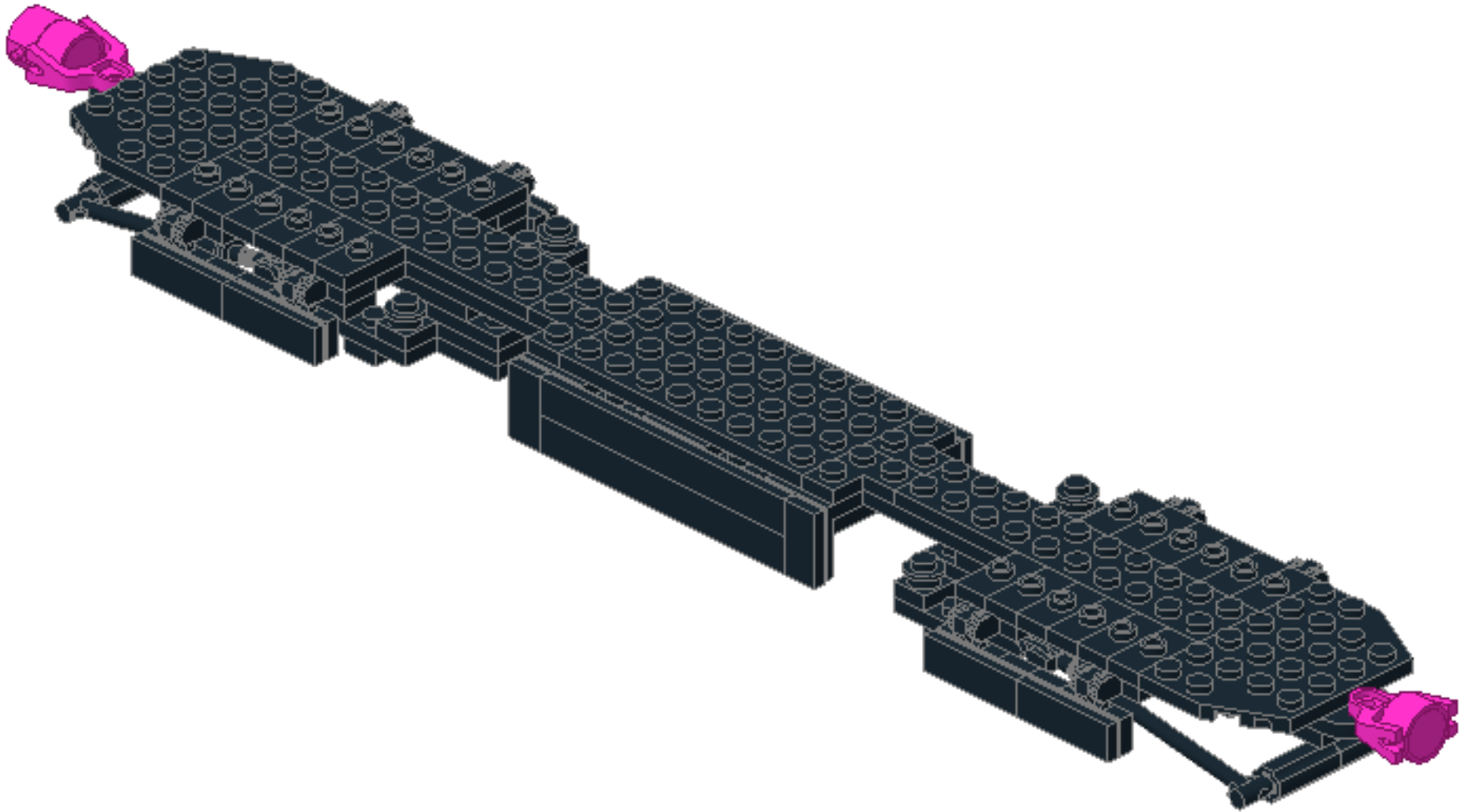
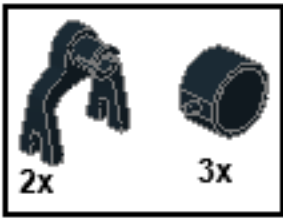

13

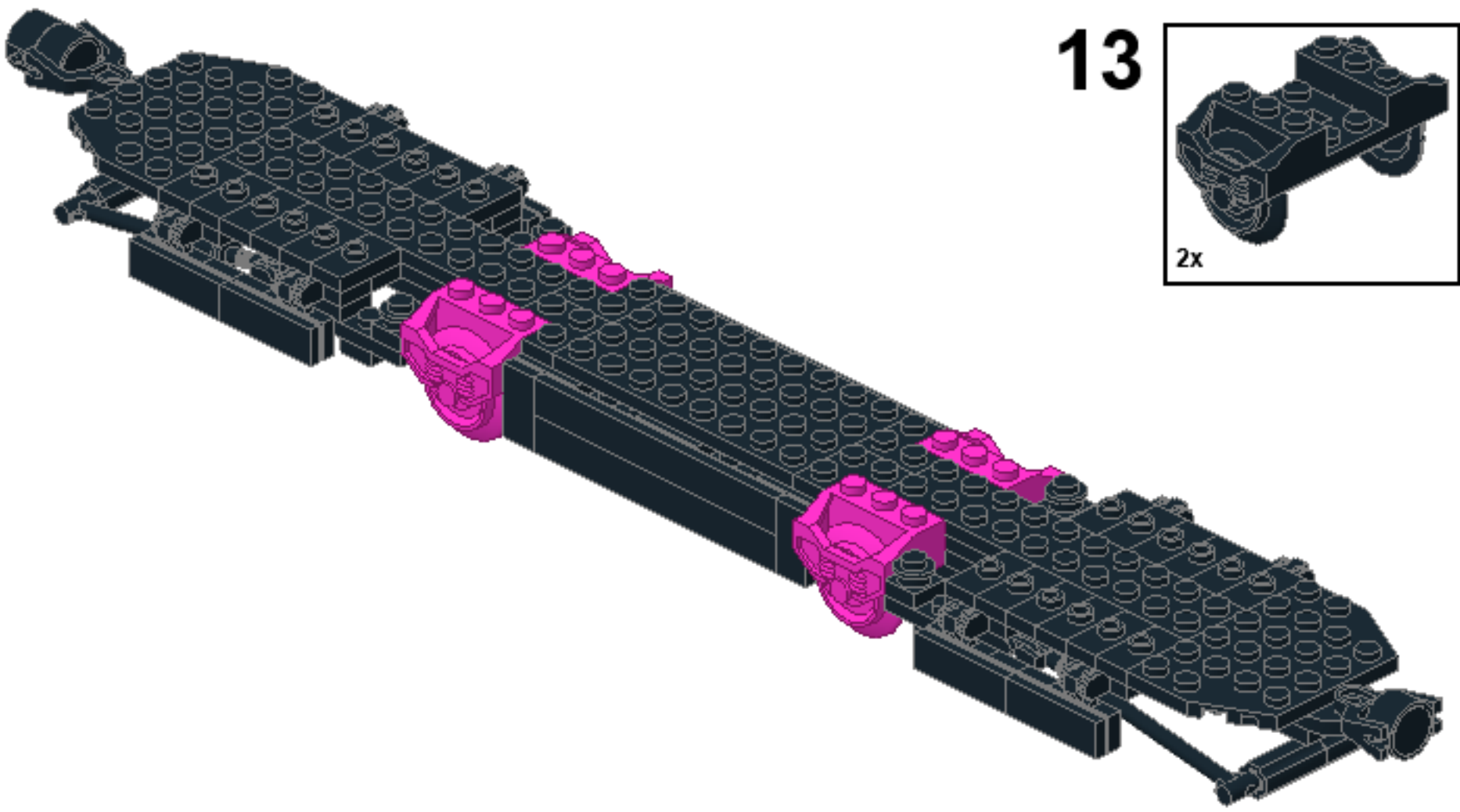
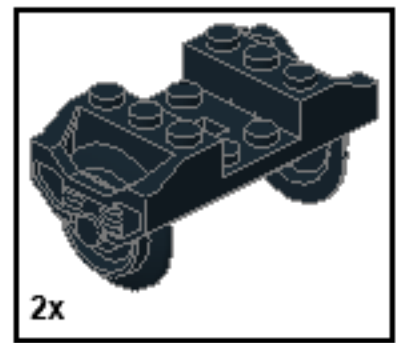

14

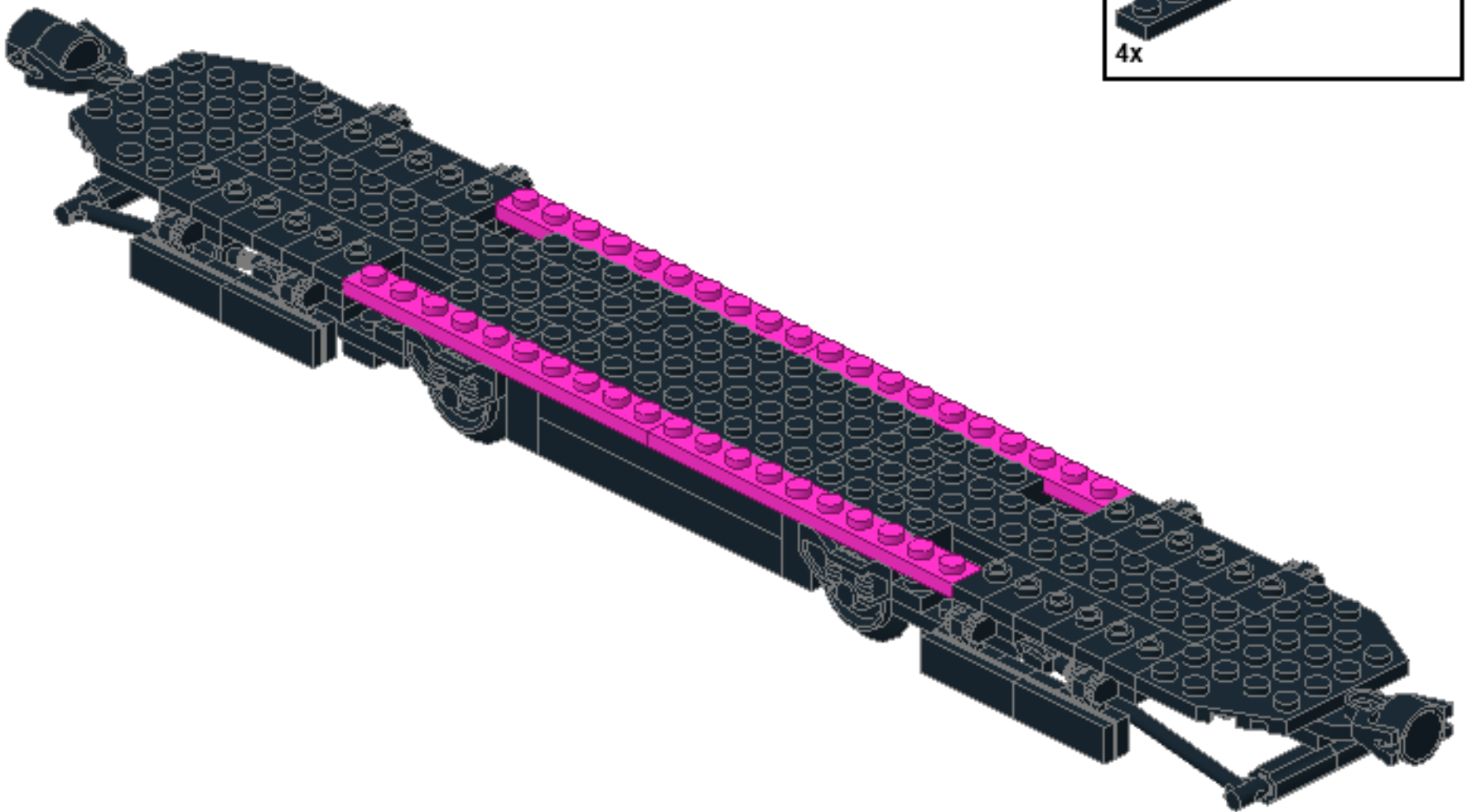
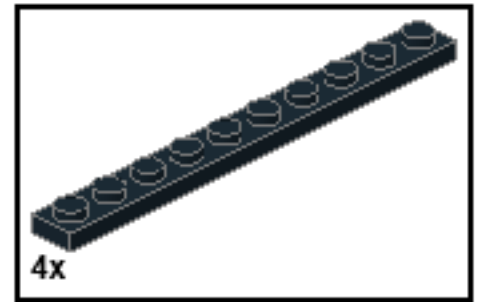



15

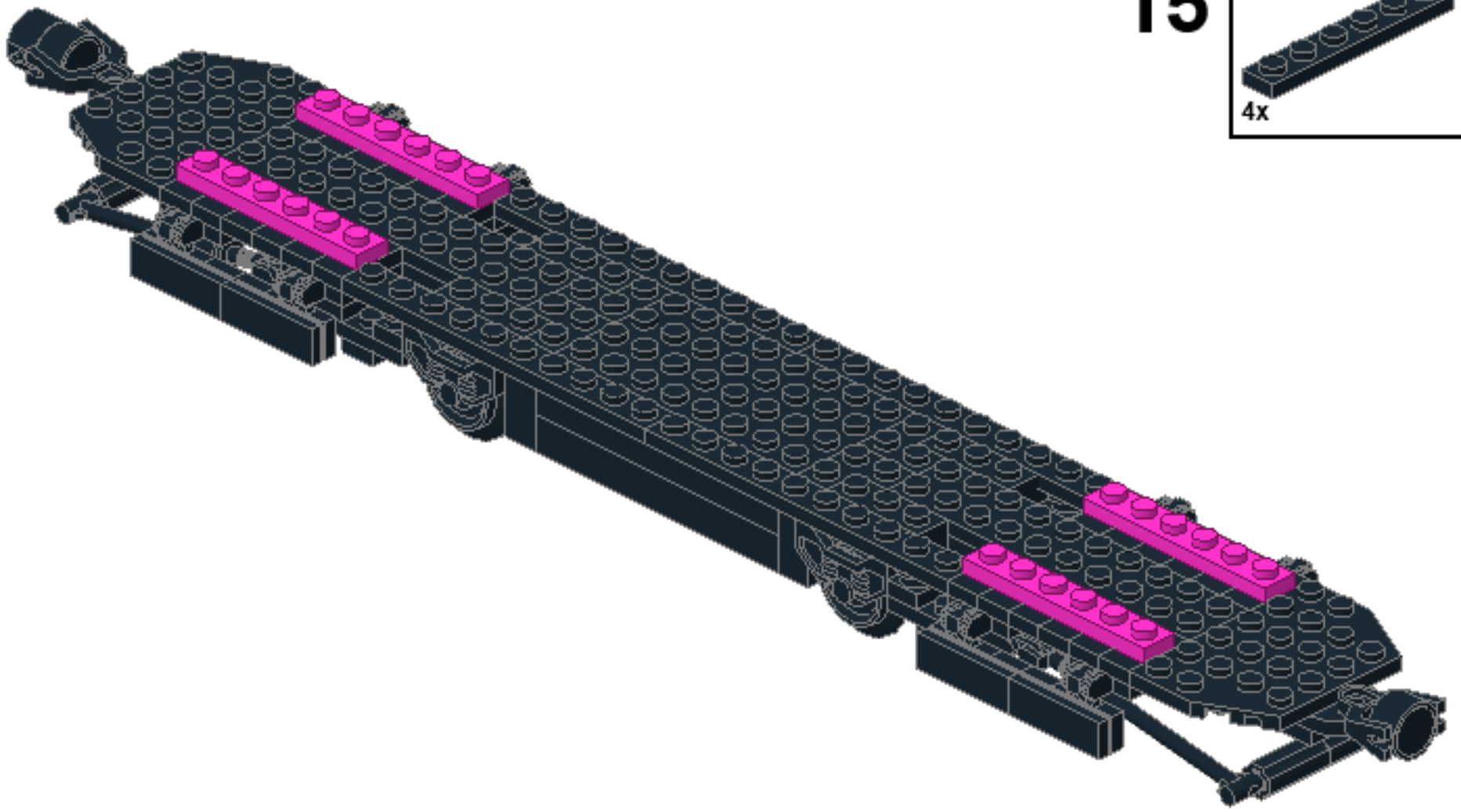
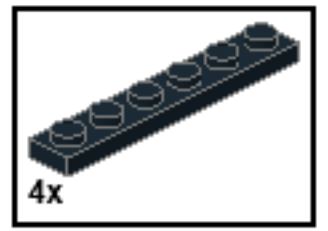

16

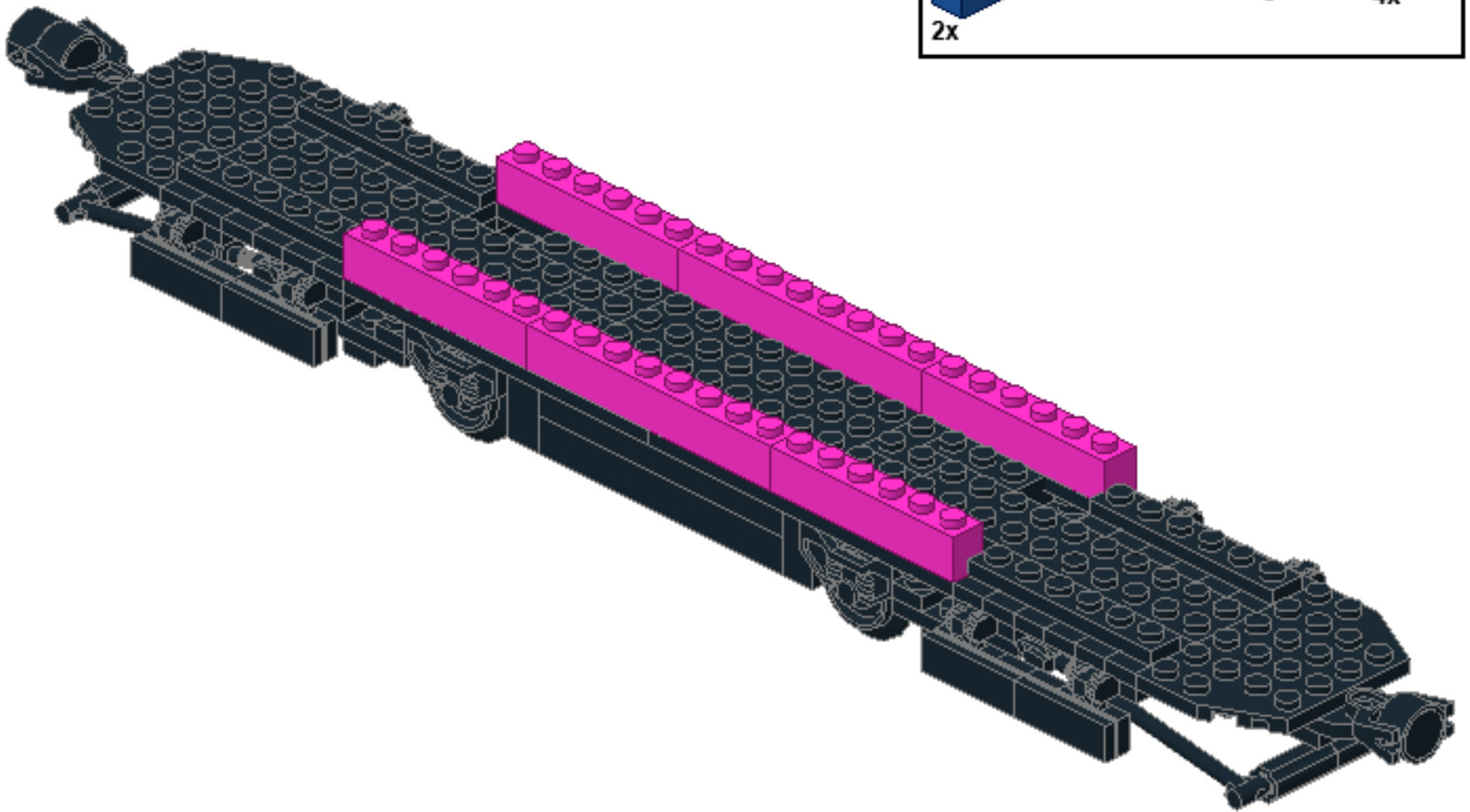
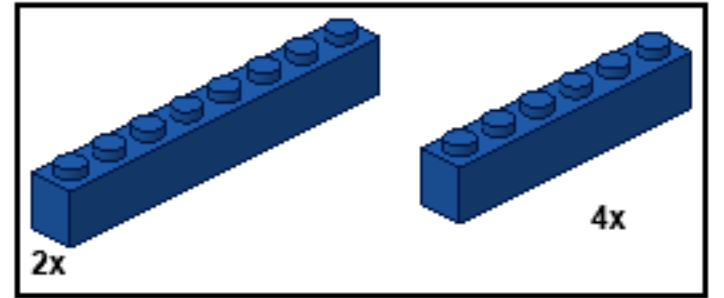

17

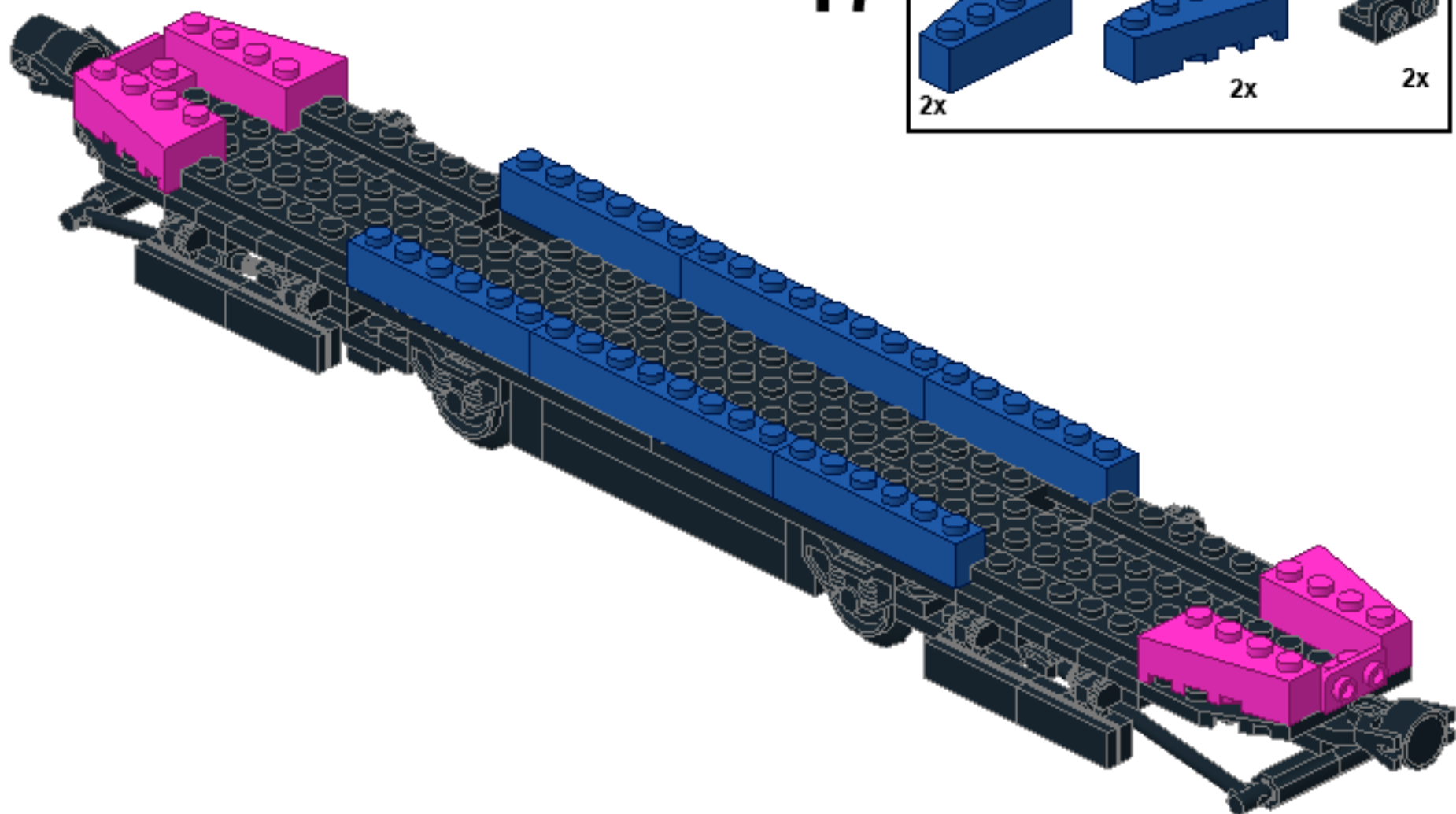
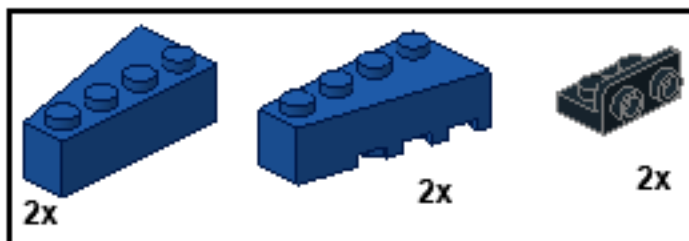

18

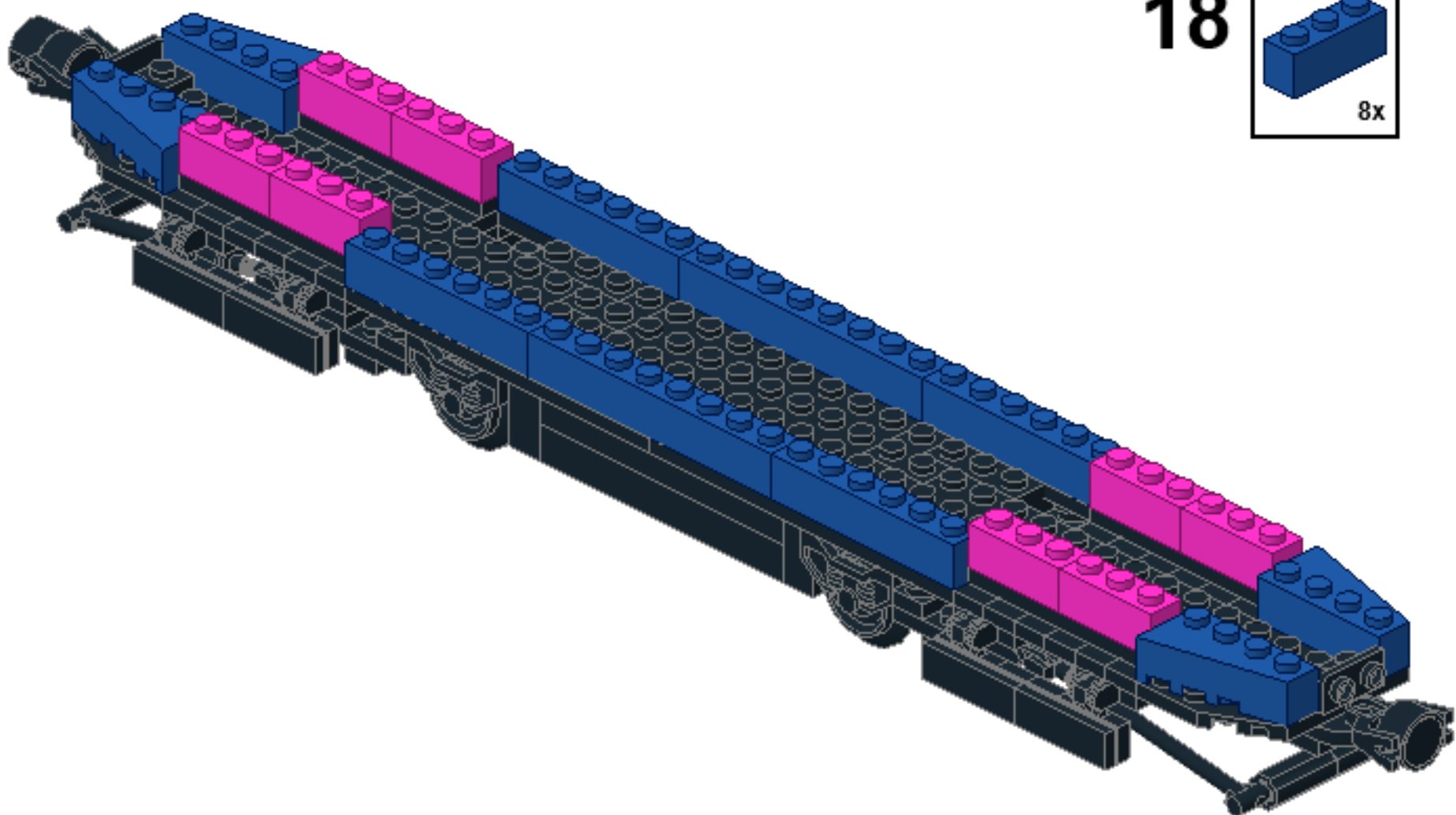
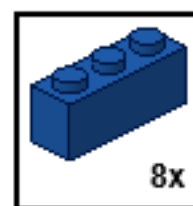

# 19

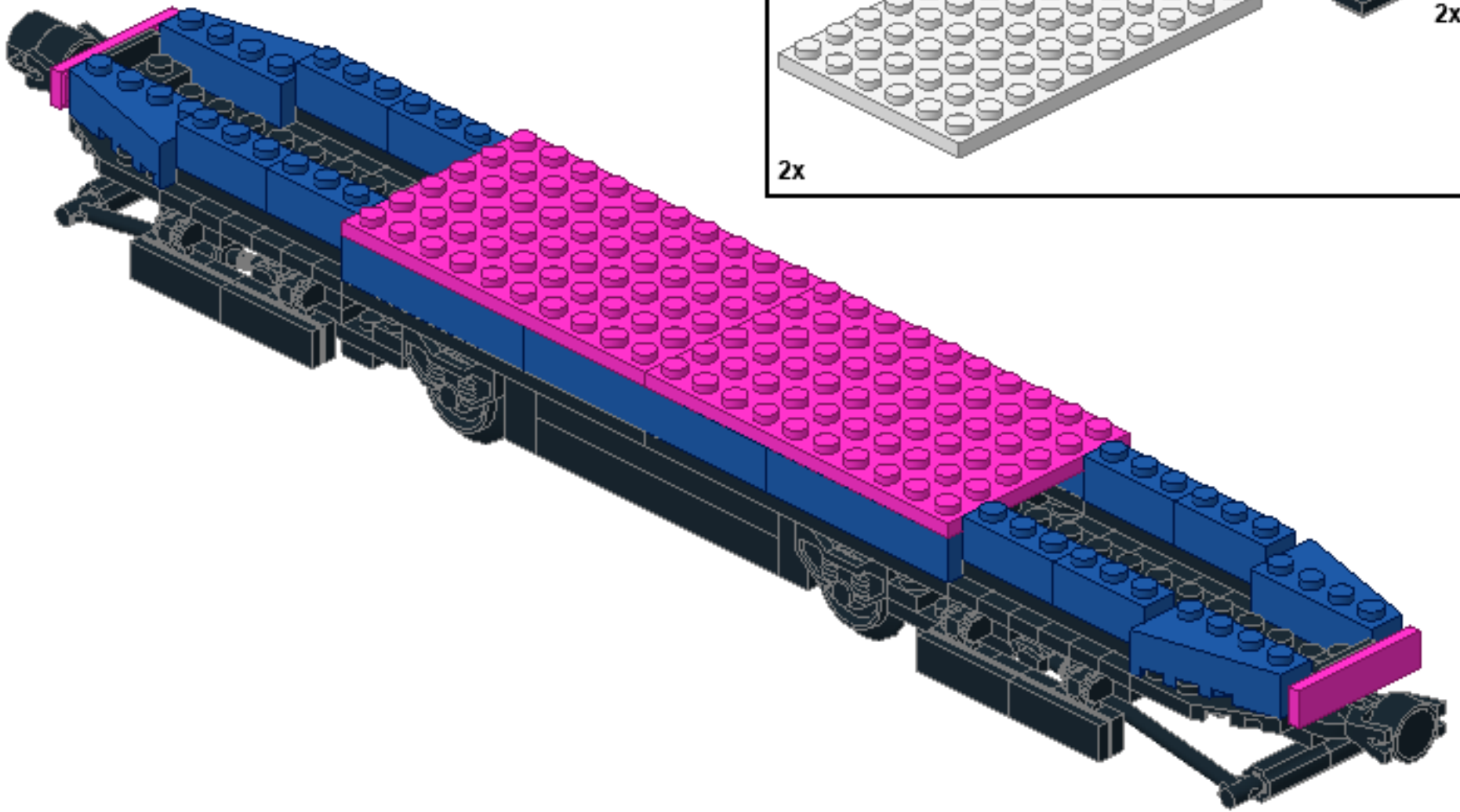
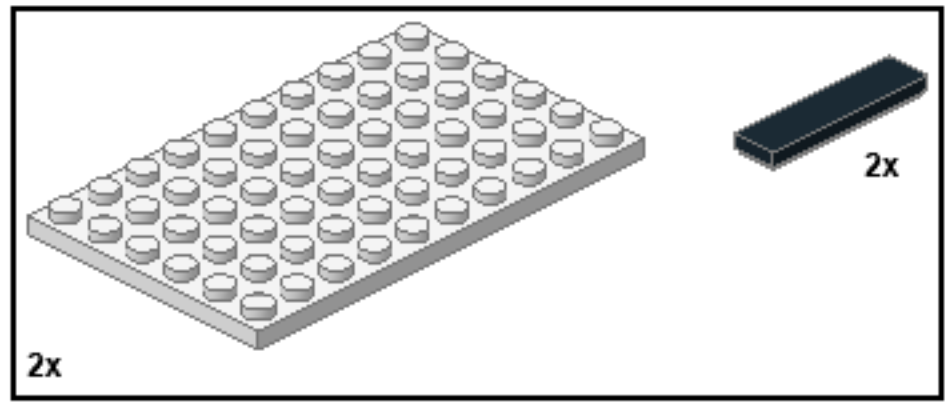

# 20

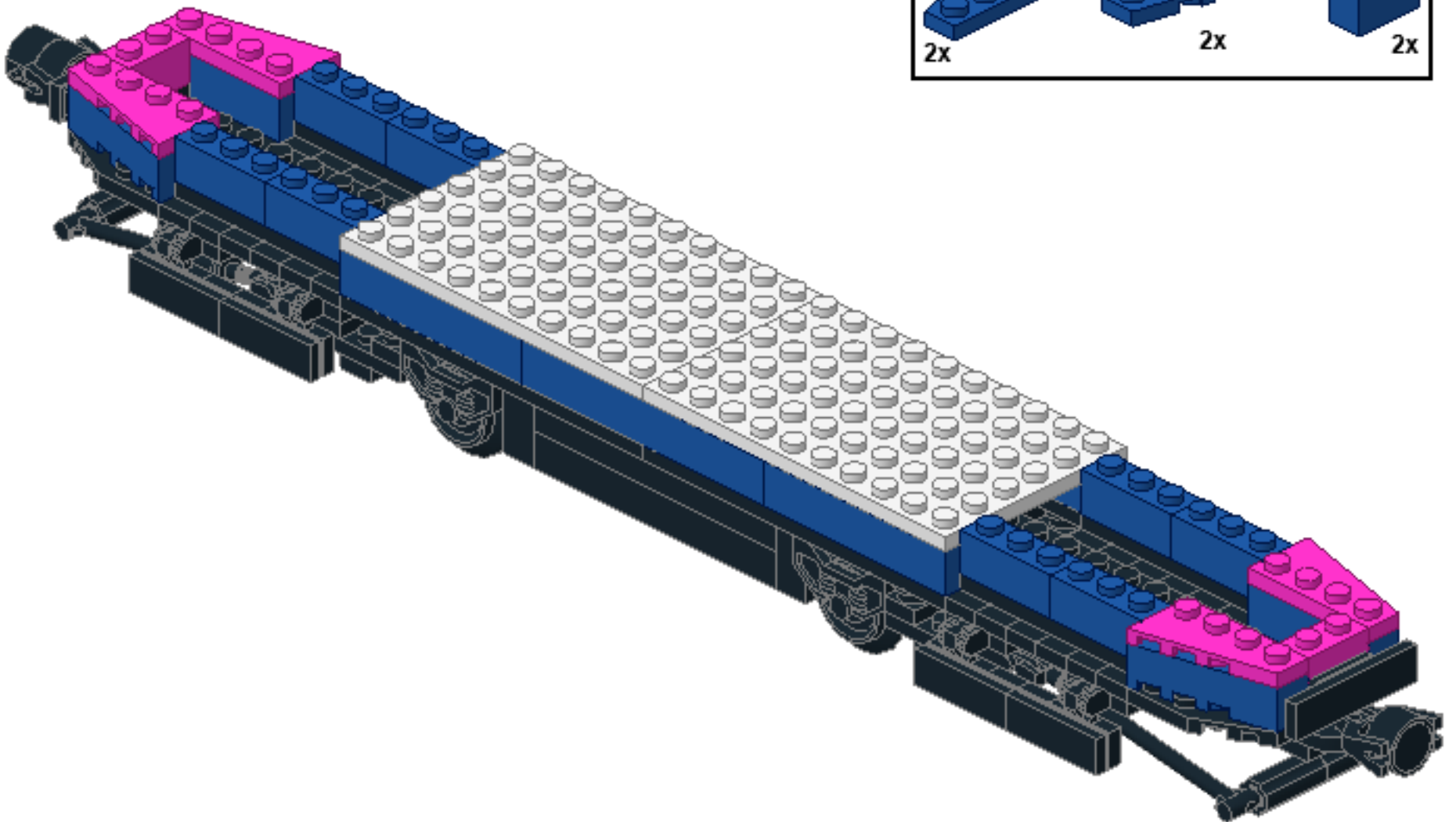
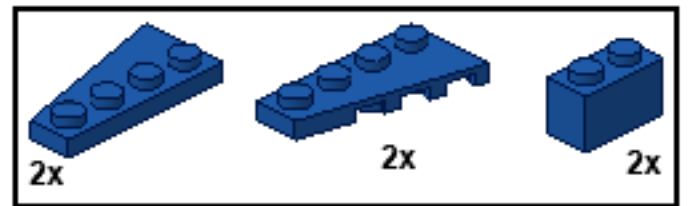



21

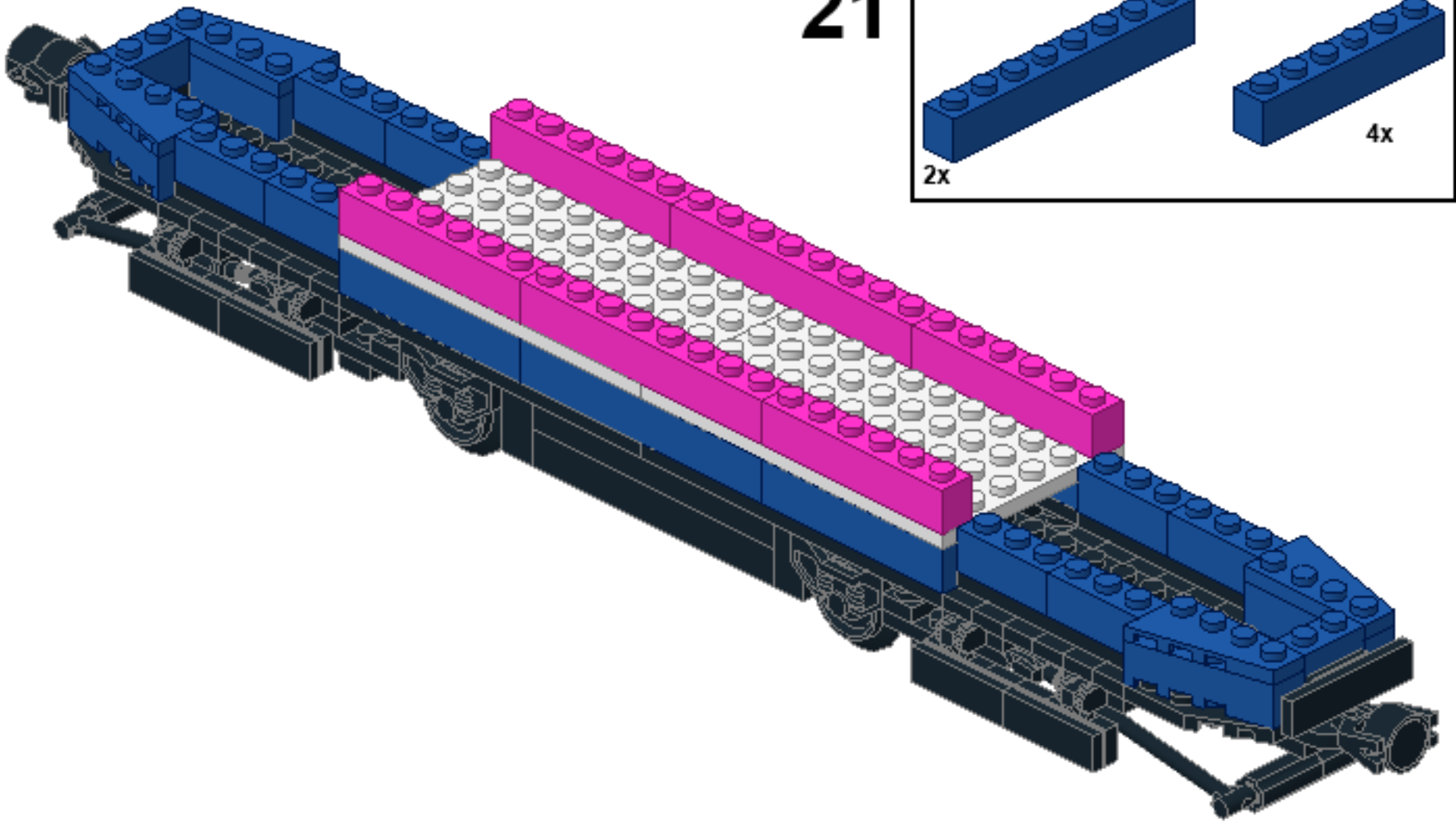
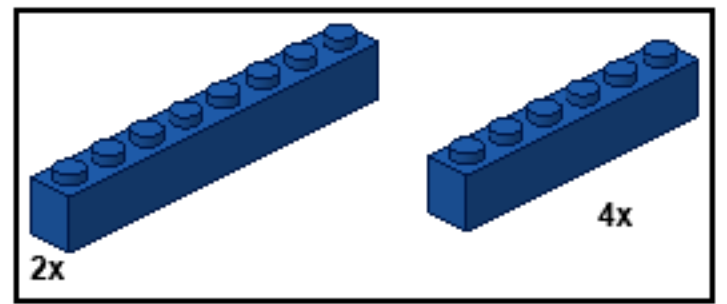

22

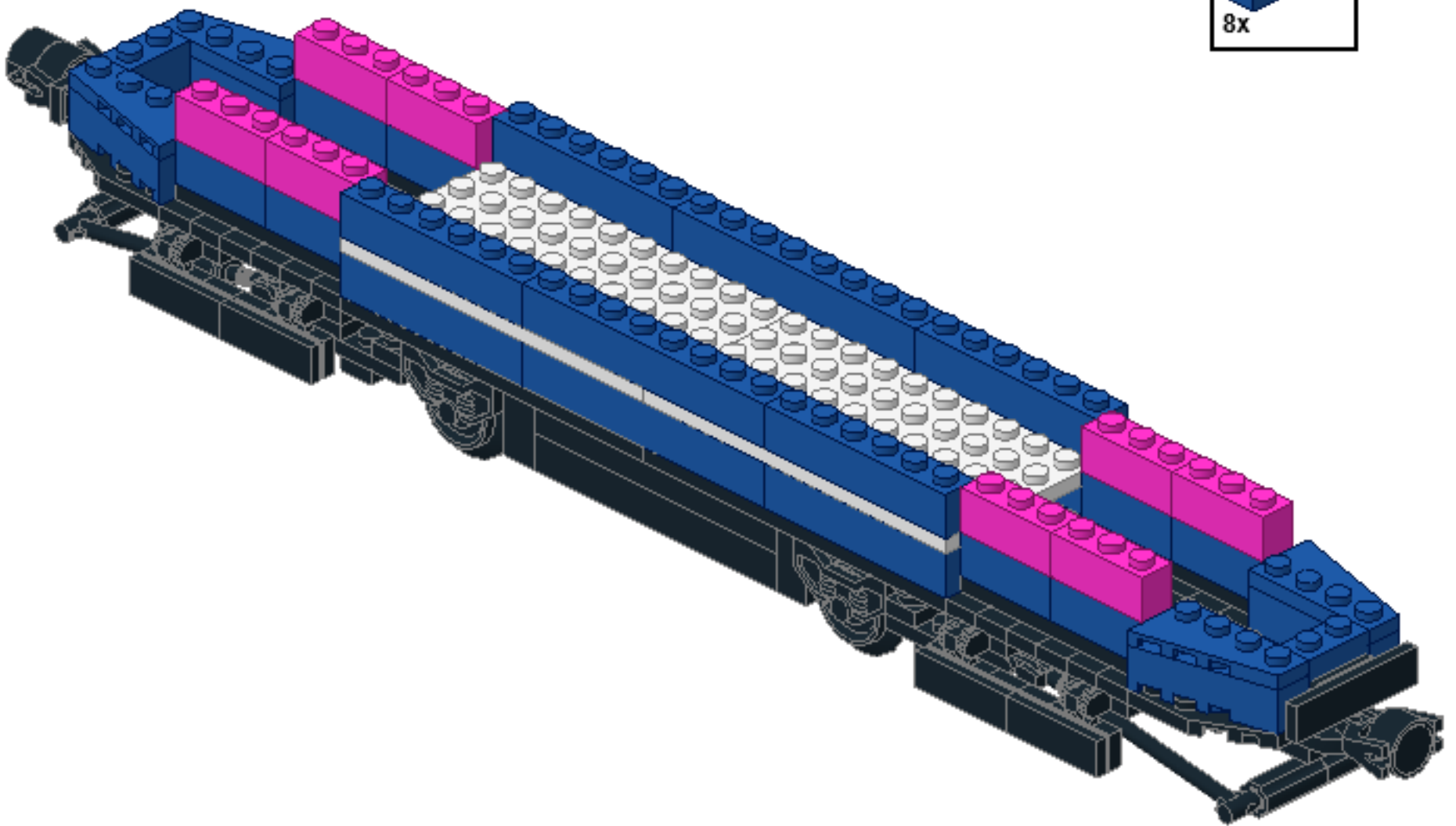
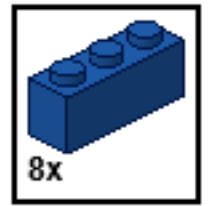

23

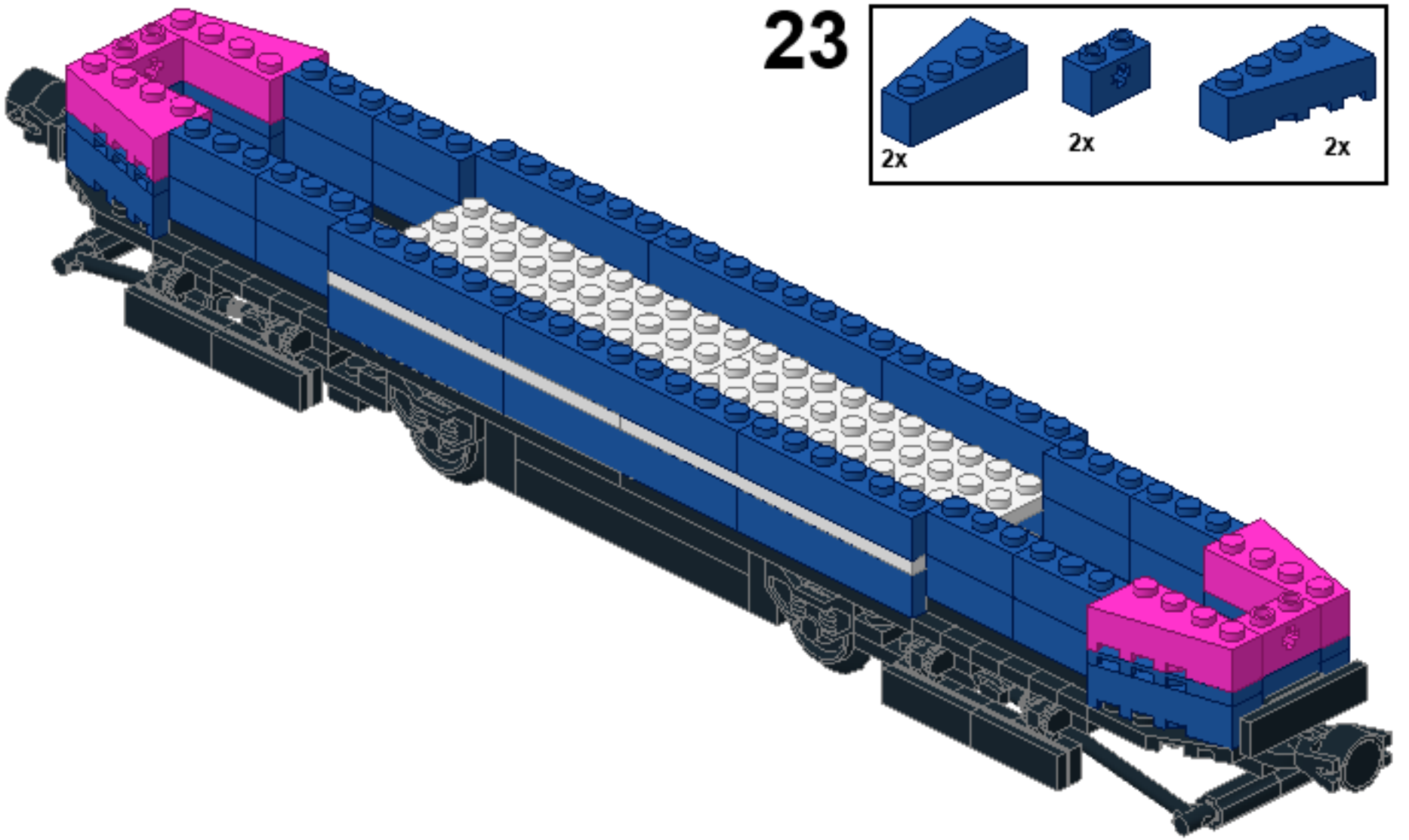
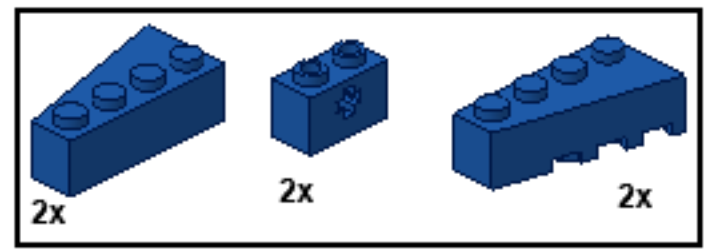

24

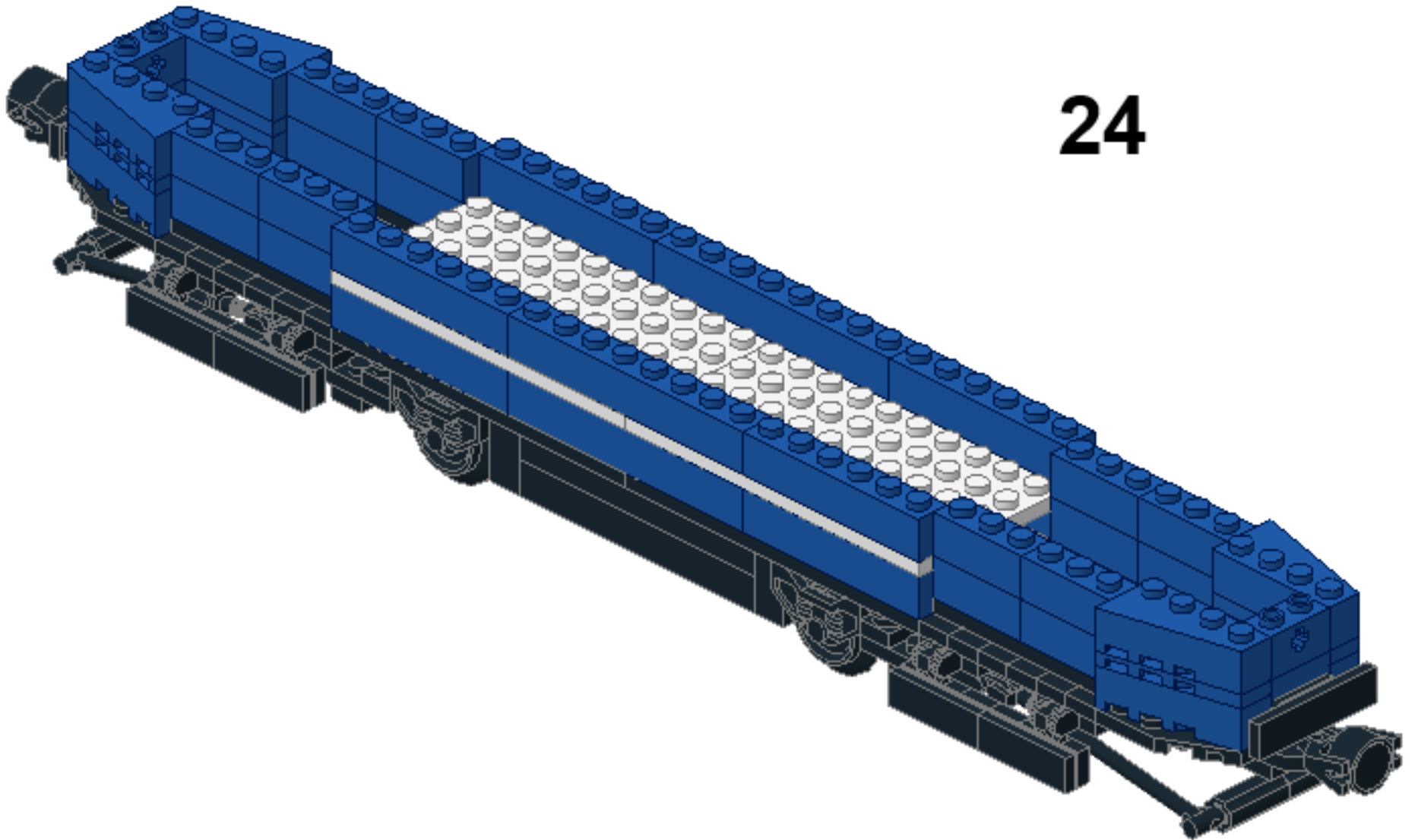



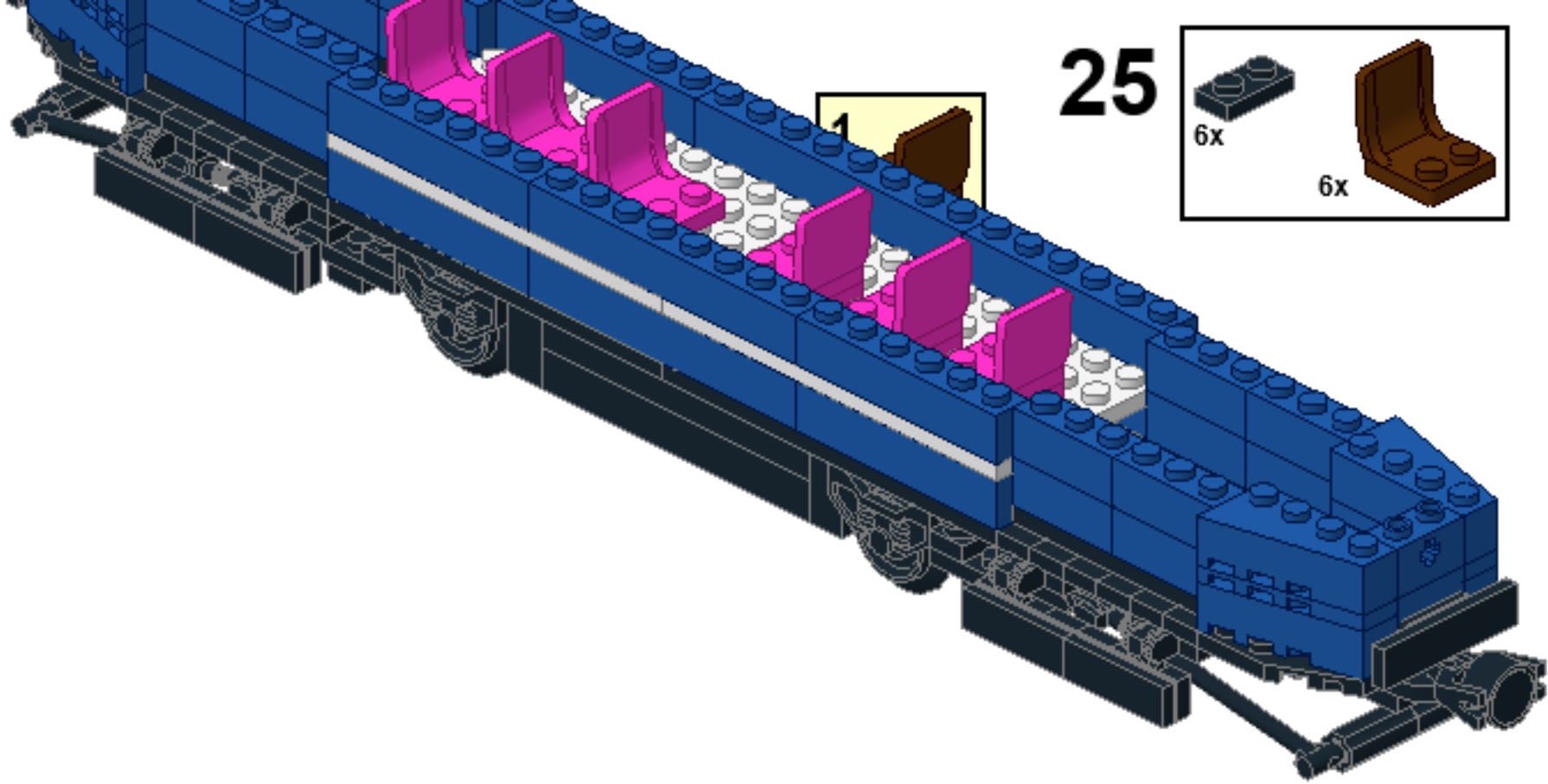

25

6x	6x

26

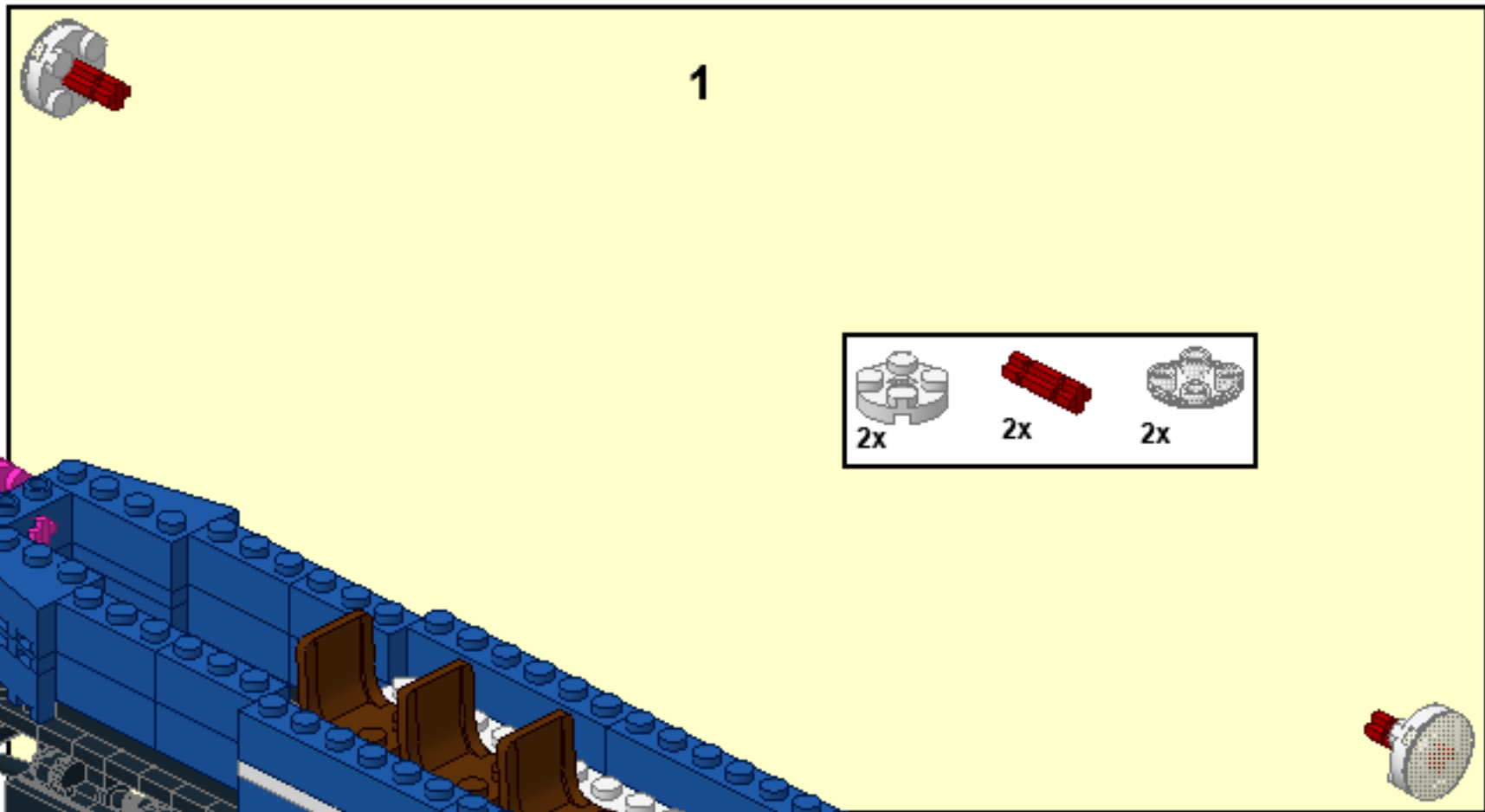

1

2x	2x	2x

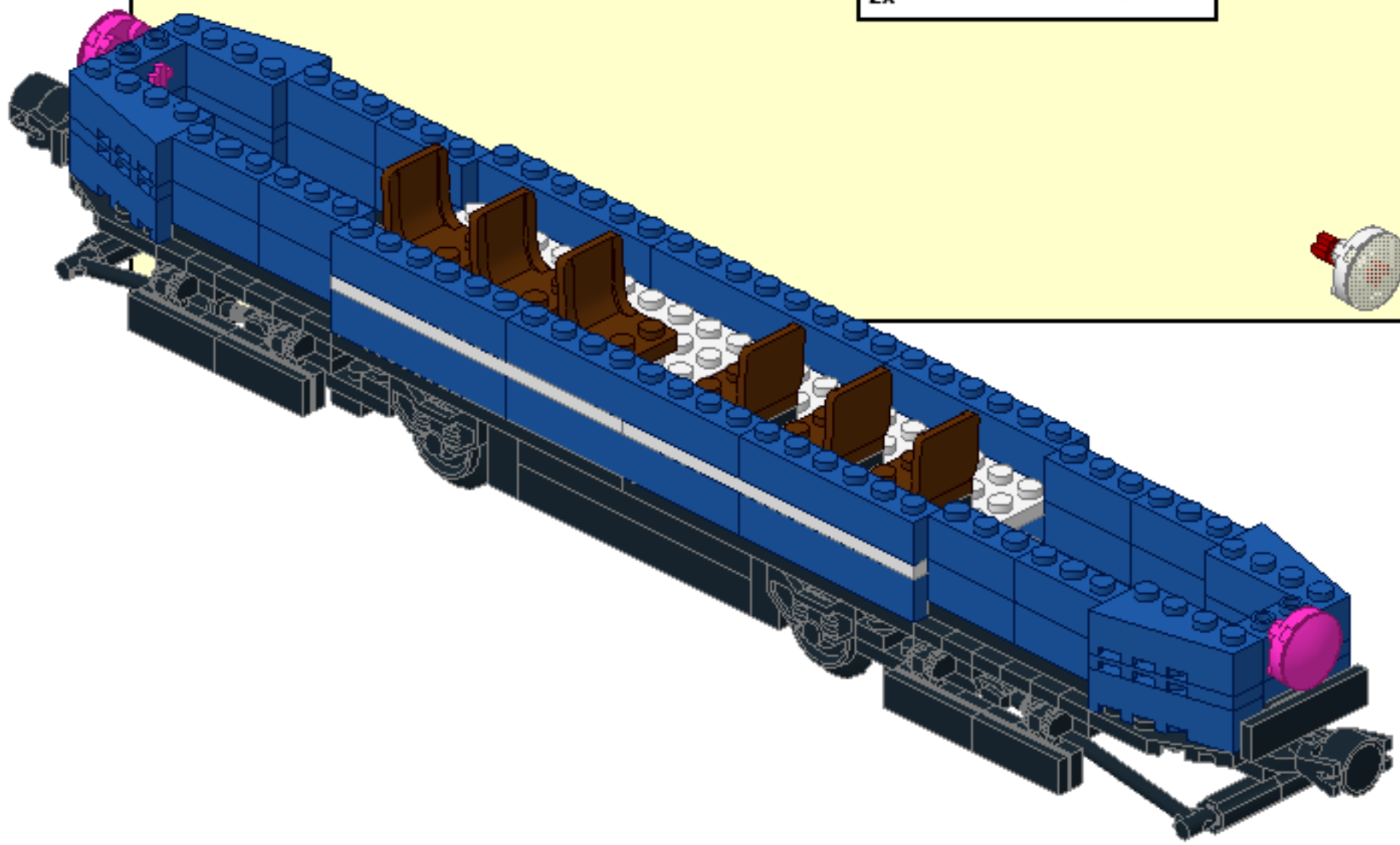

27

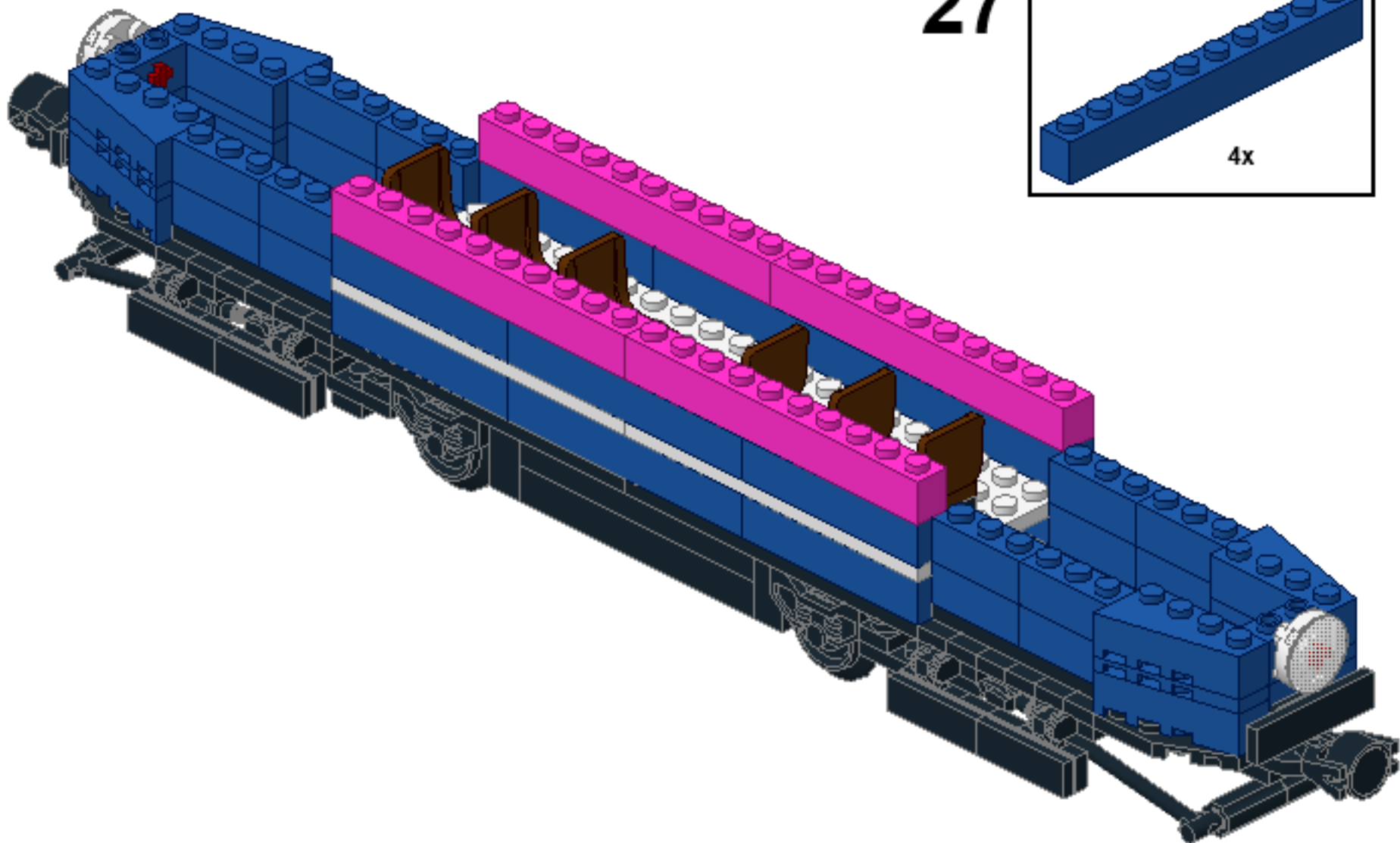
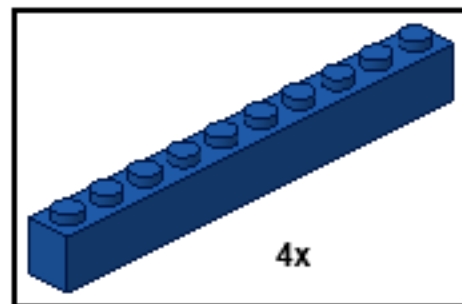

28

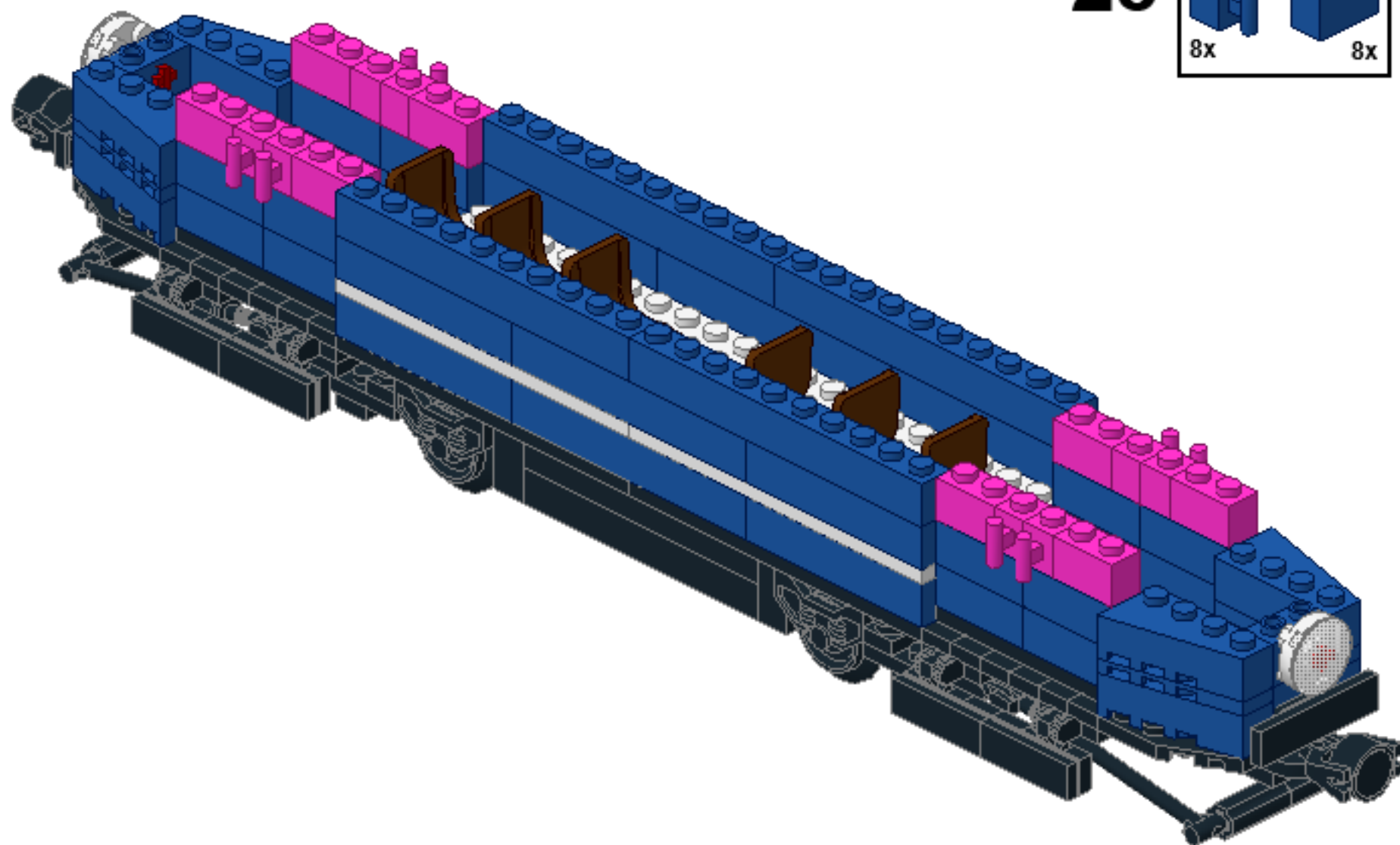
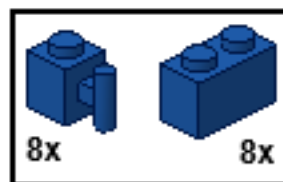

29

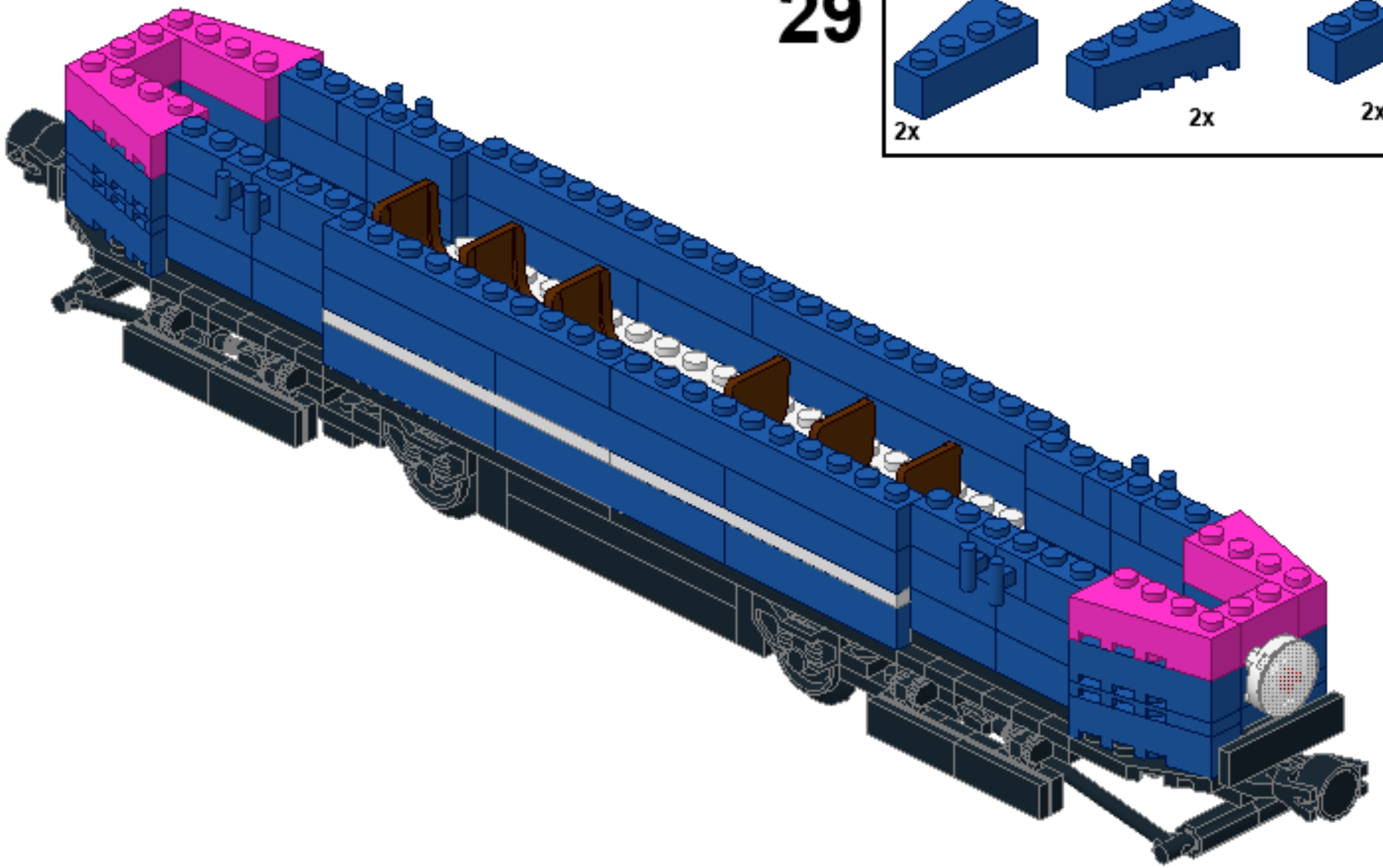
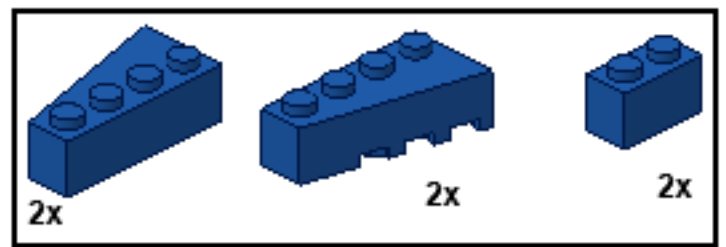

30

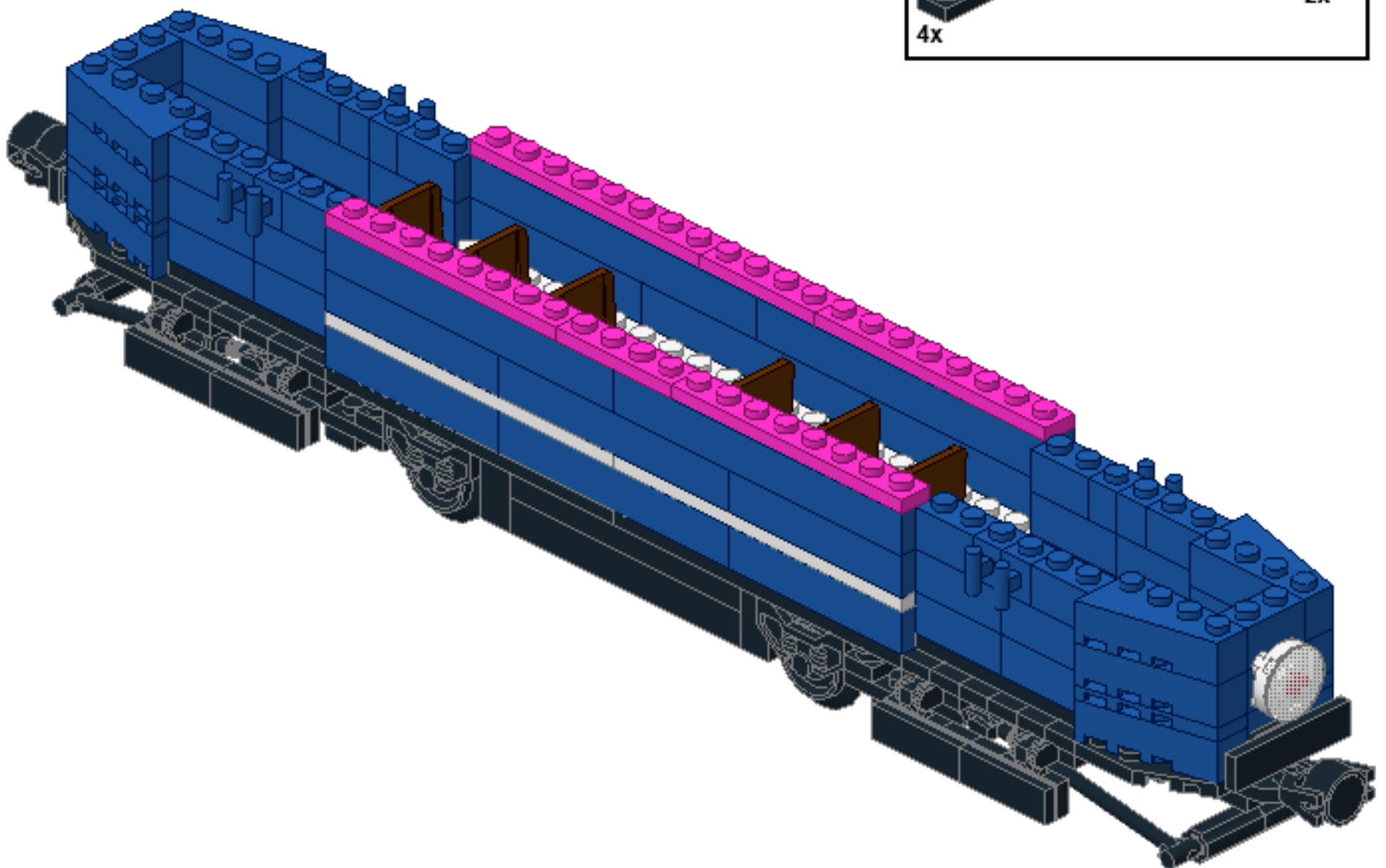
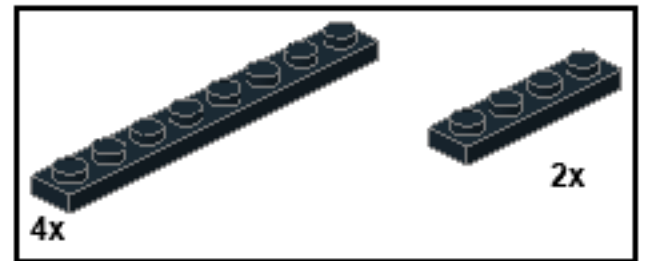



31

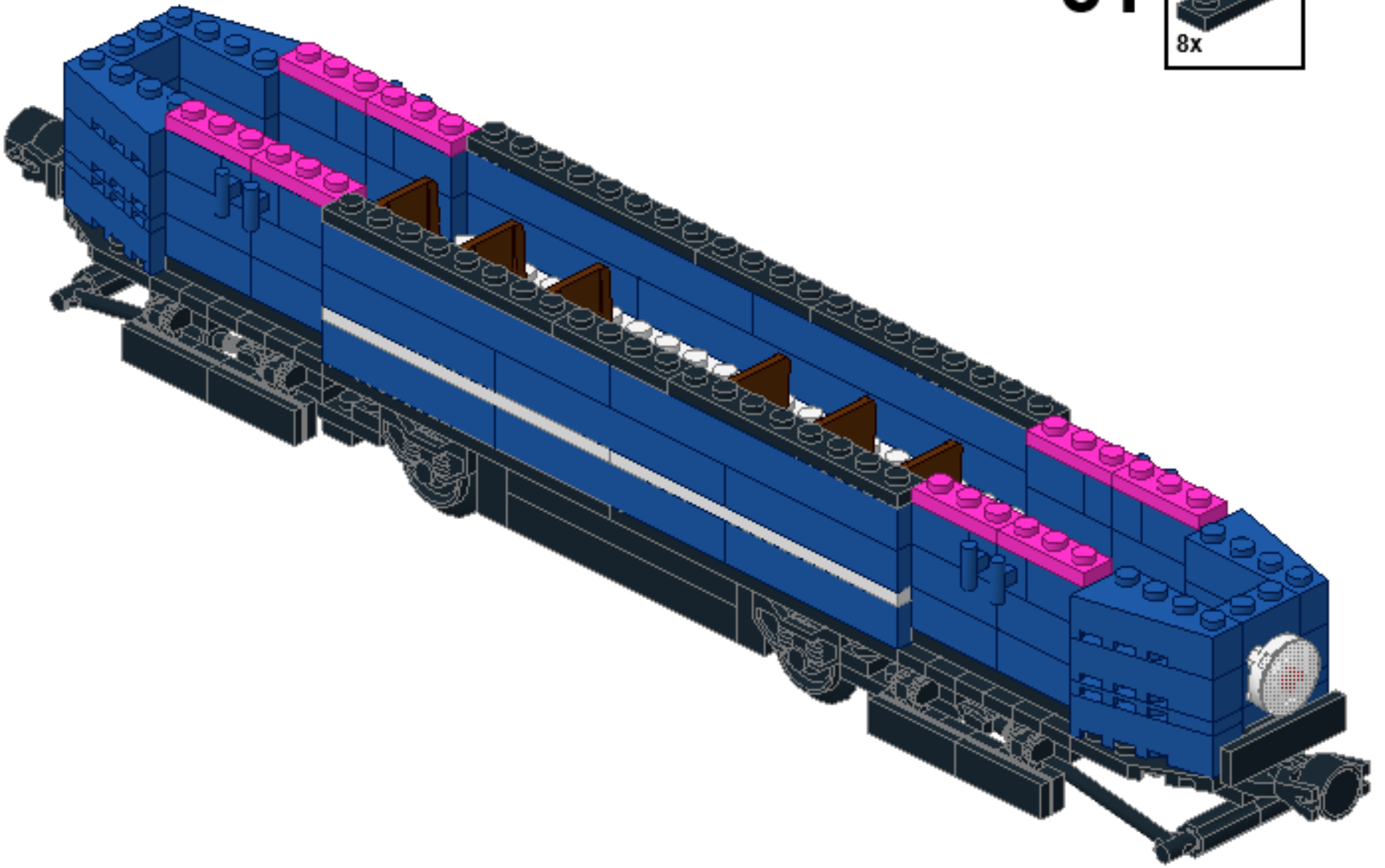
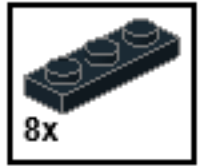

32

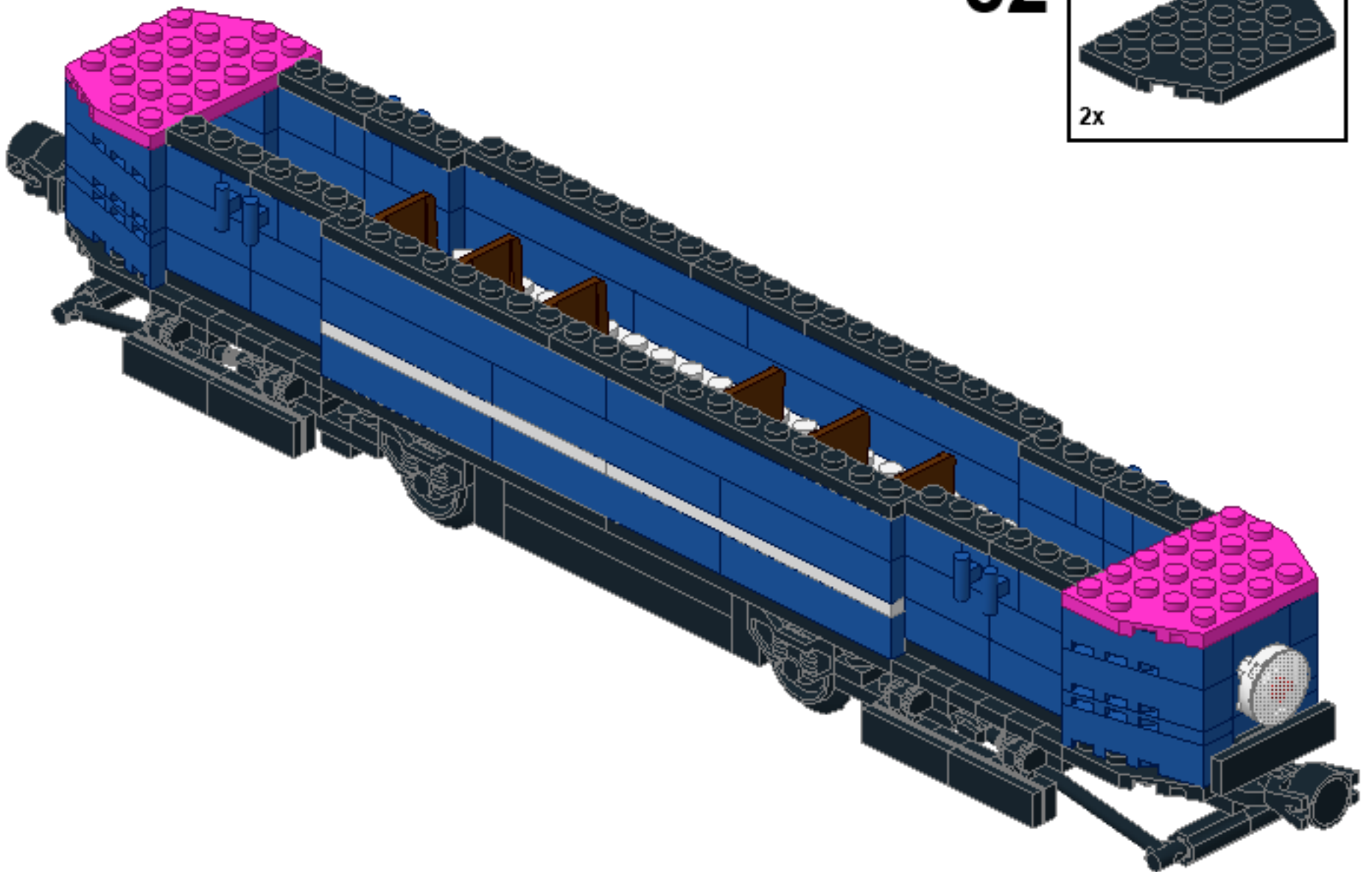
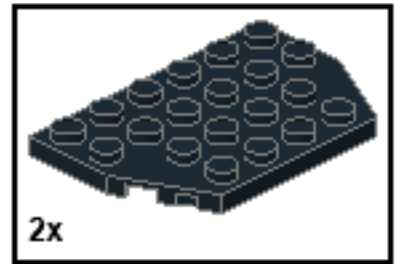

# 33

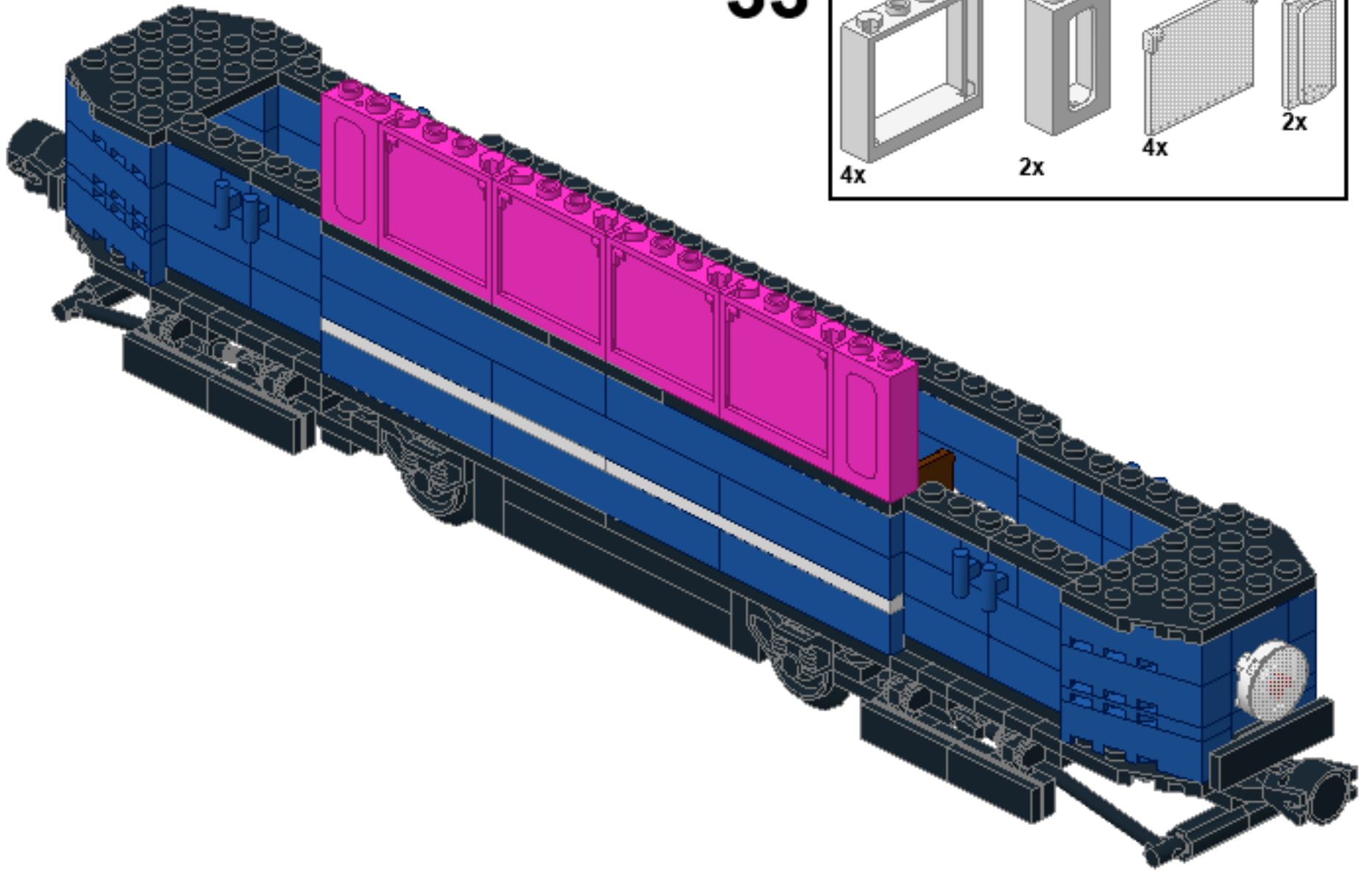
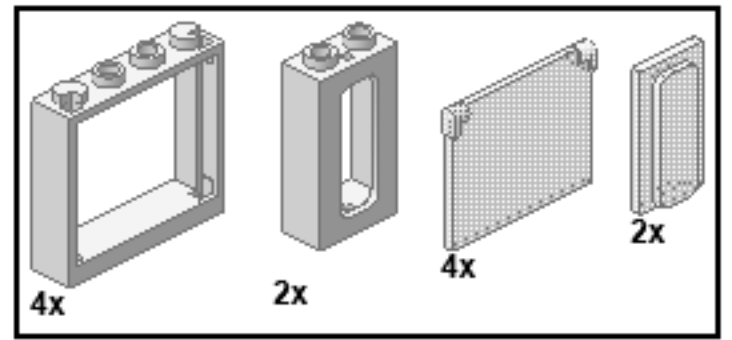

# 34

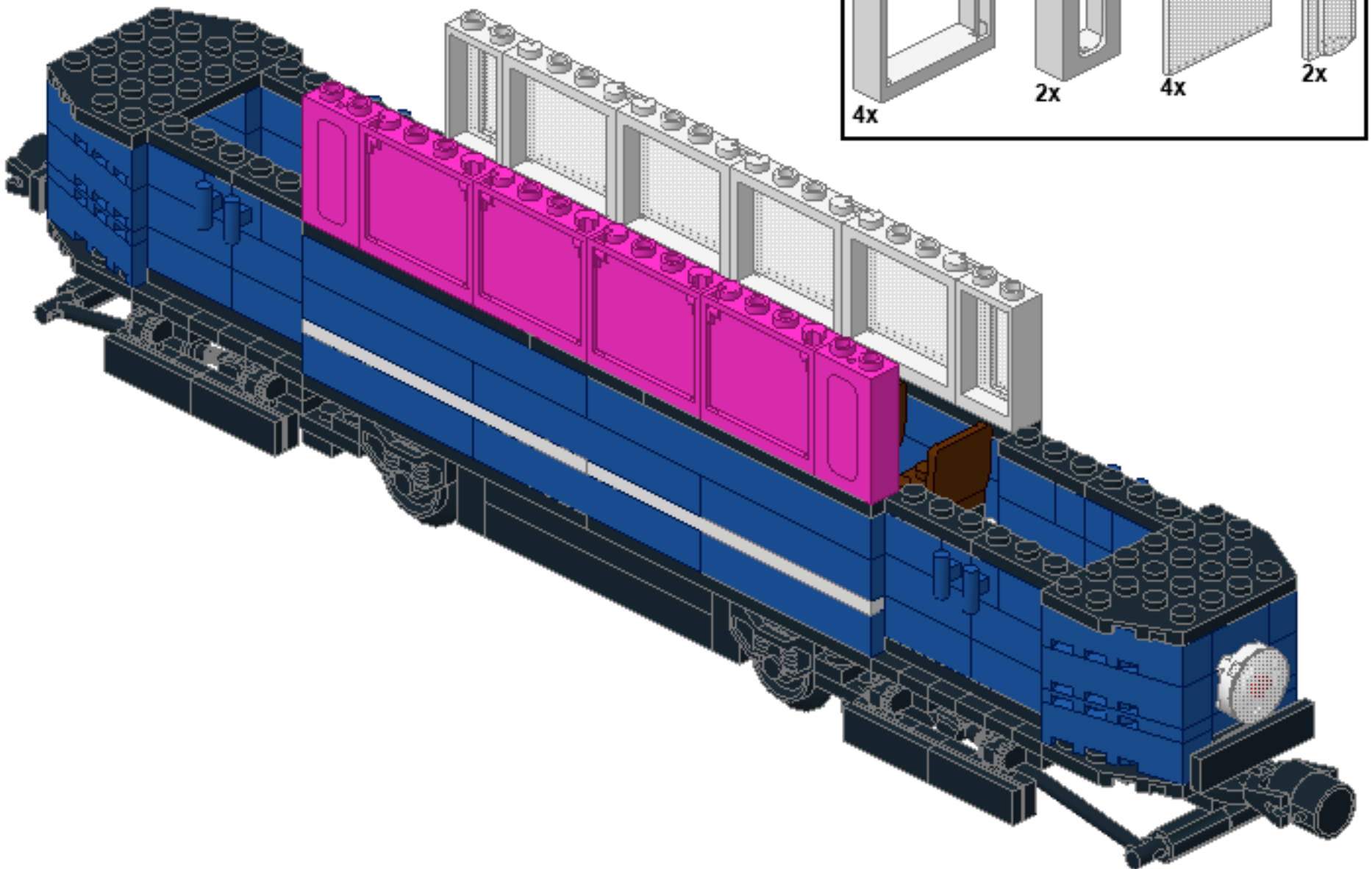
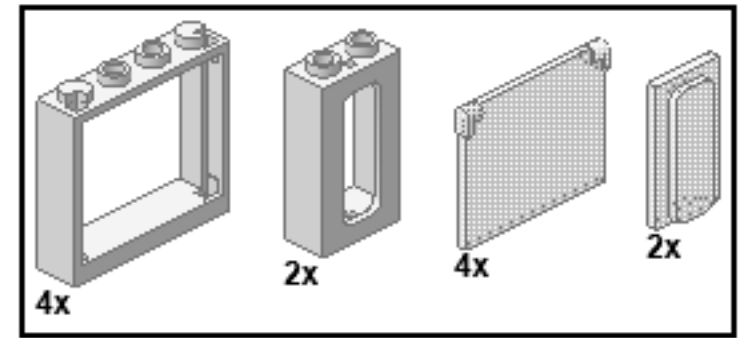



35

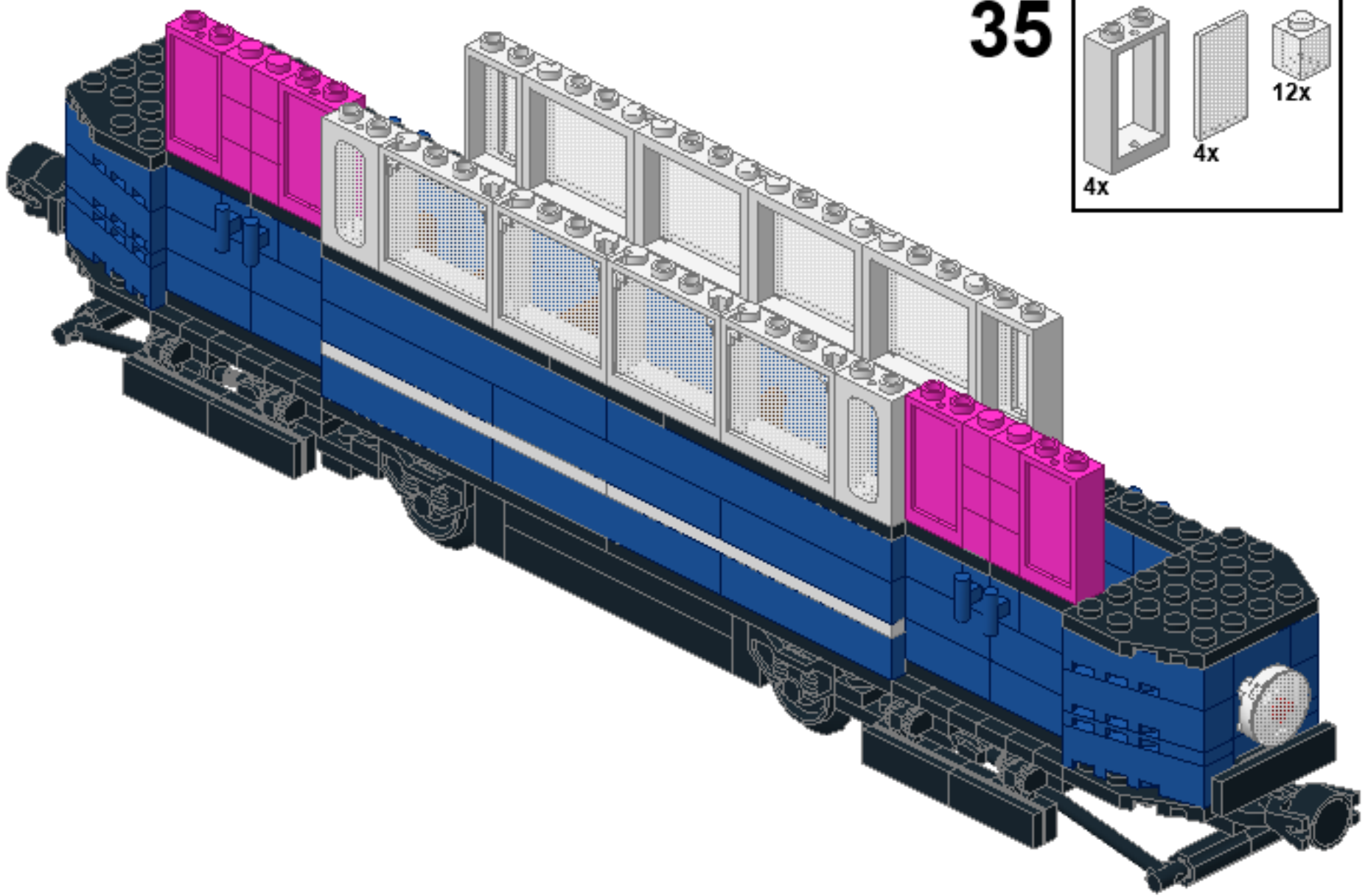
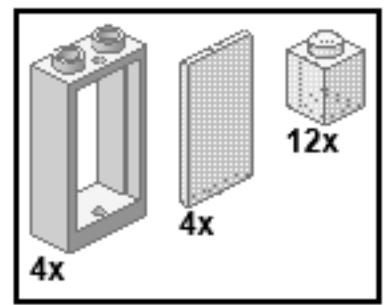

36

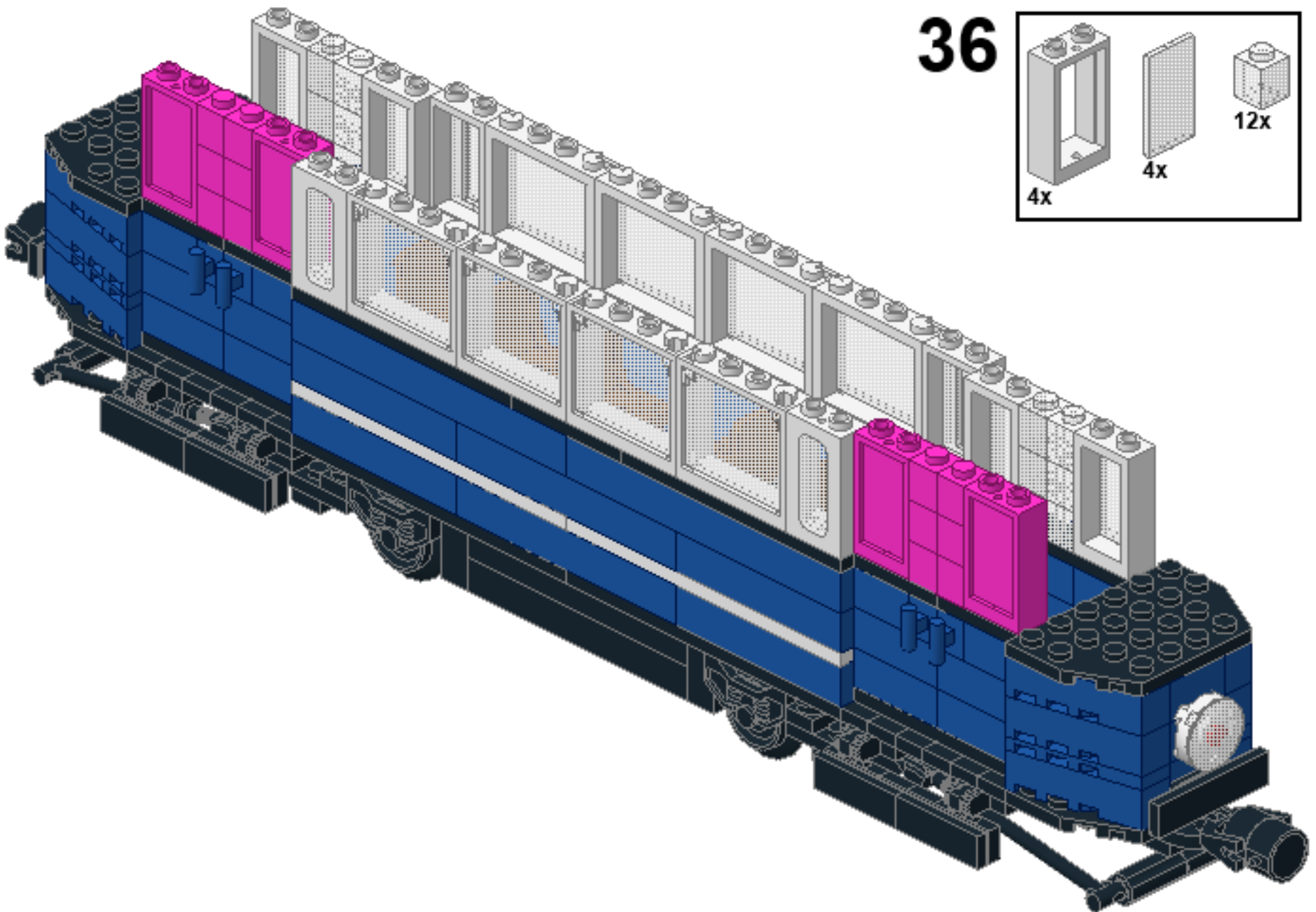
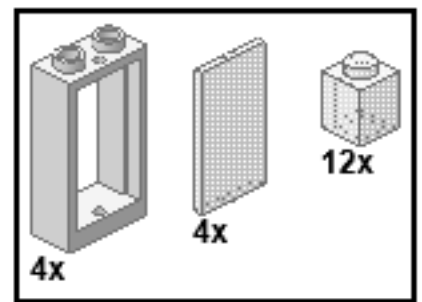

37

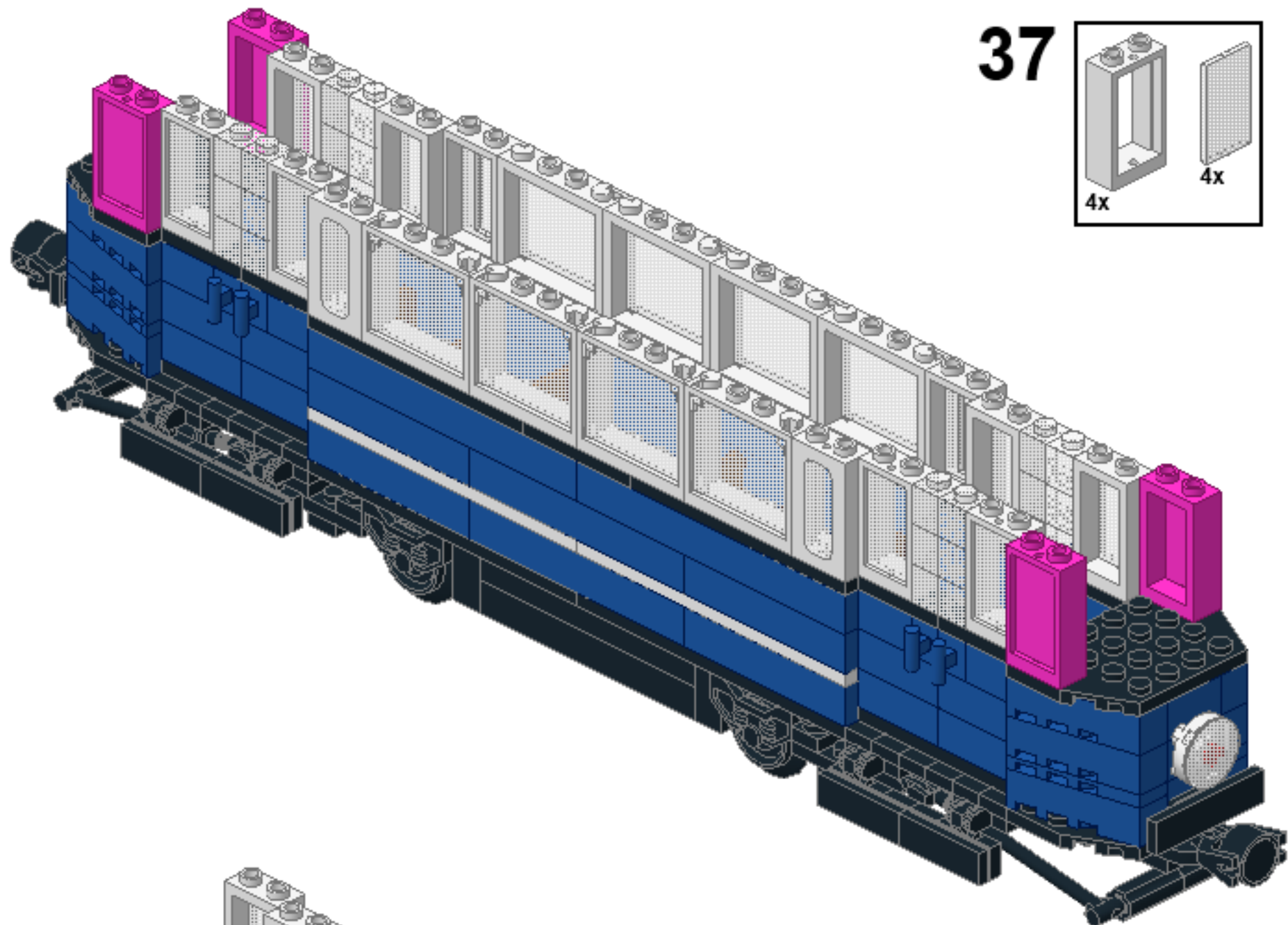
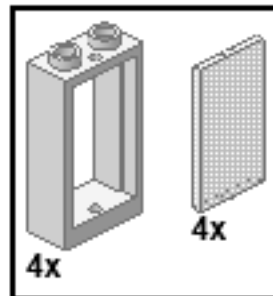

38

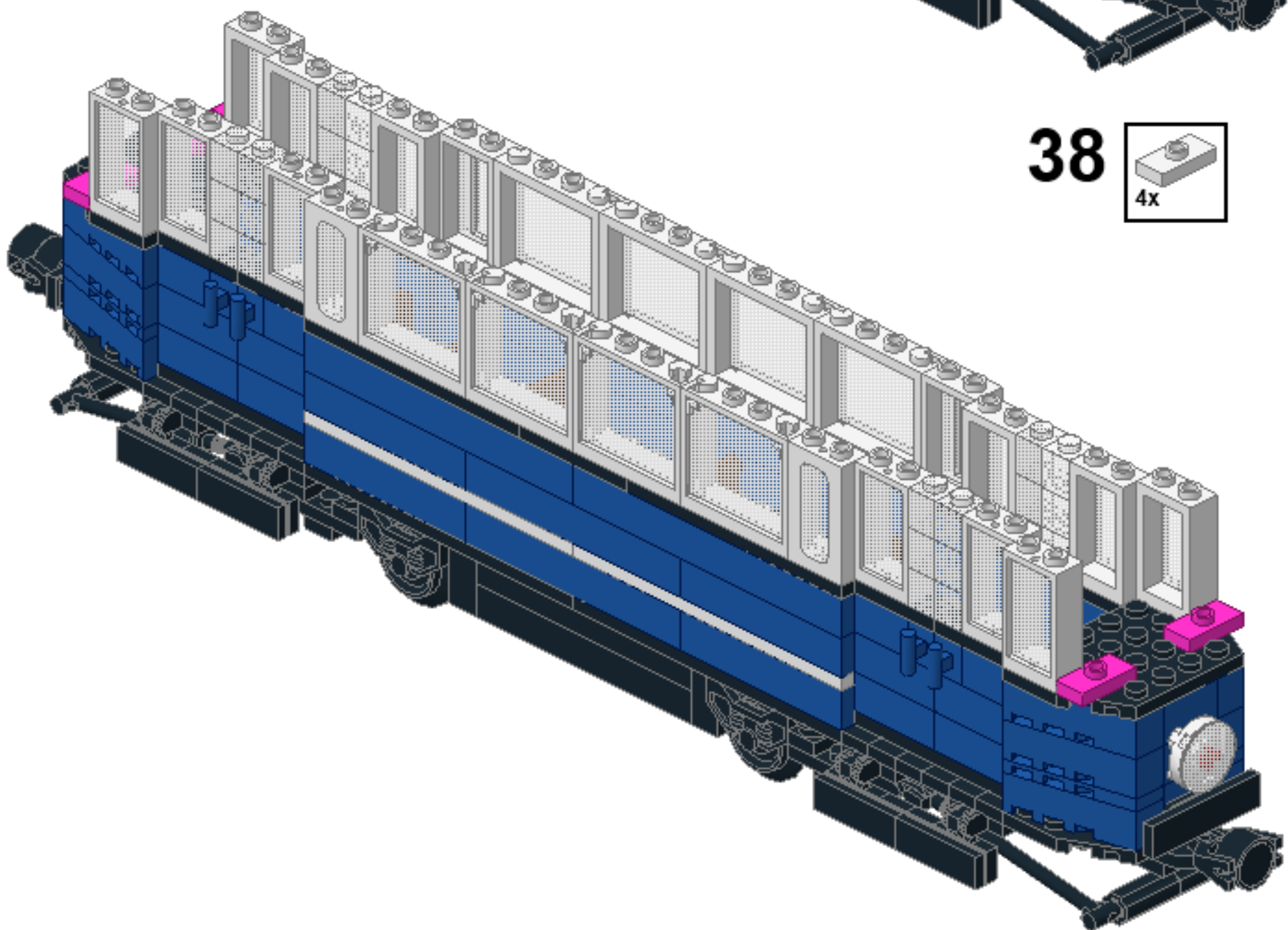
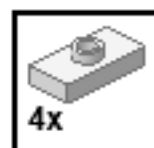

39

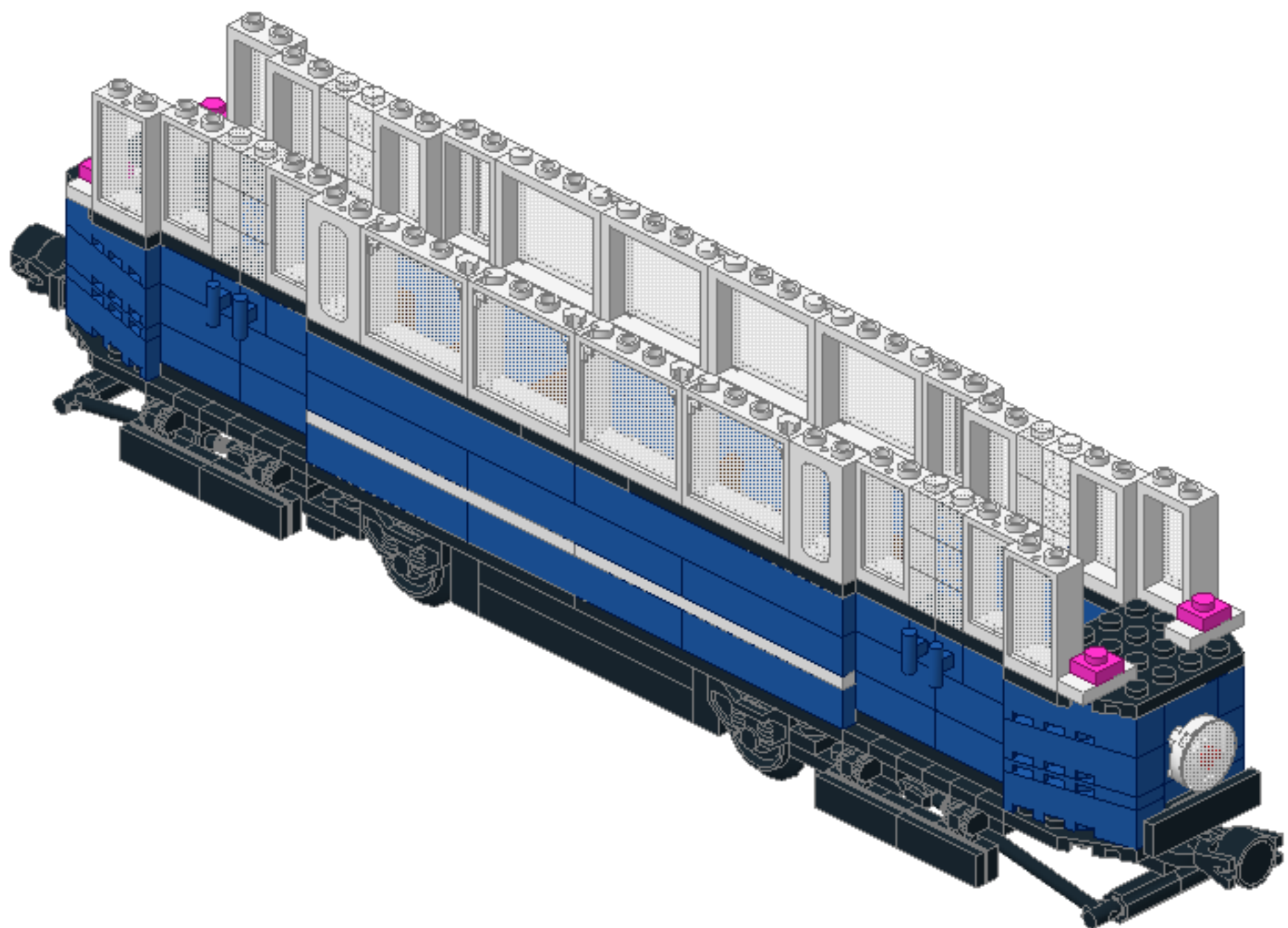



40

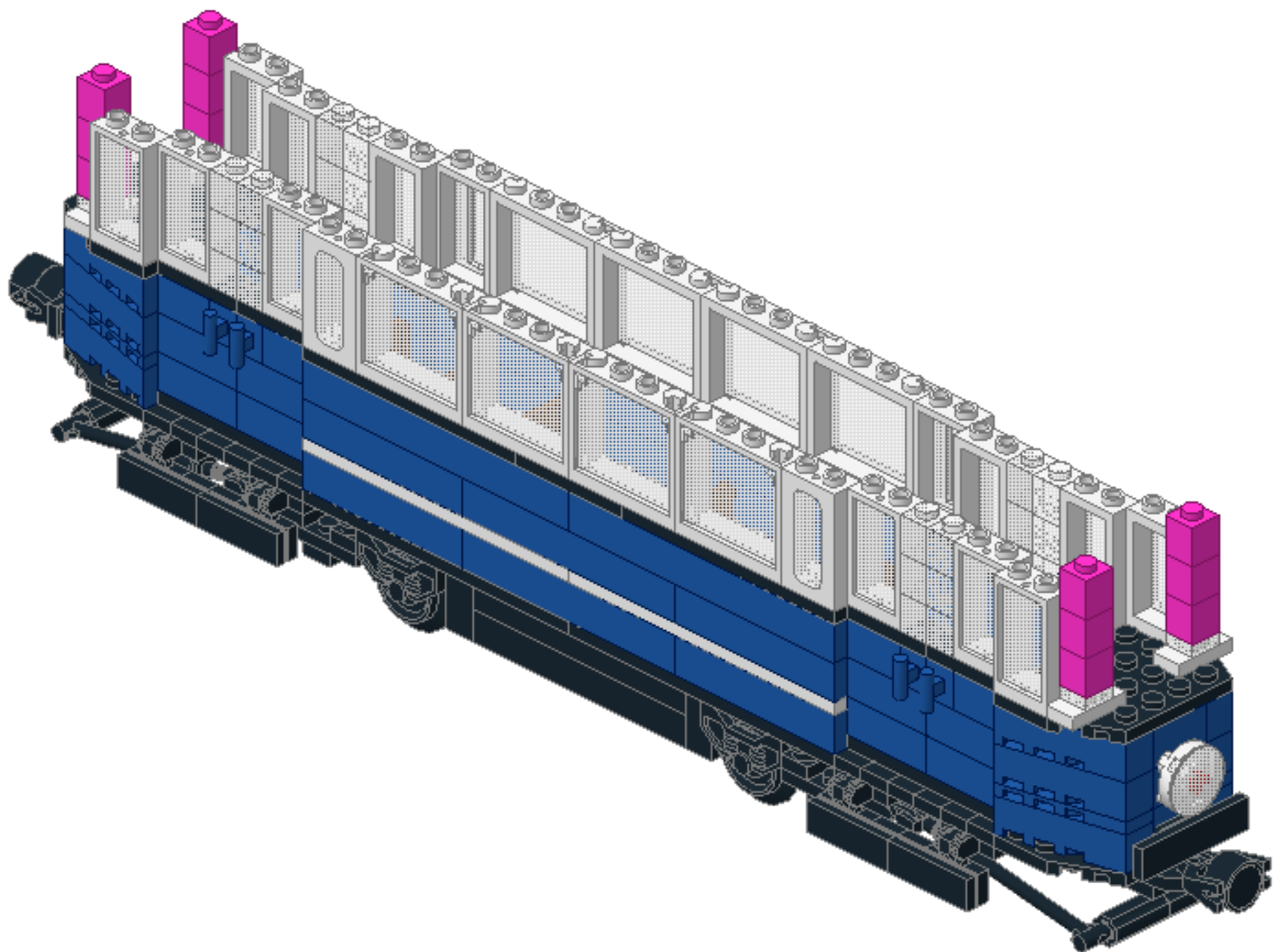

41

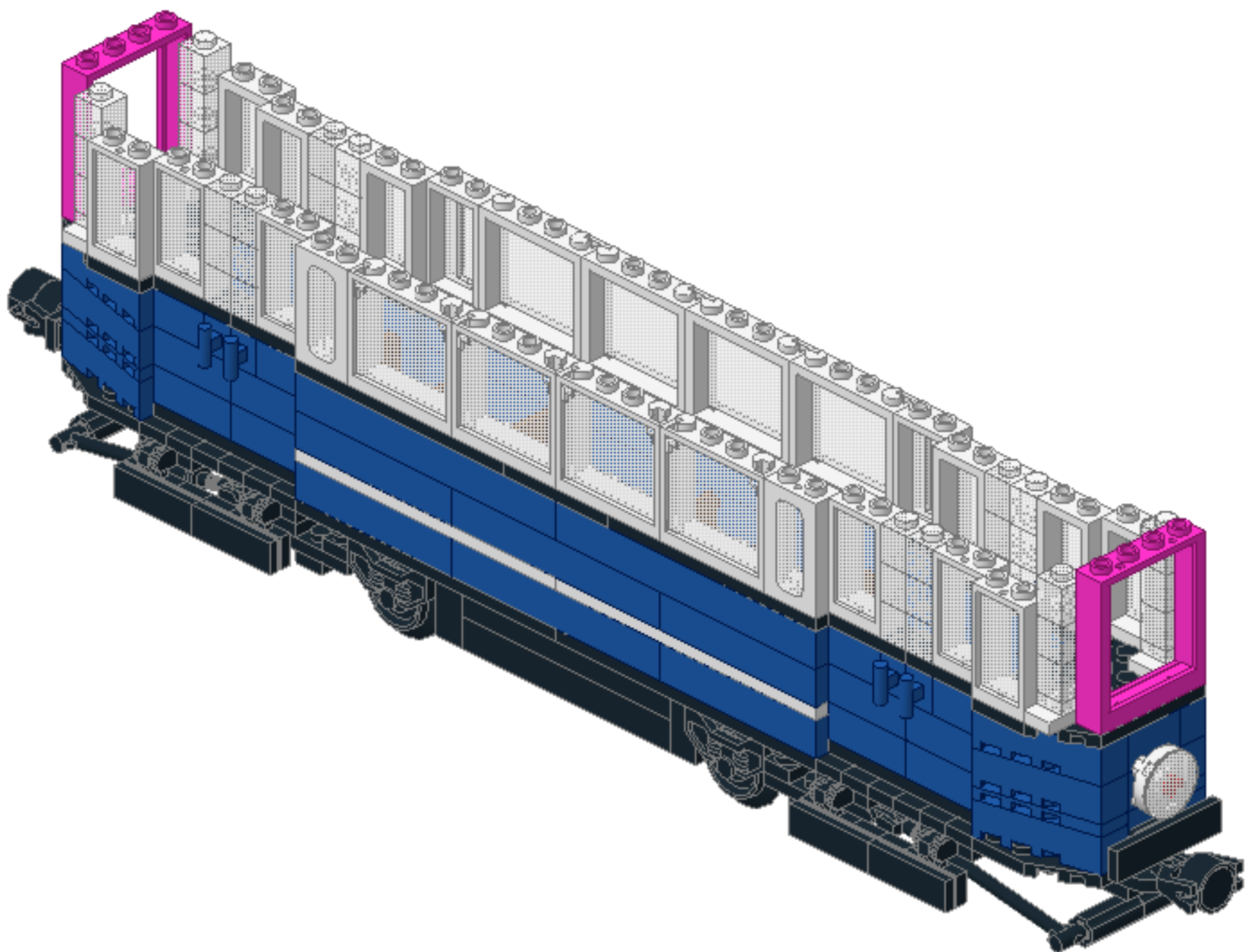
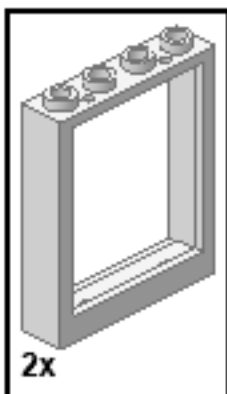



42

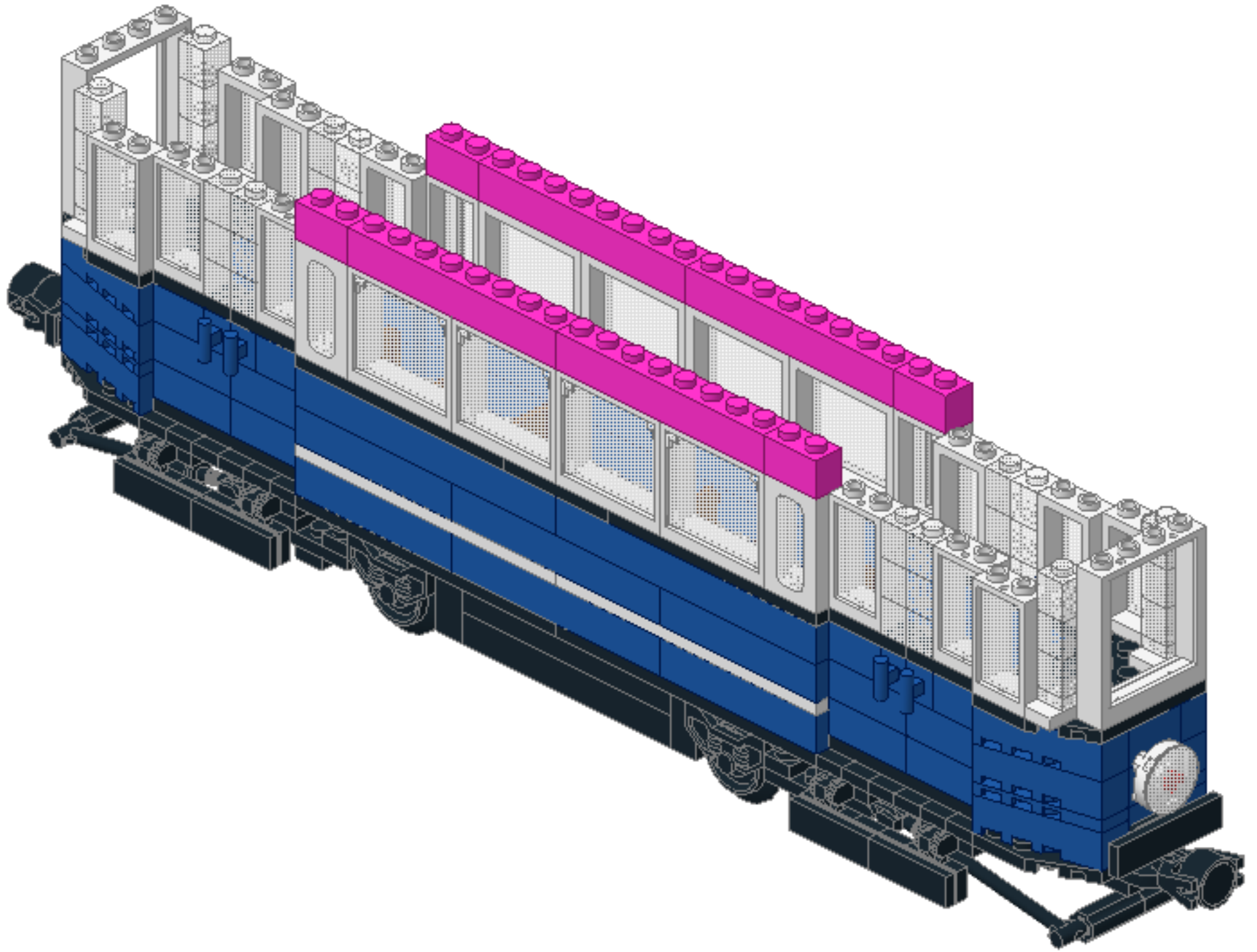
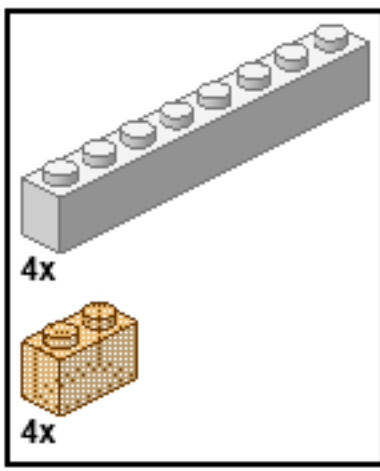

43

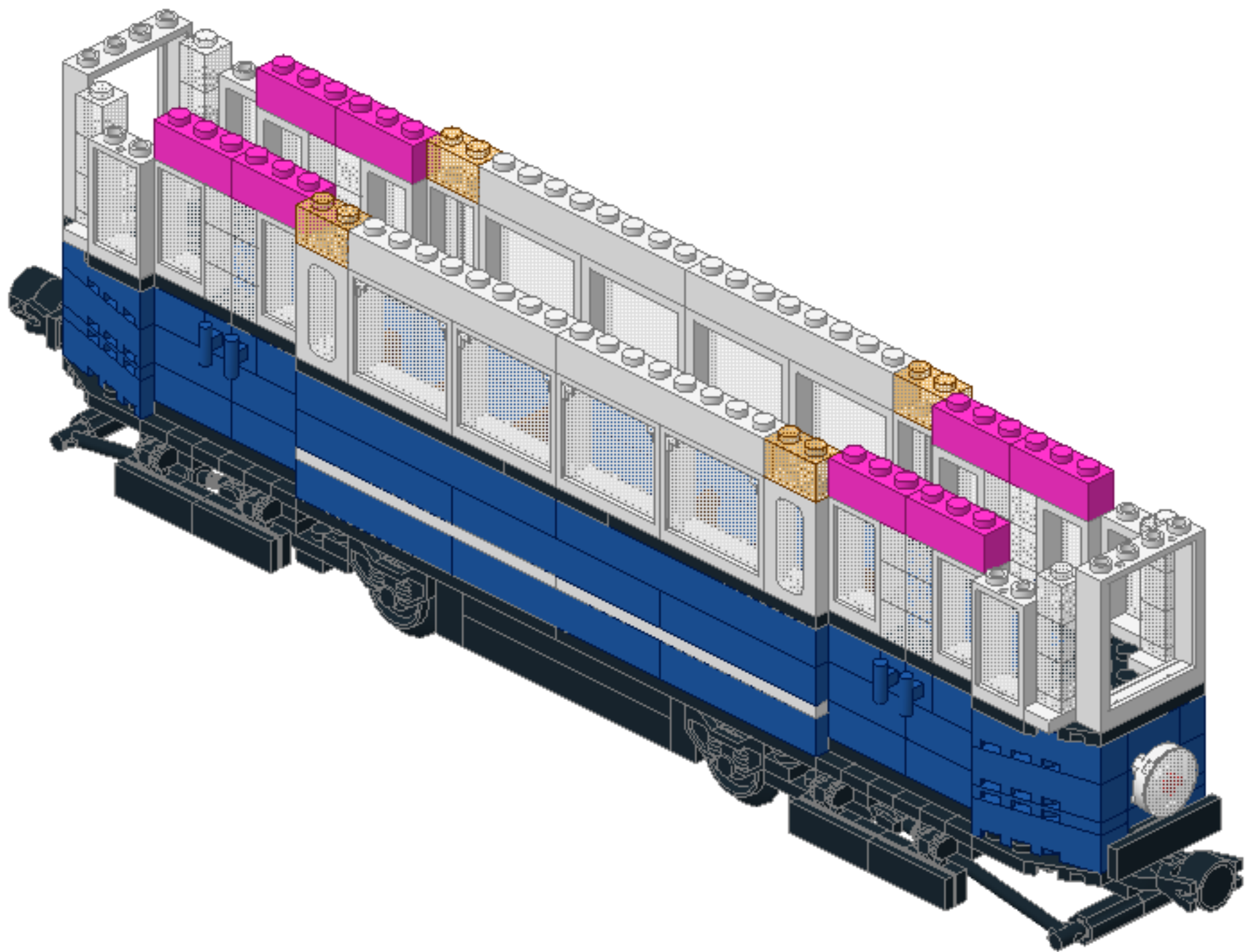
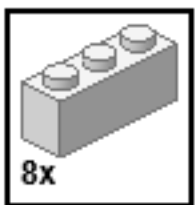

44

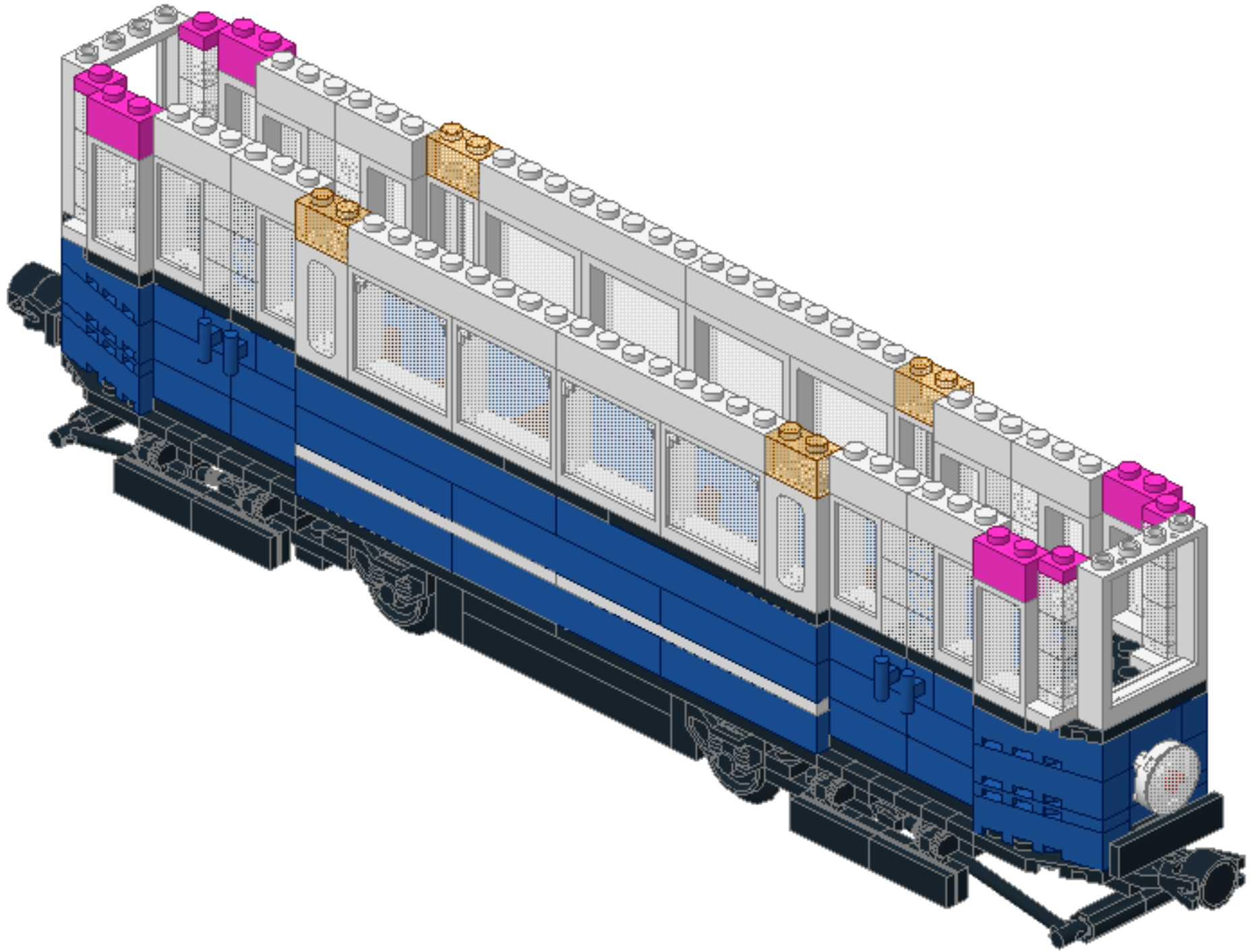
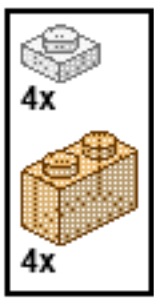

45

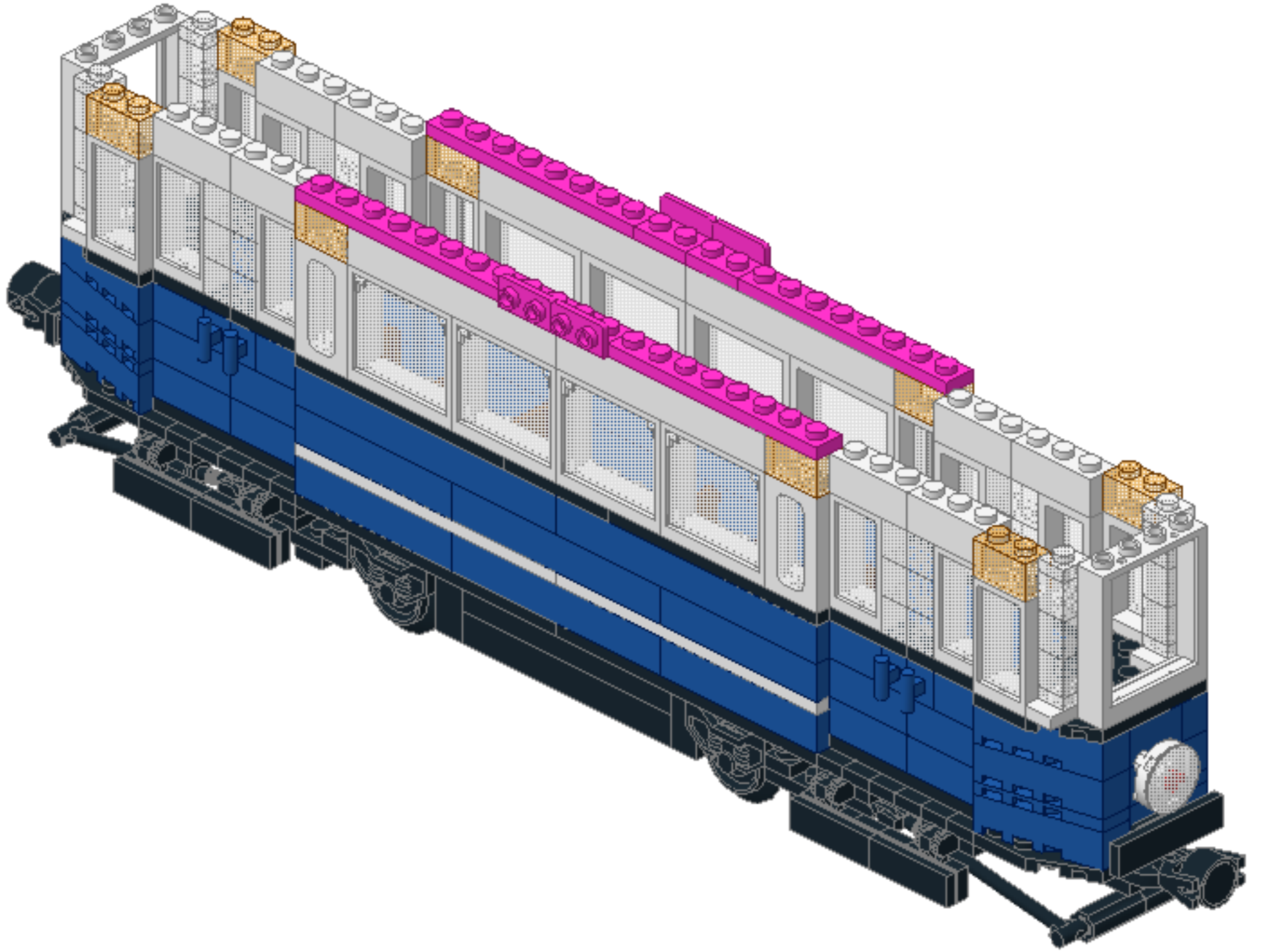
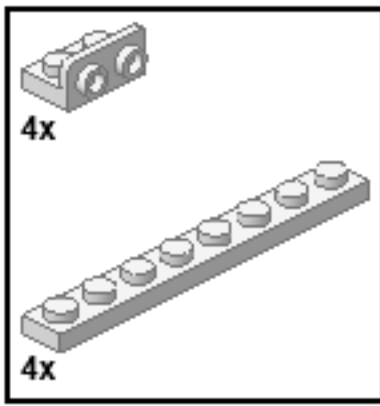



46

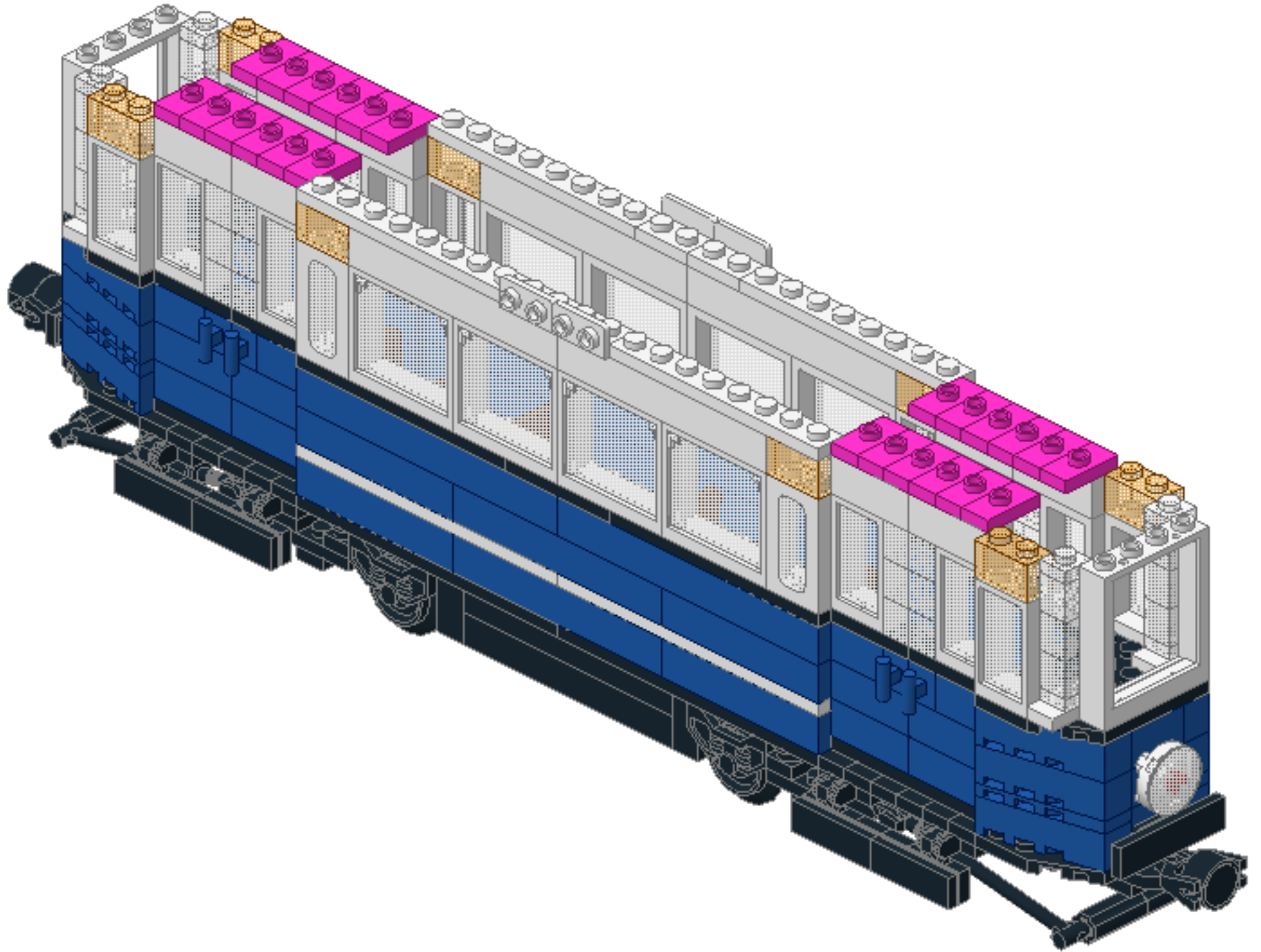



47

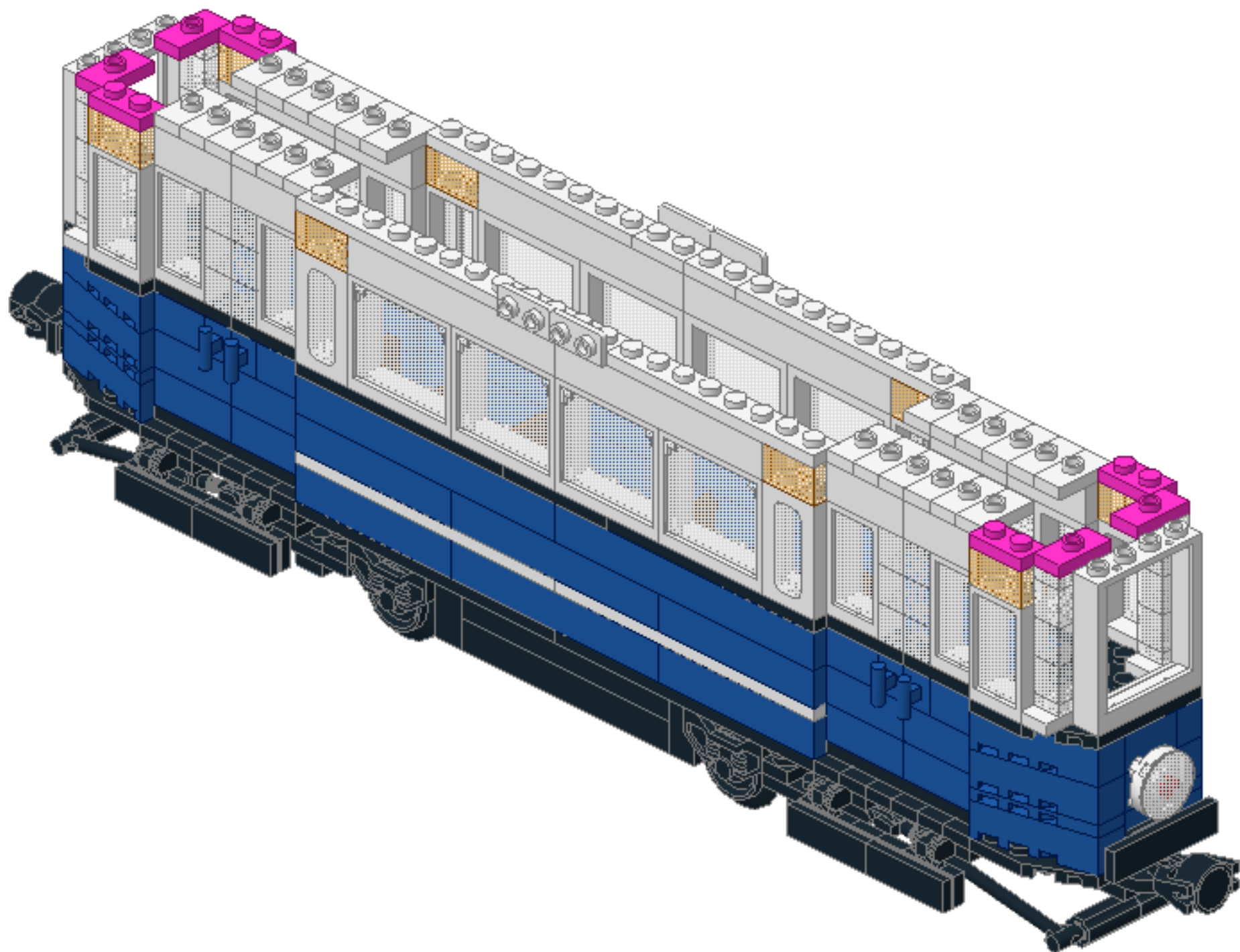
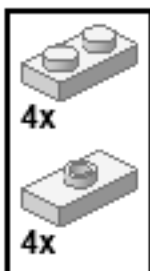

48

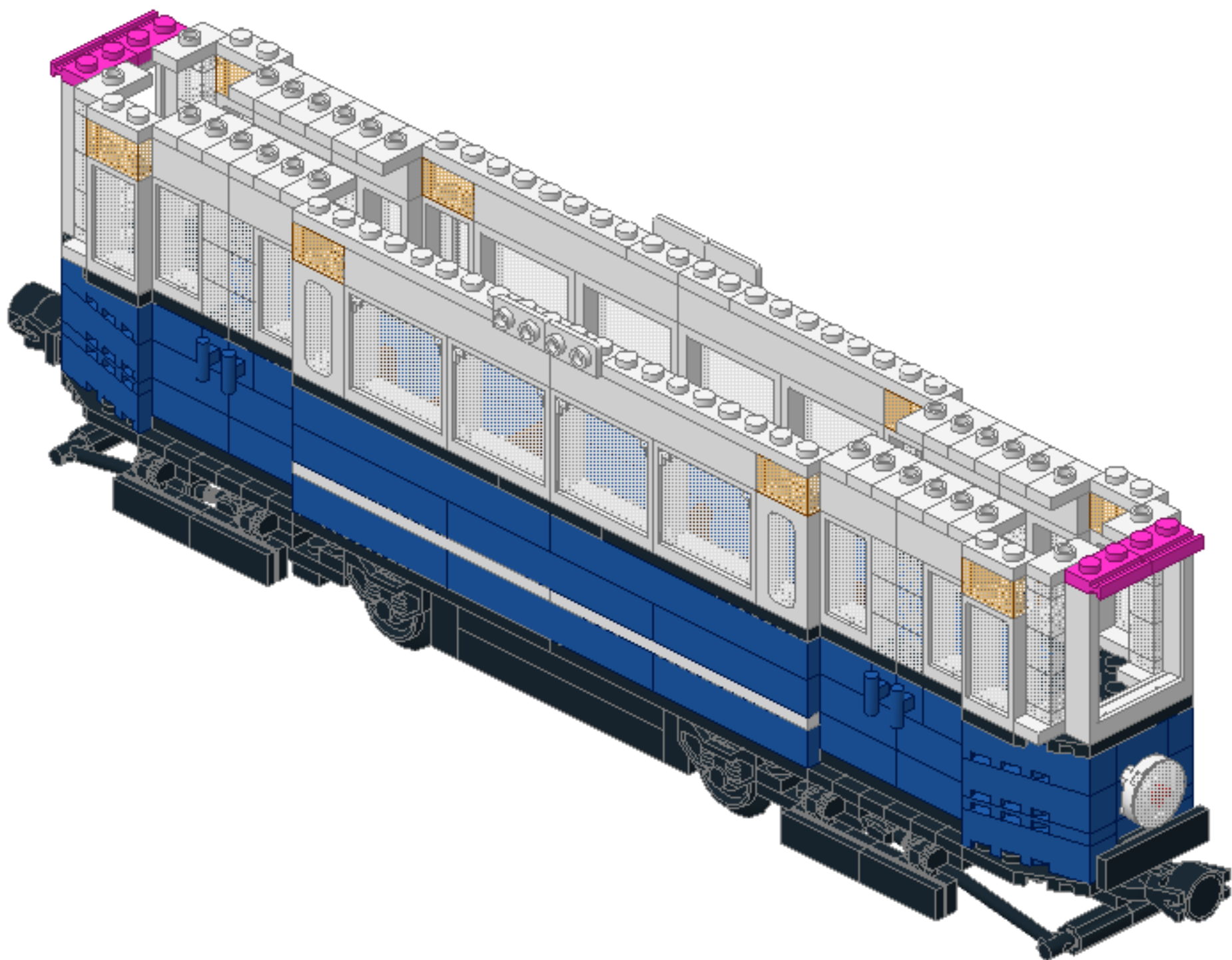
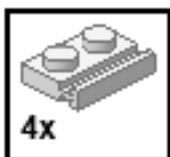

49

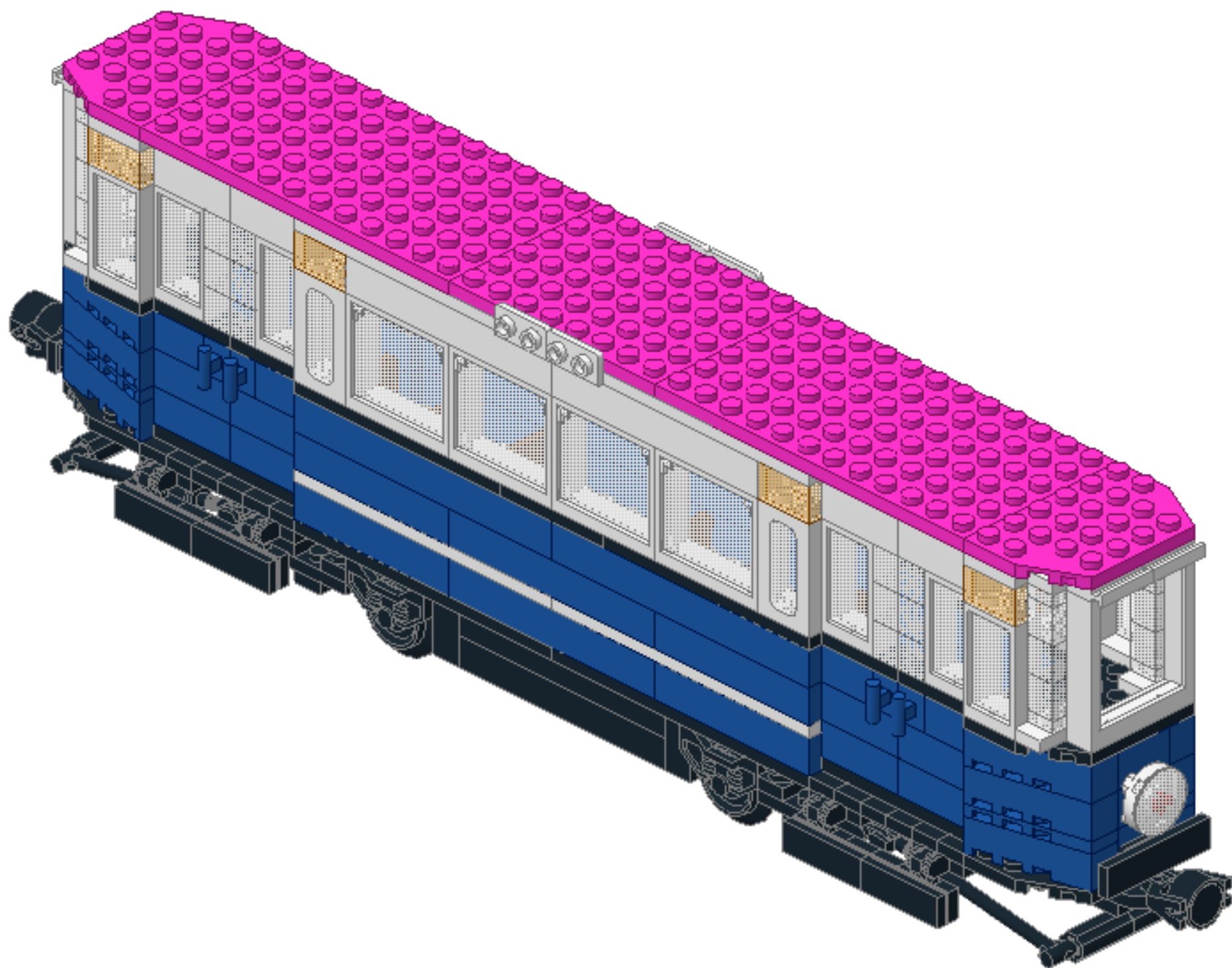
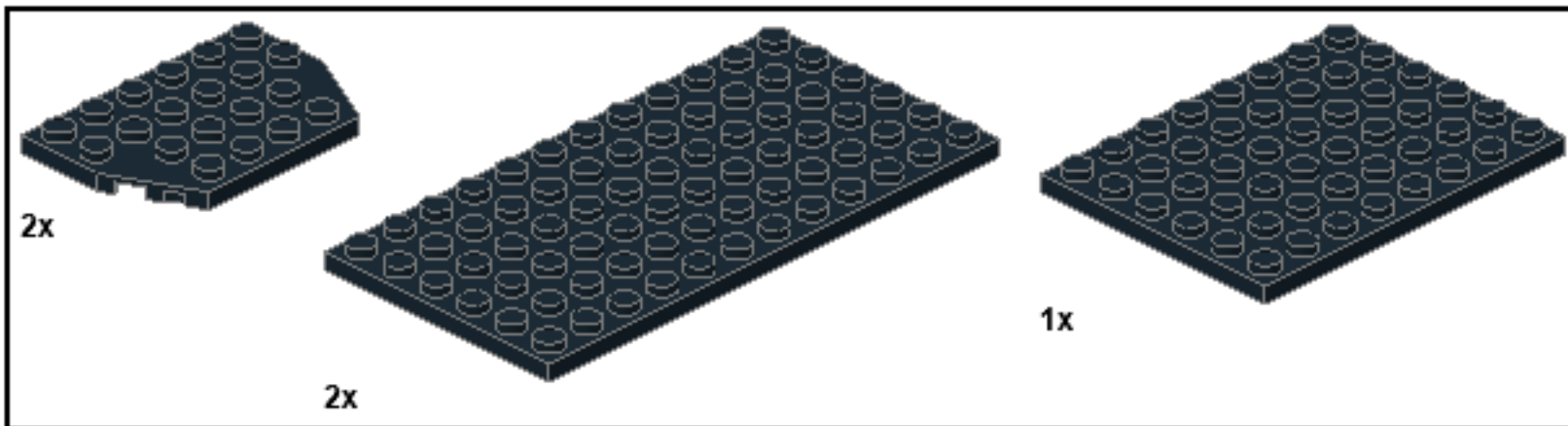

50

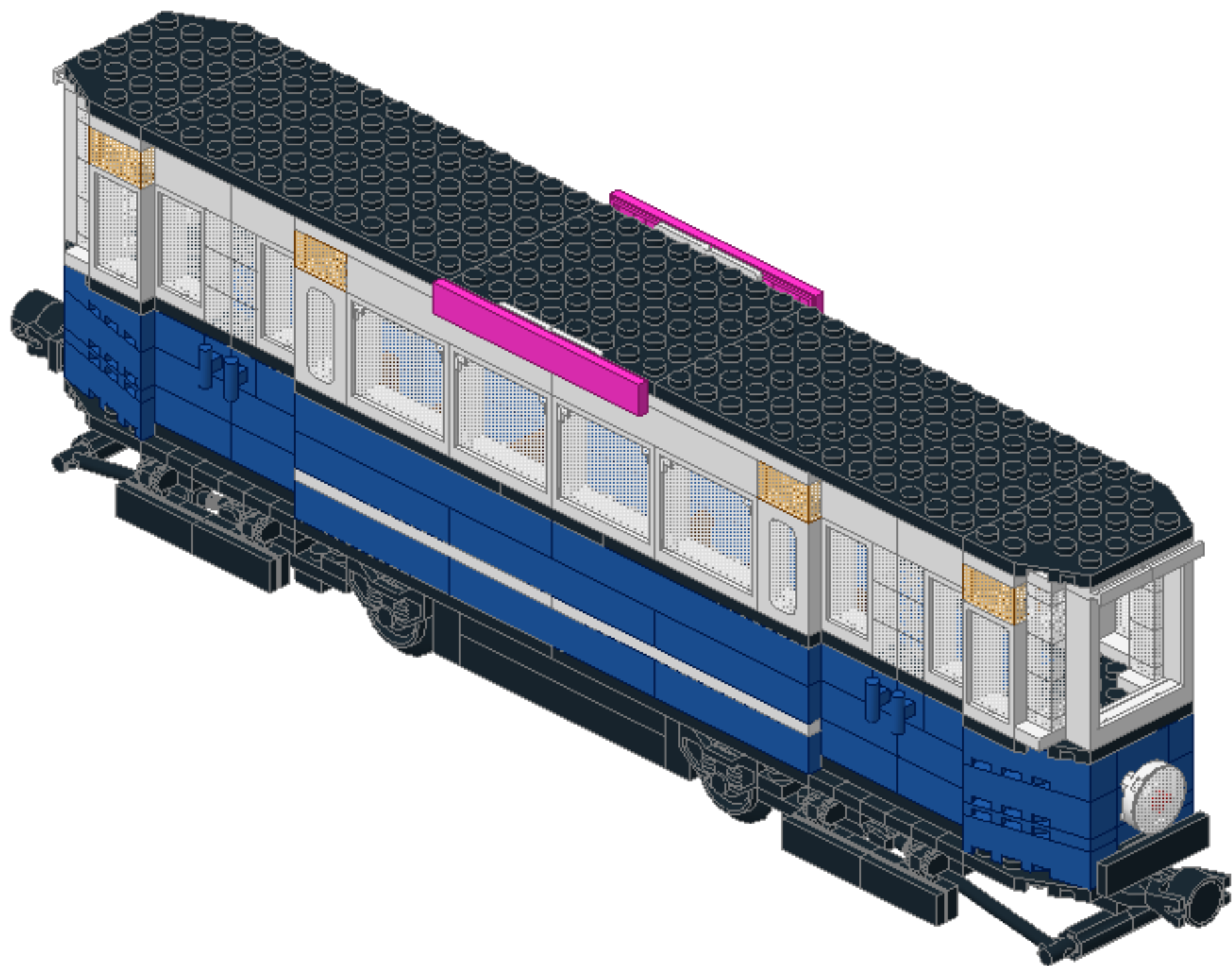
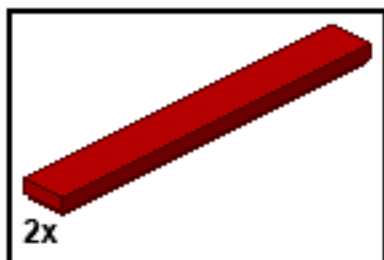



51

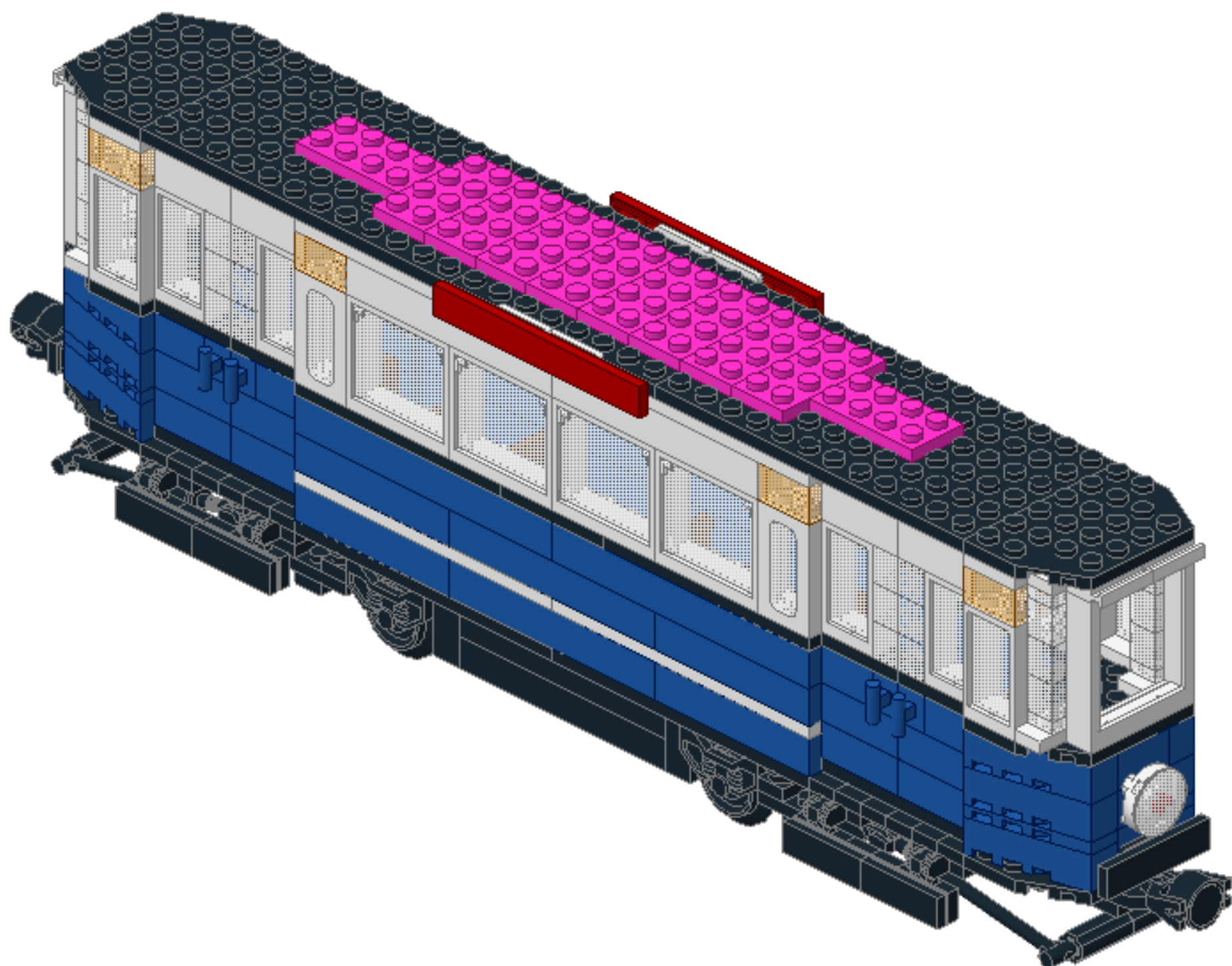
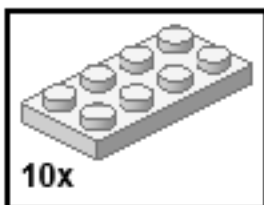

52

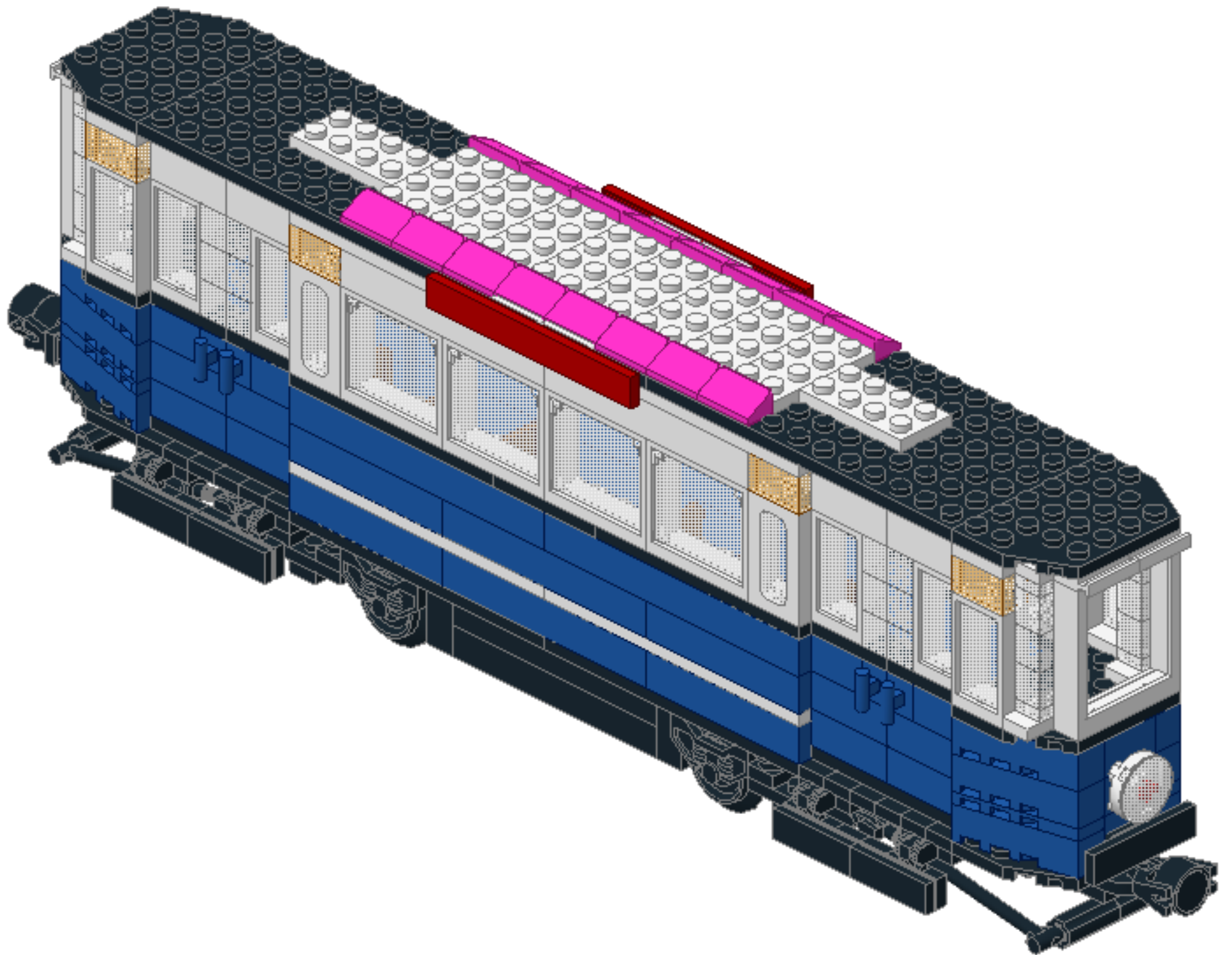
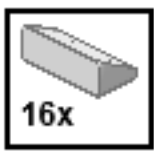

53

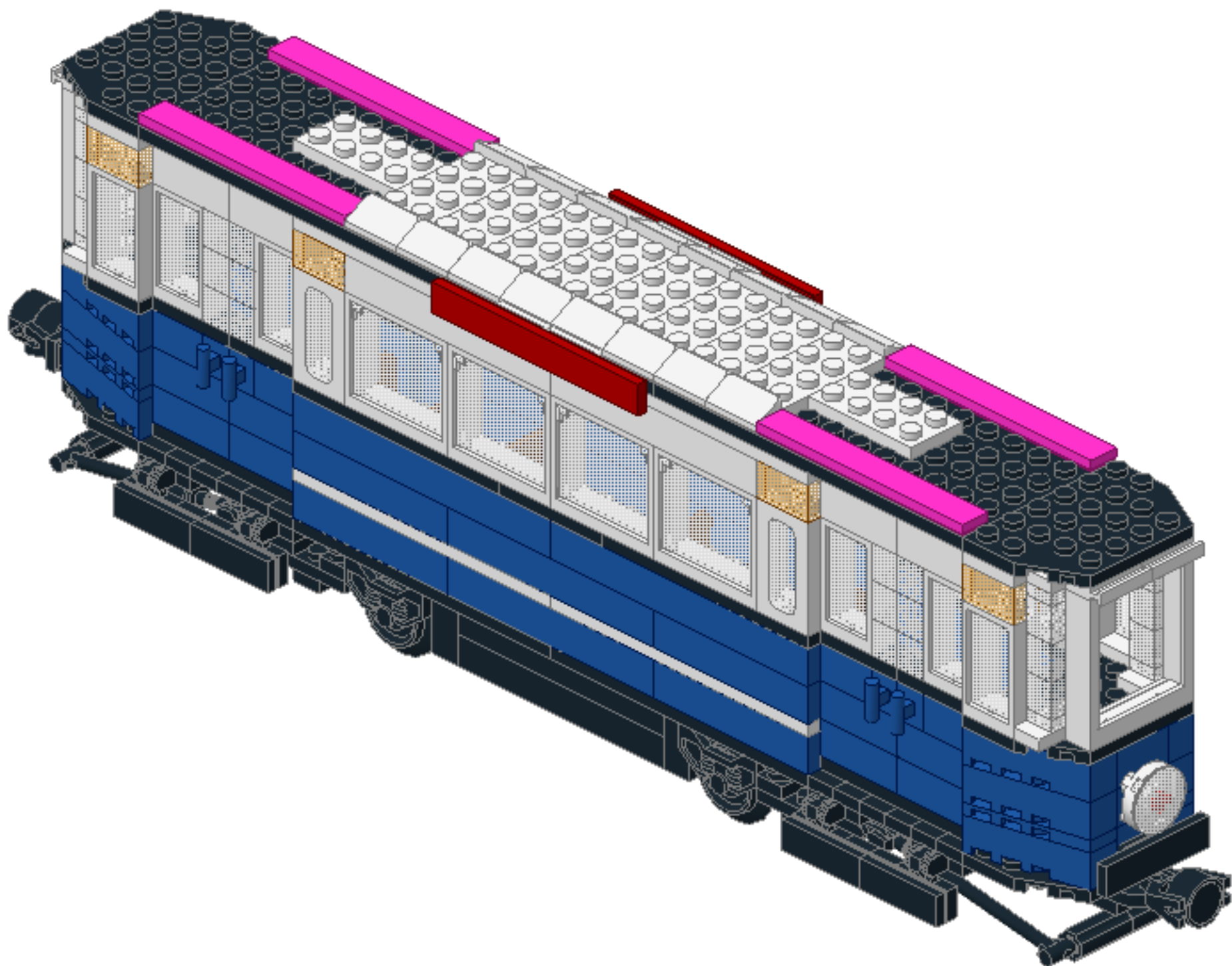
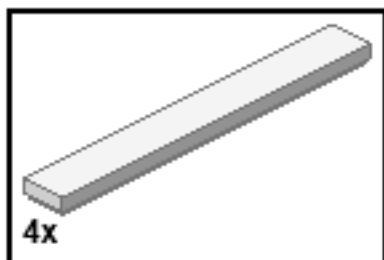

54

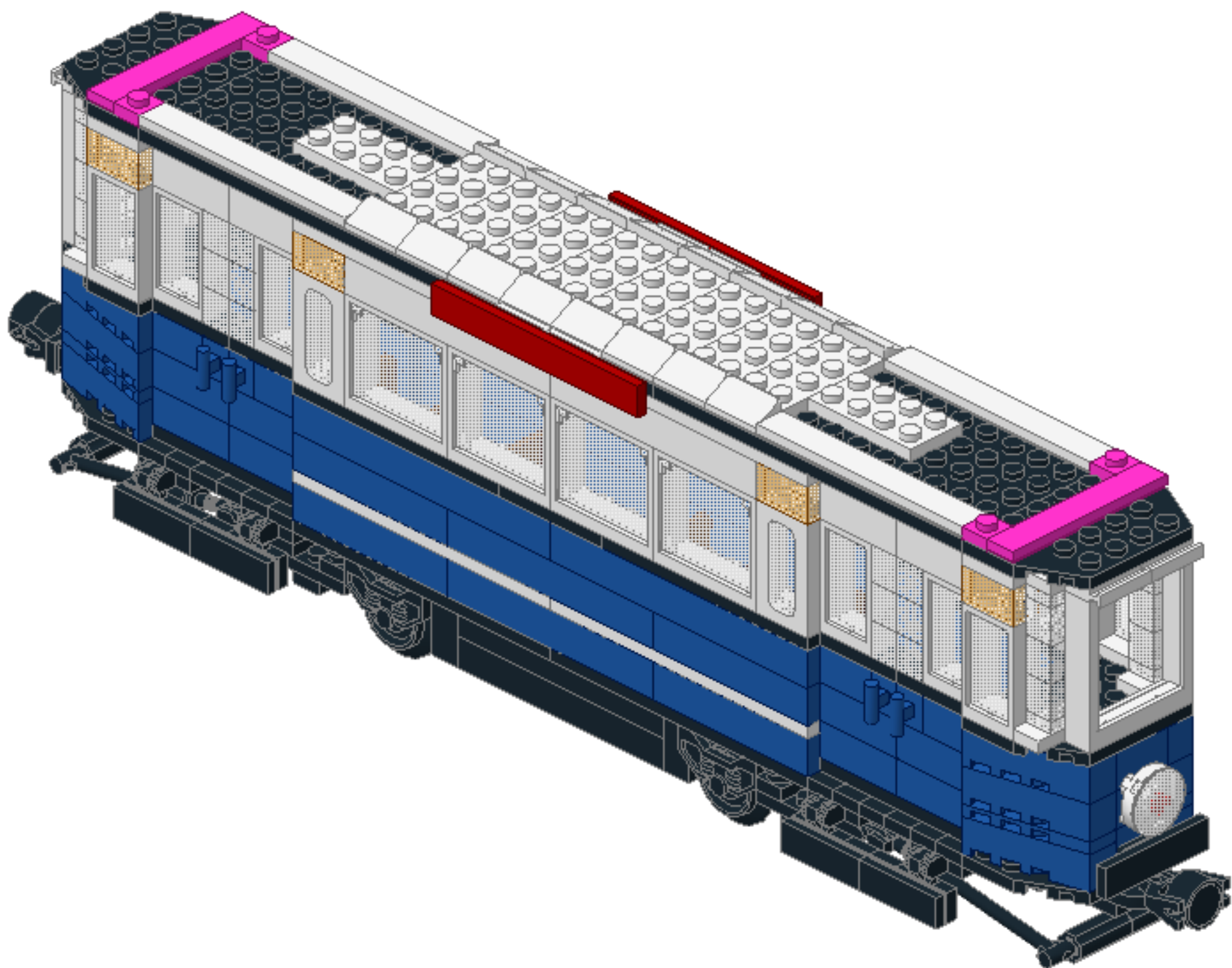
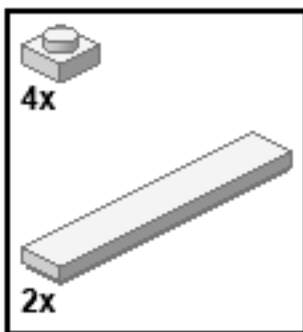



55

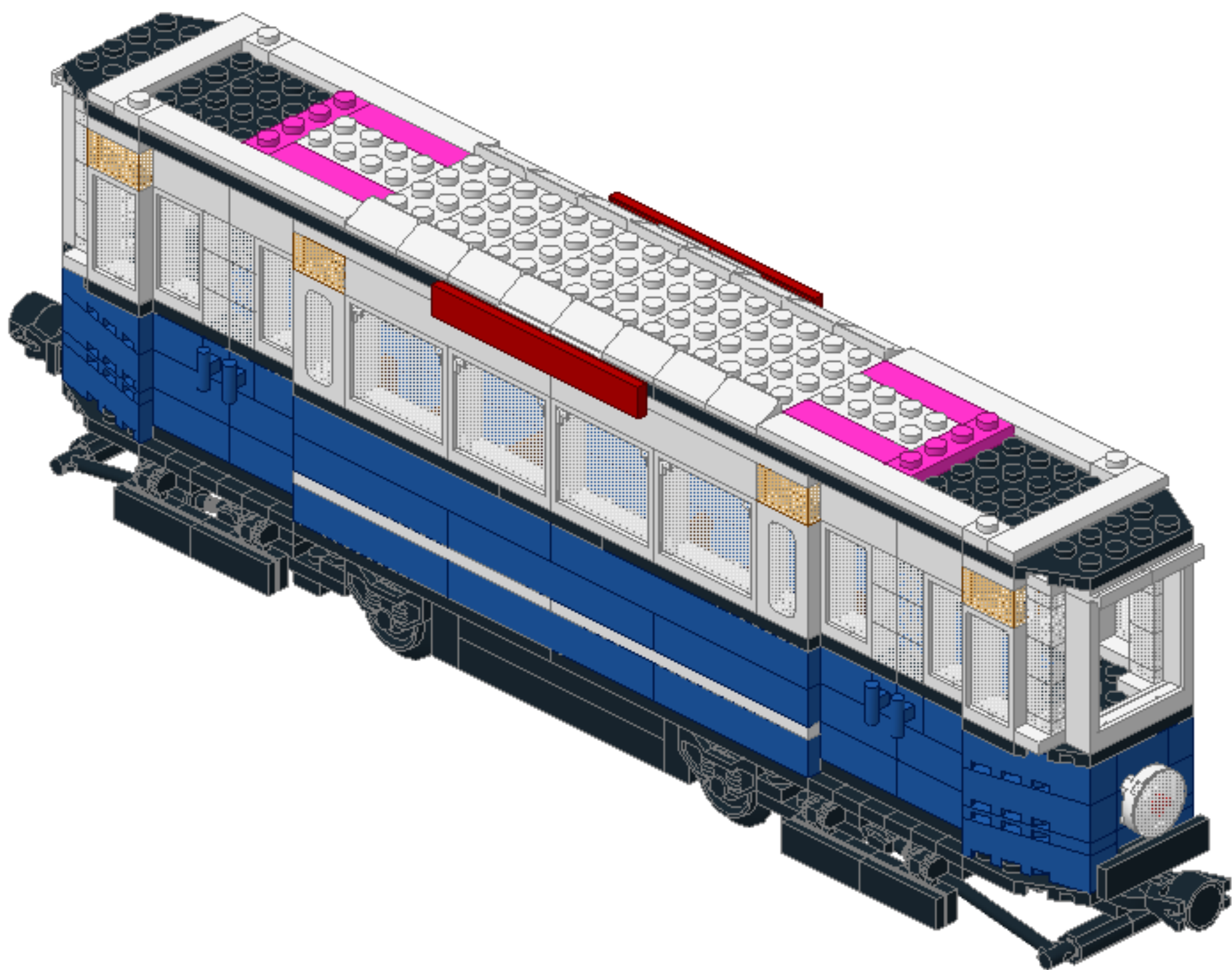
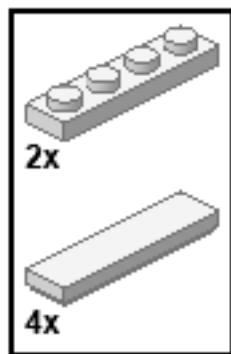

56

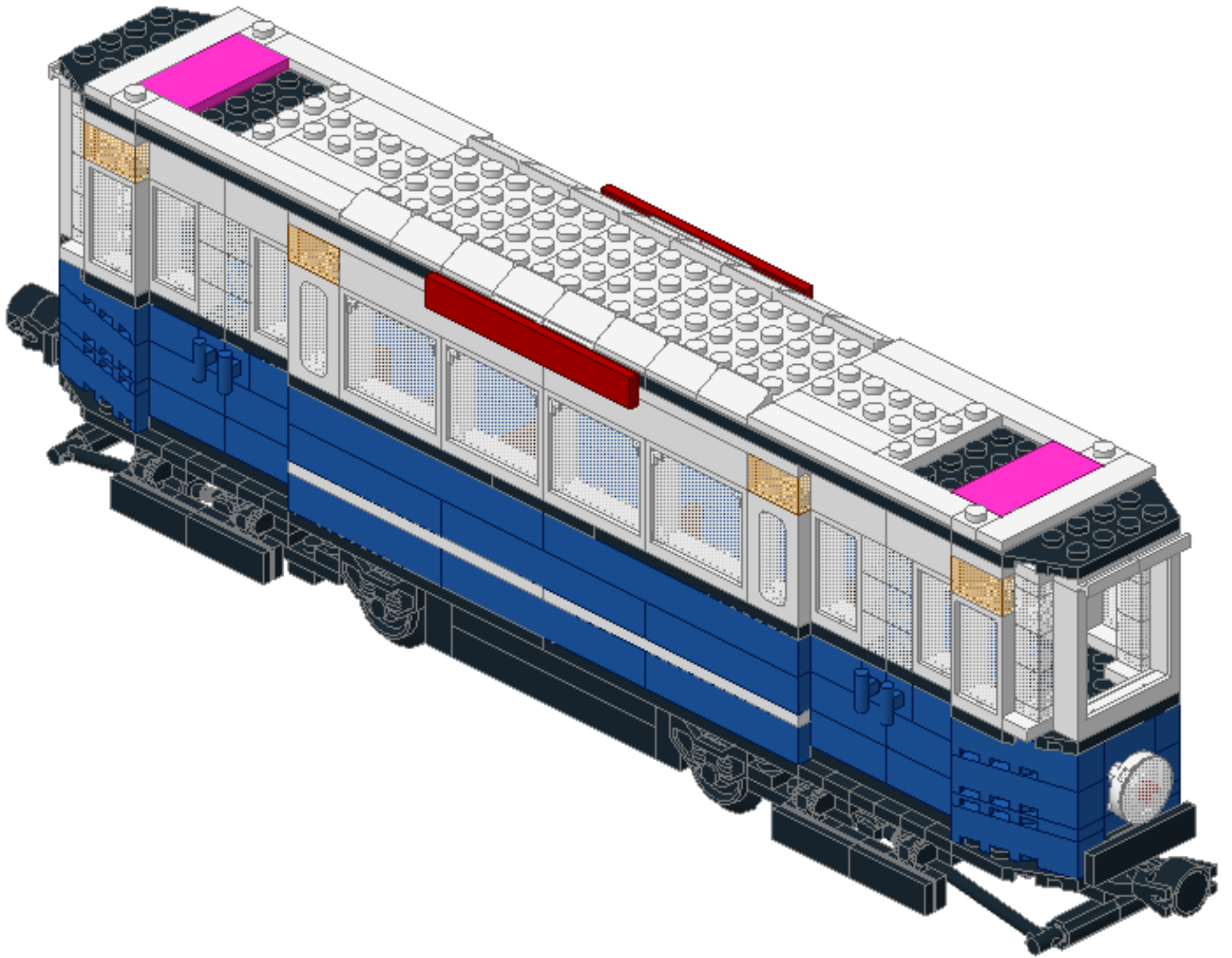
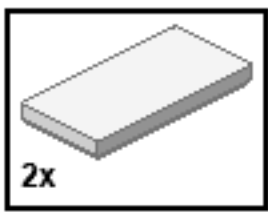

57

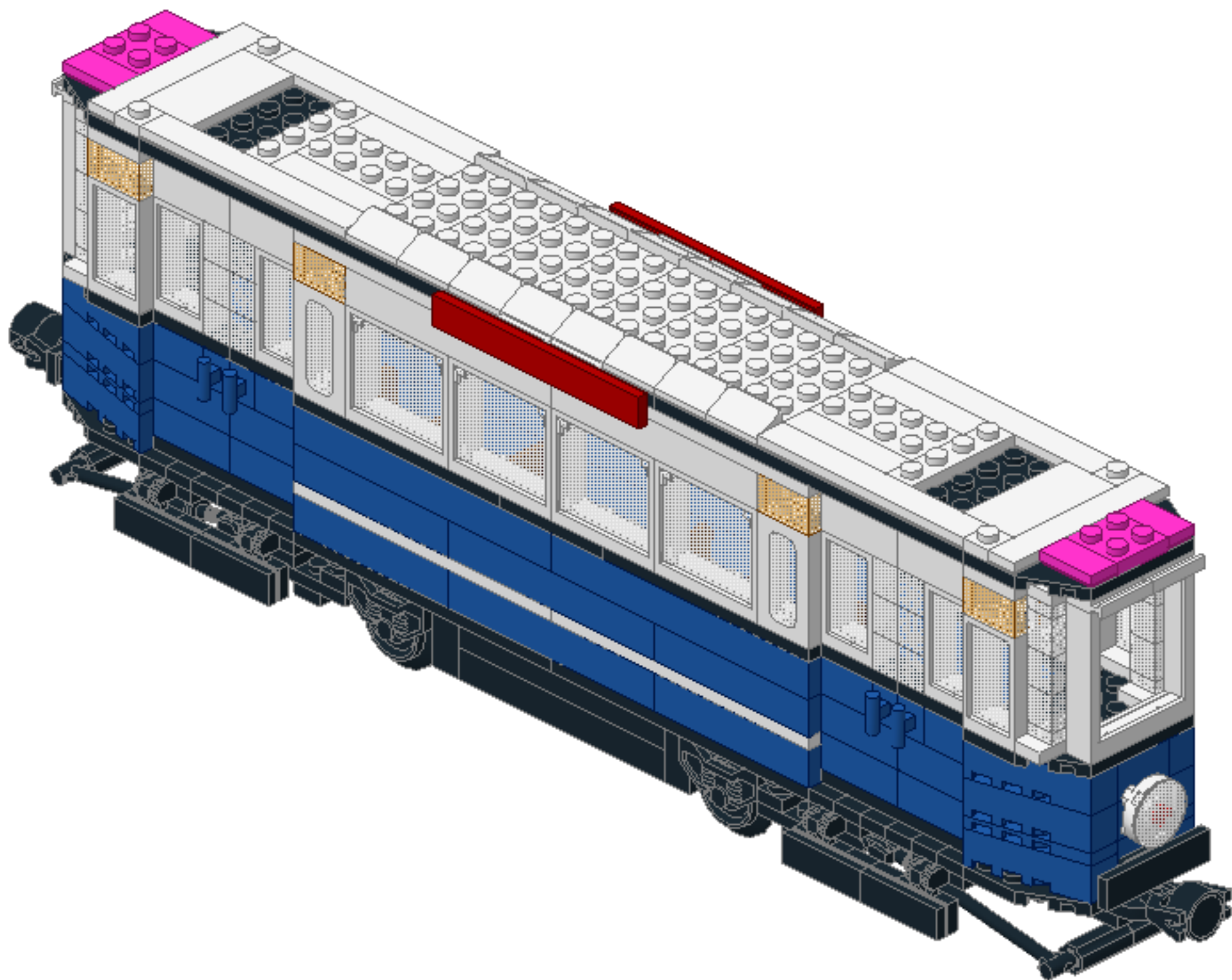
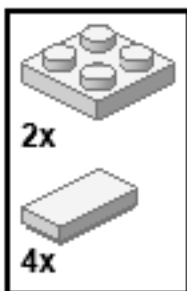





59

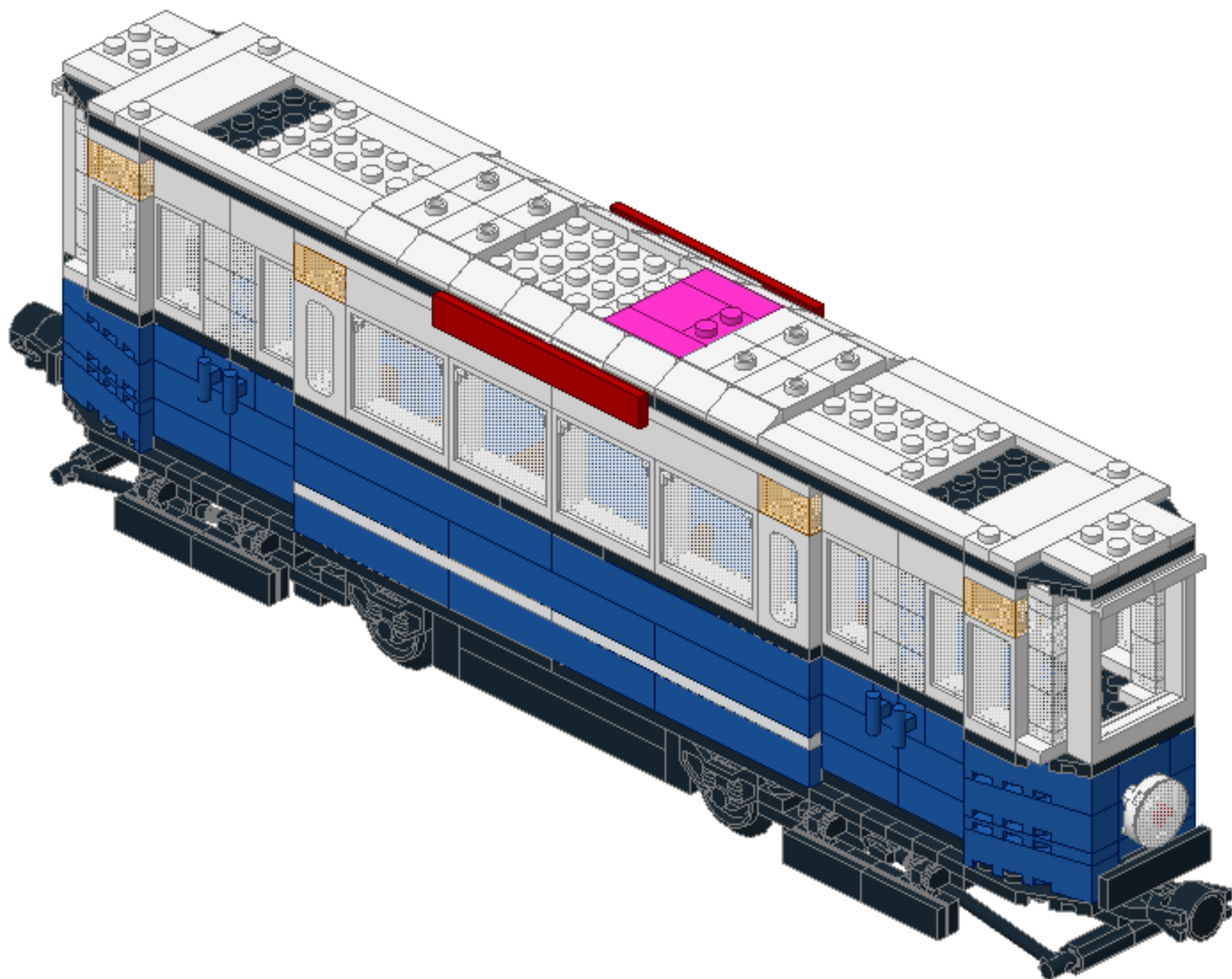
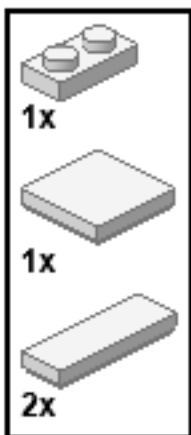

60

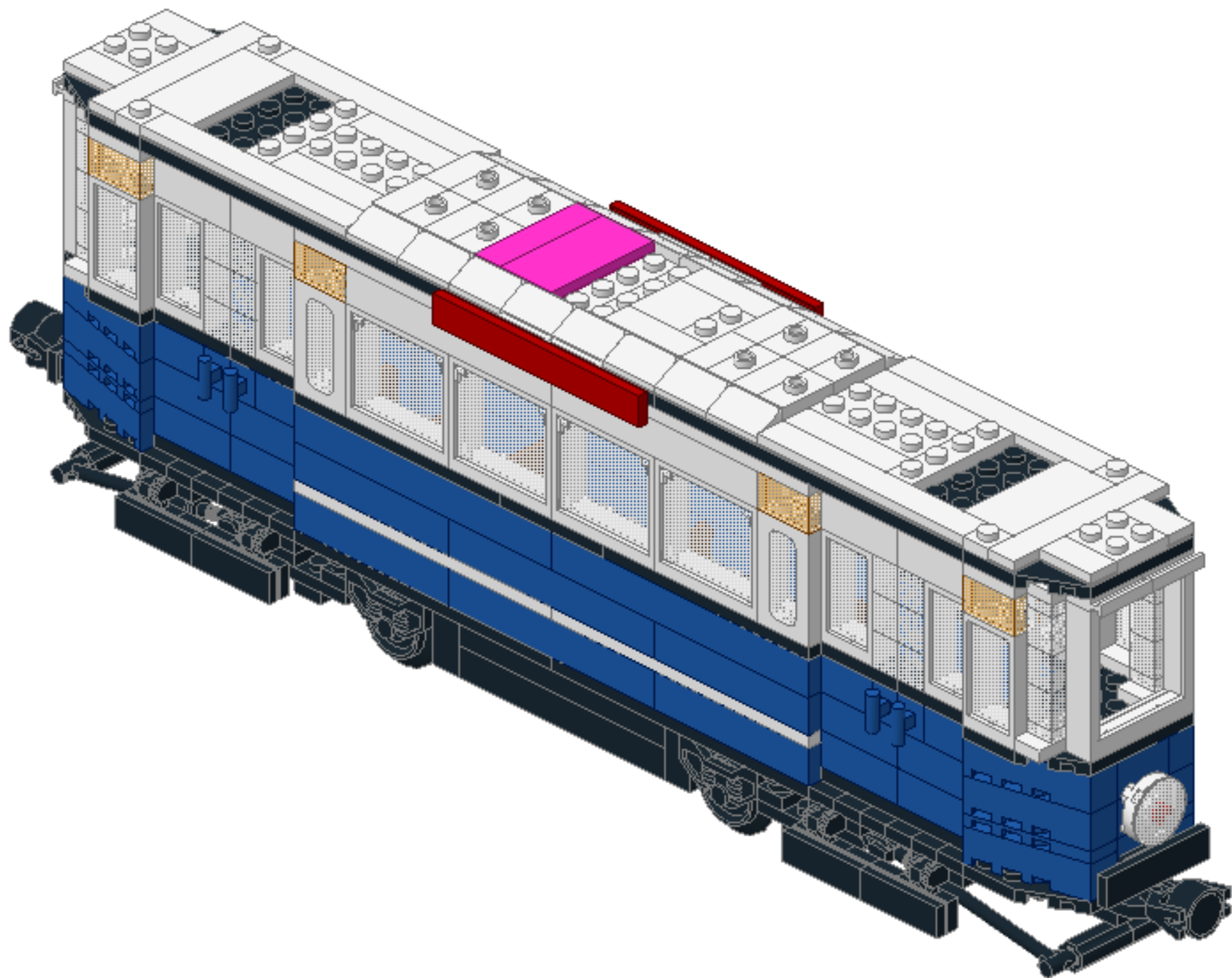
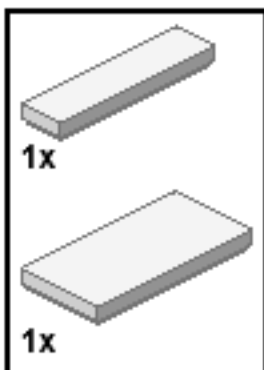

61

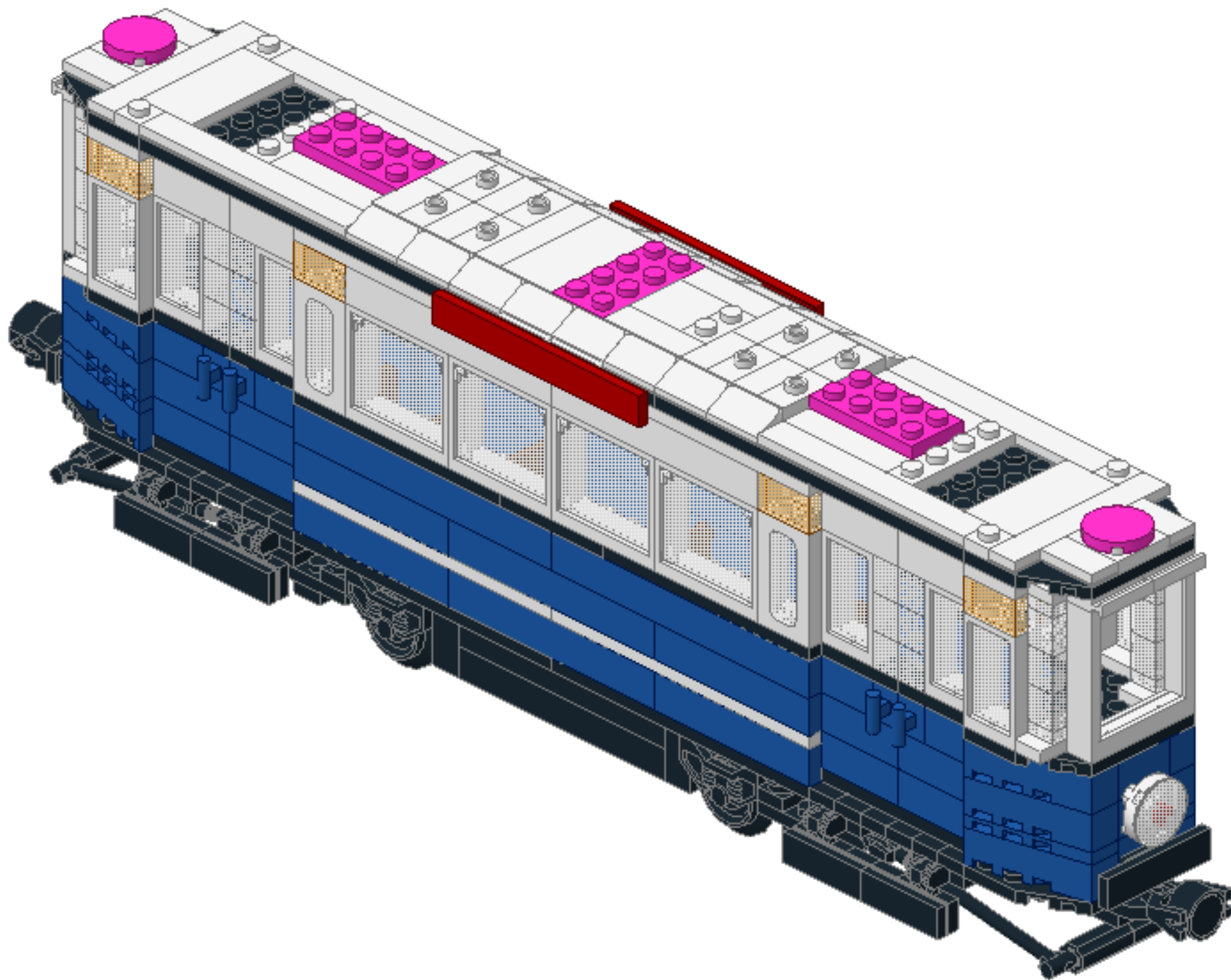
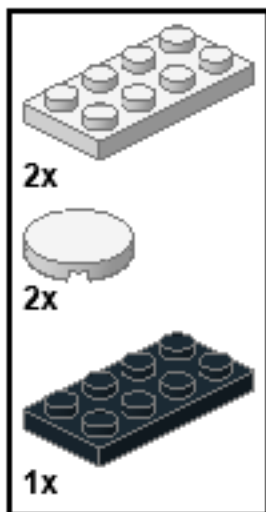

62

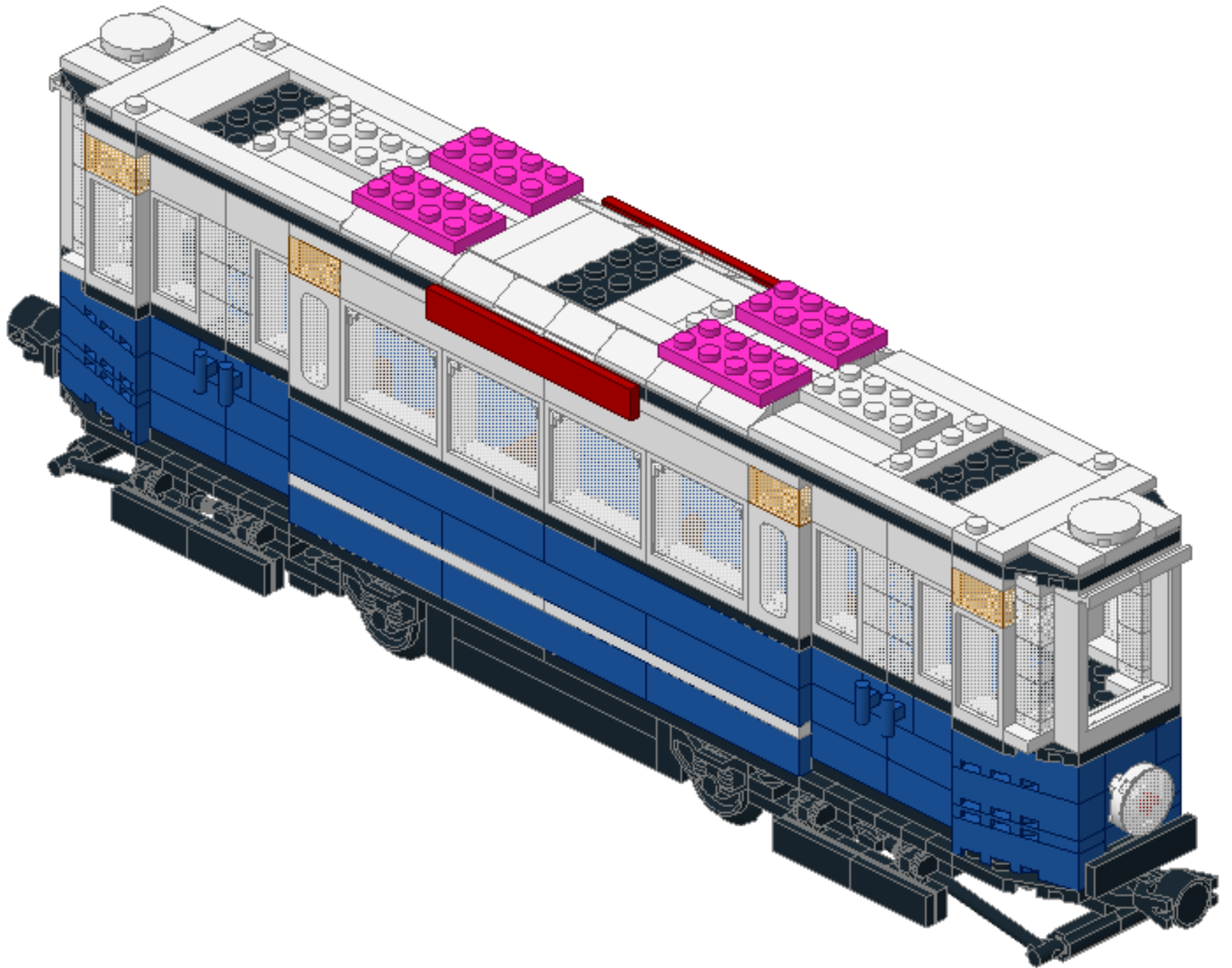
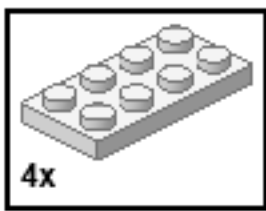



63

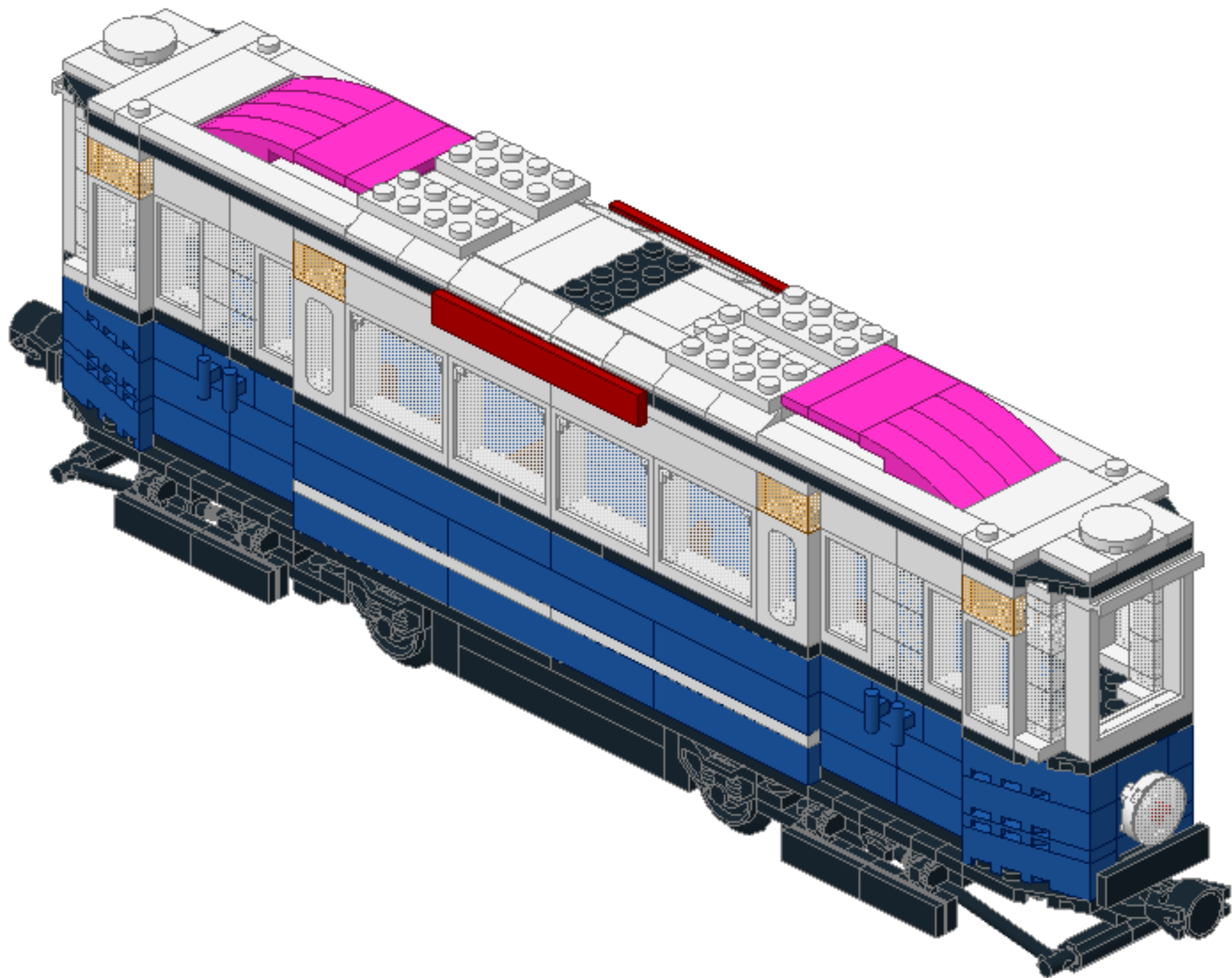
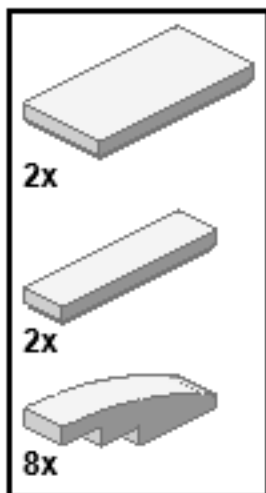

# 64

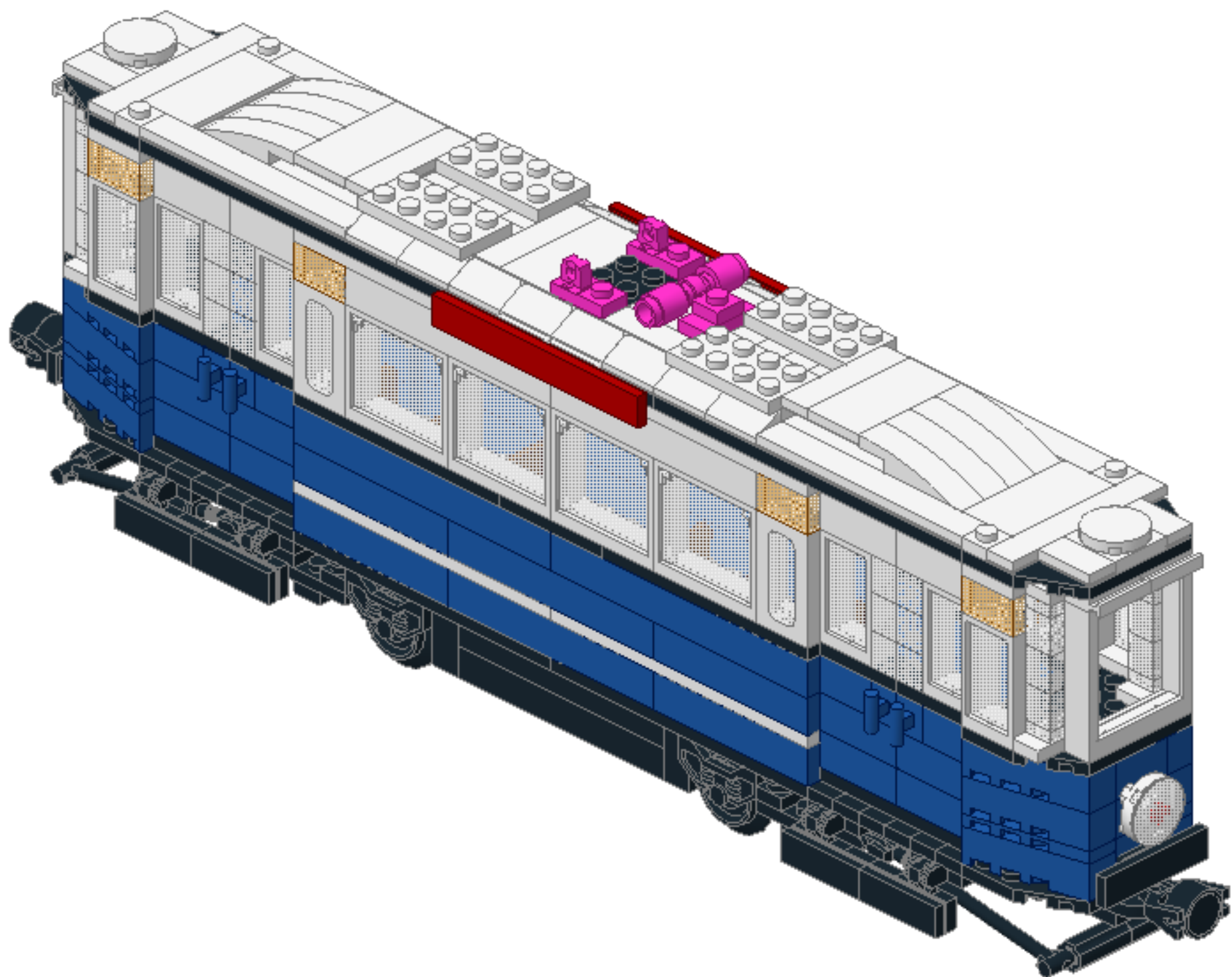
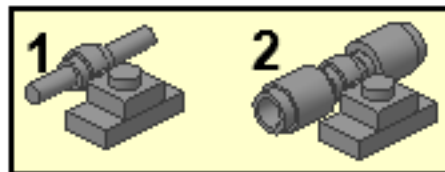
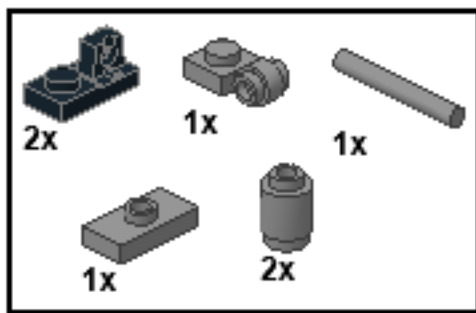

65

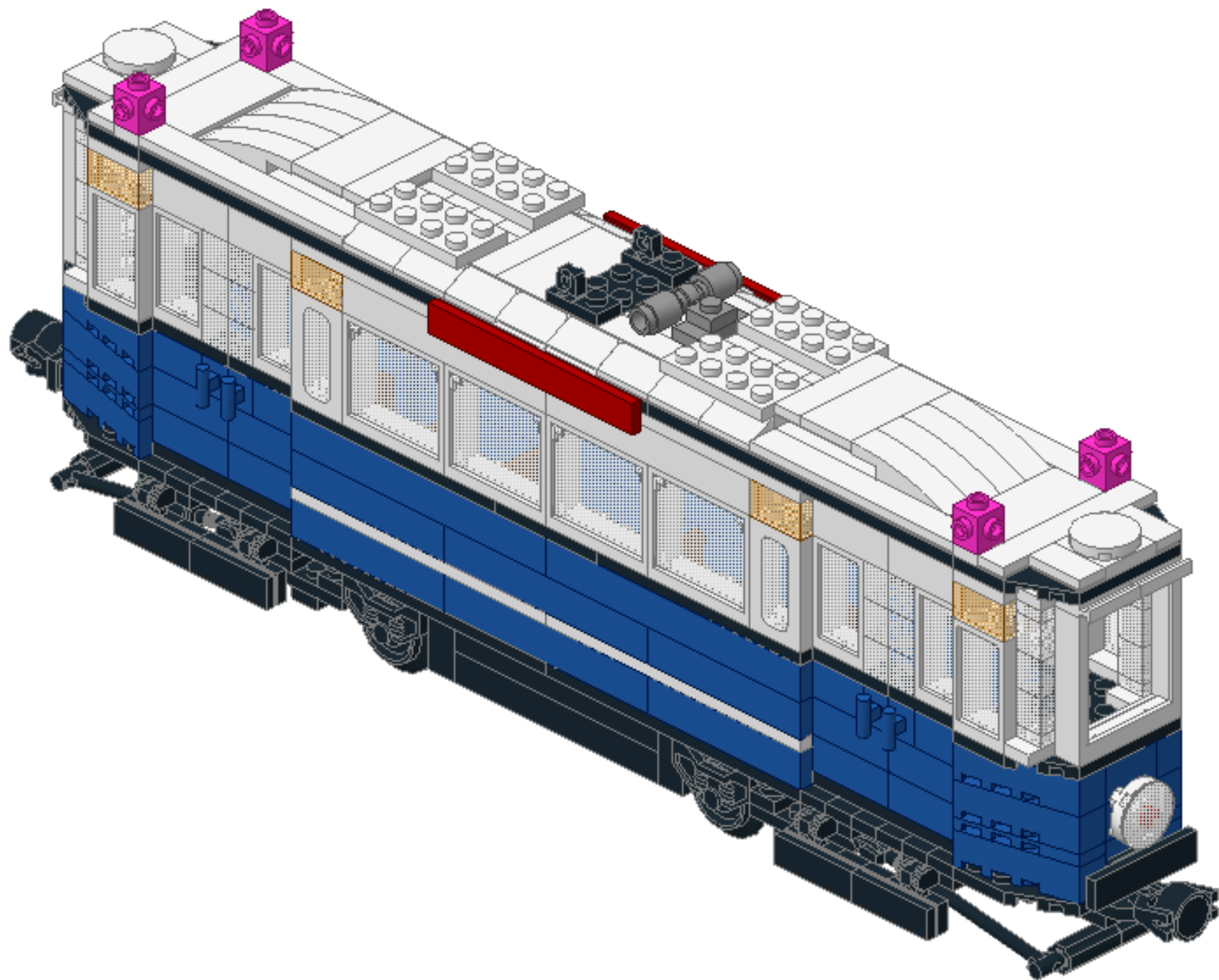

66

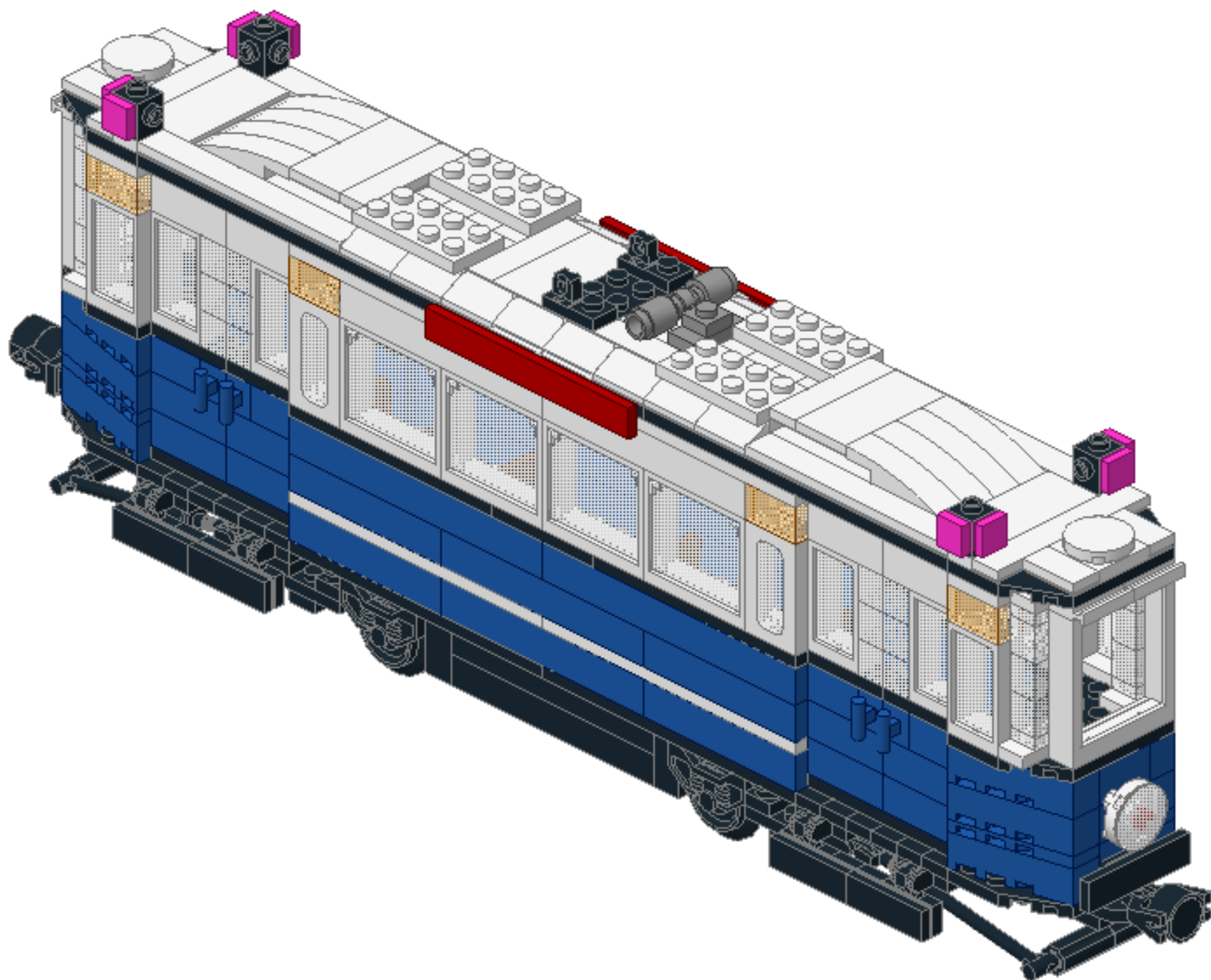
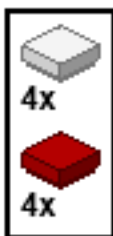



67

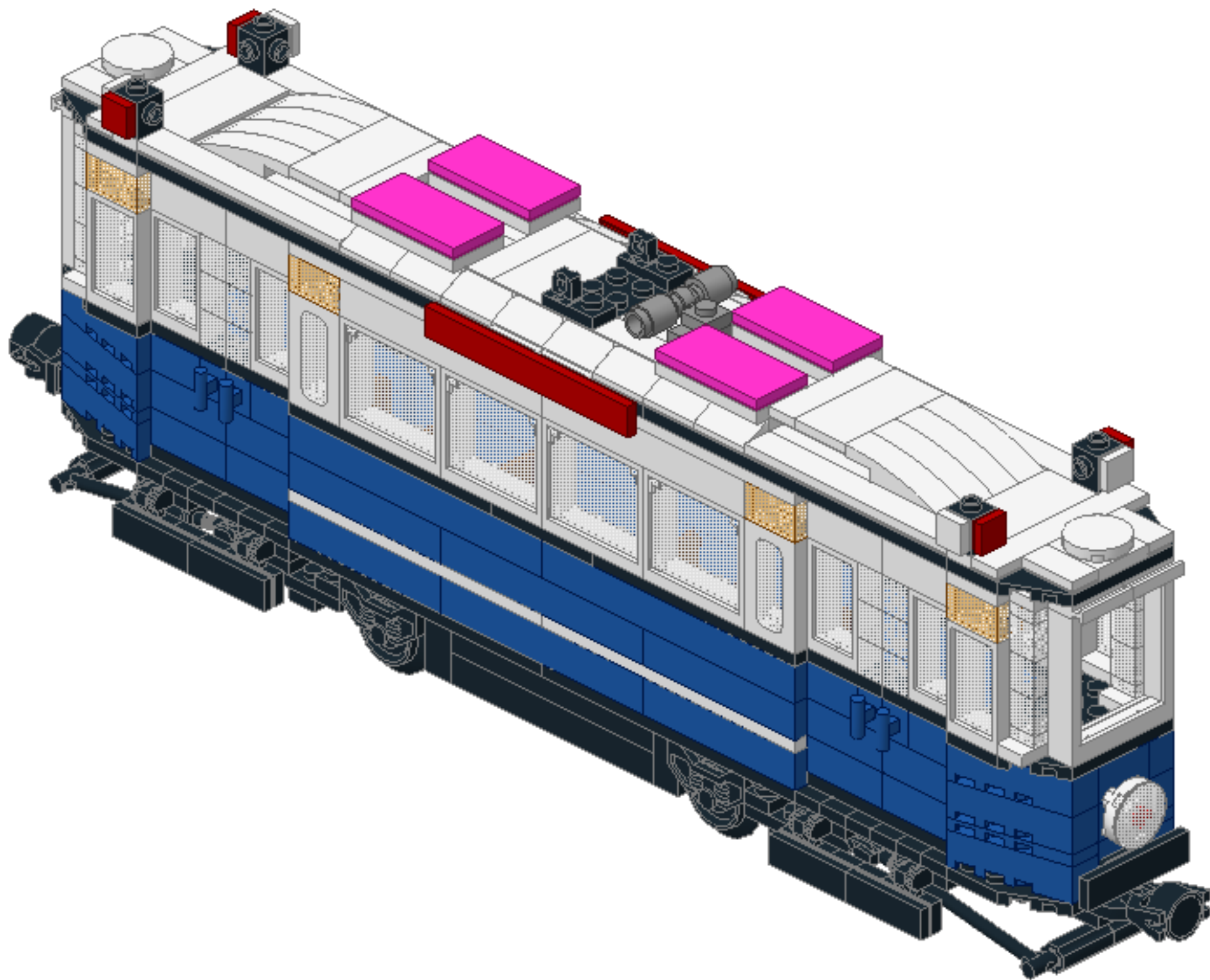
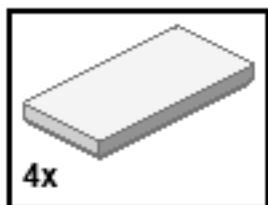

68

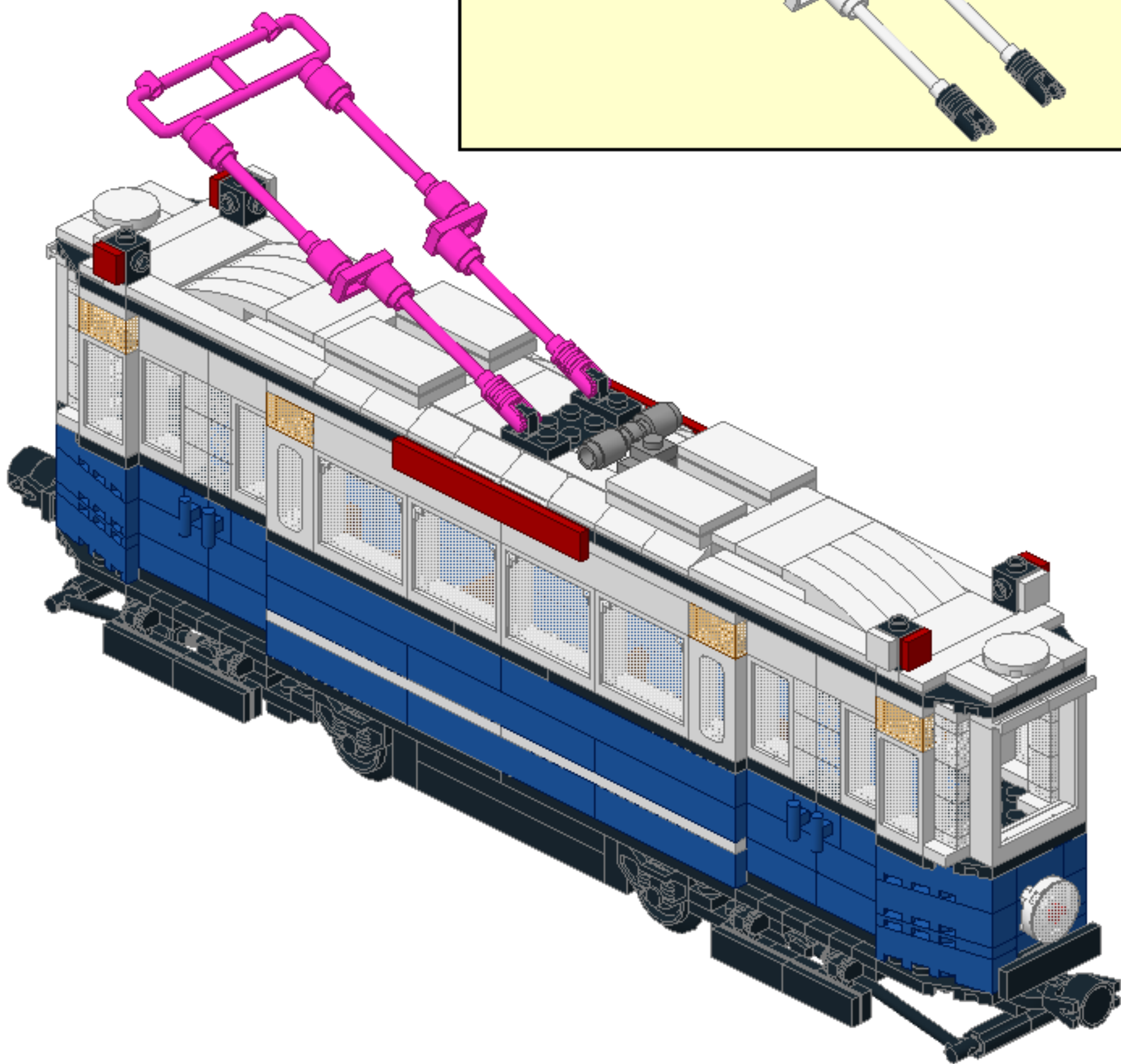
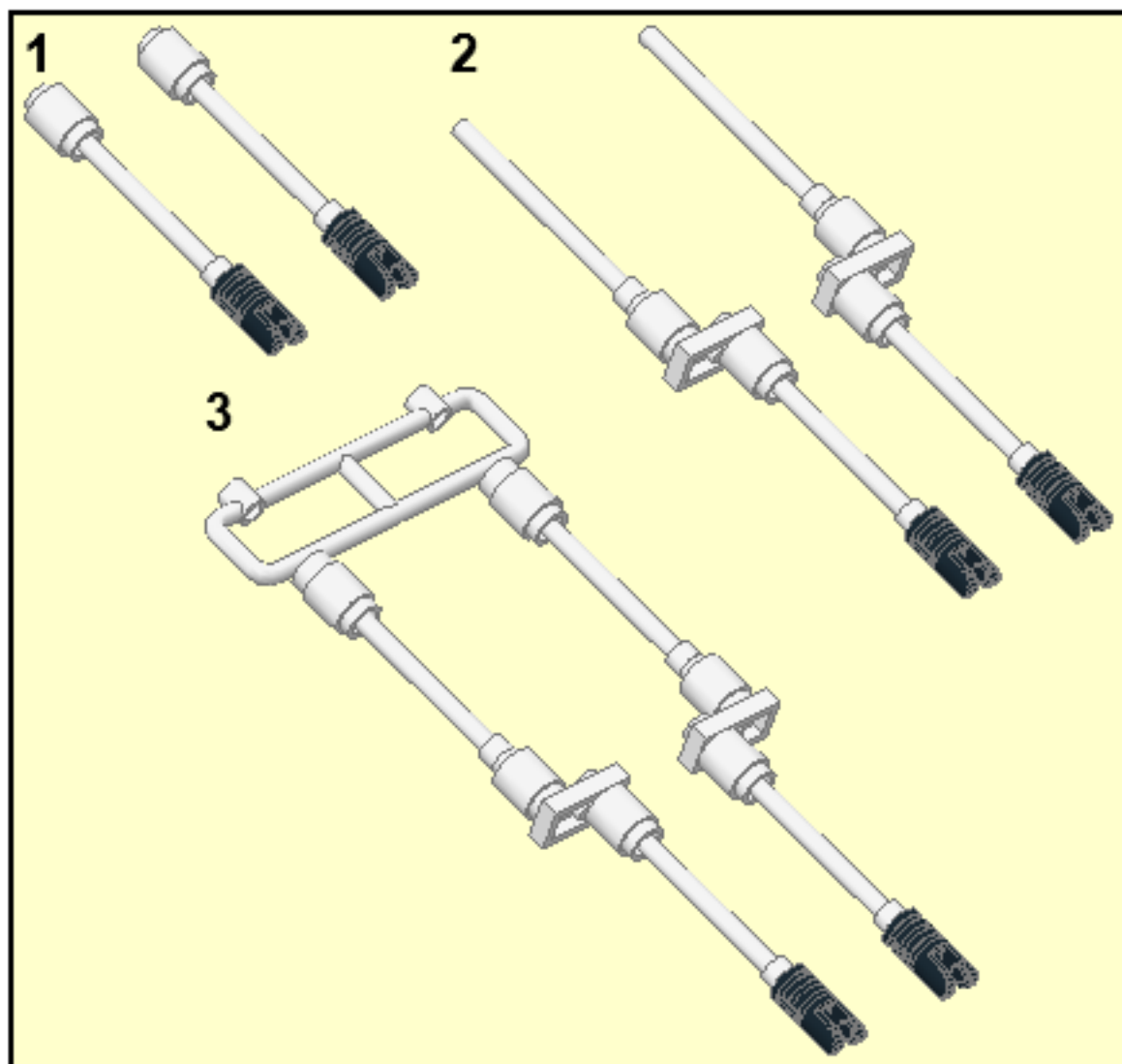
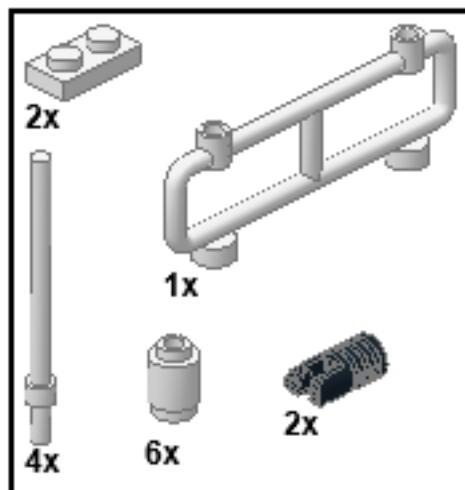

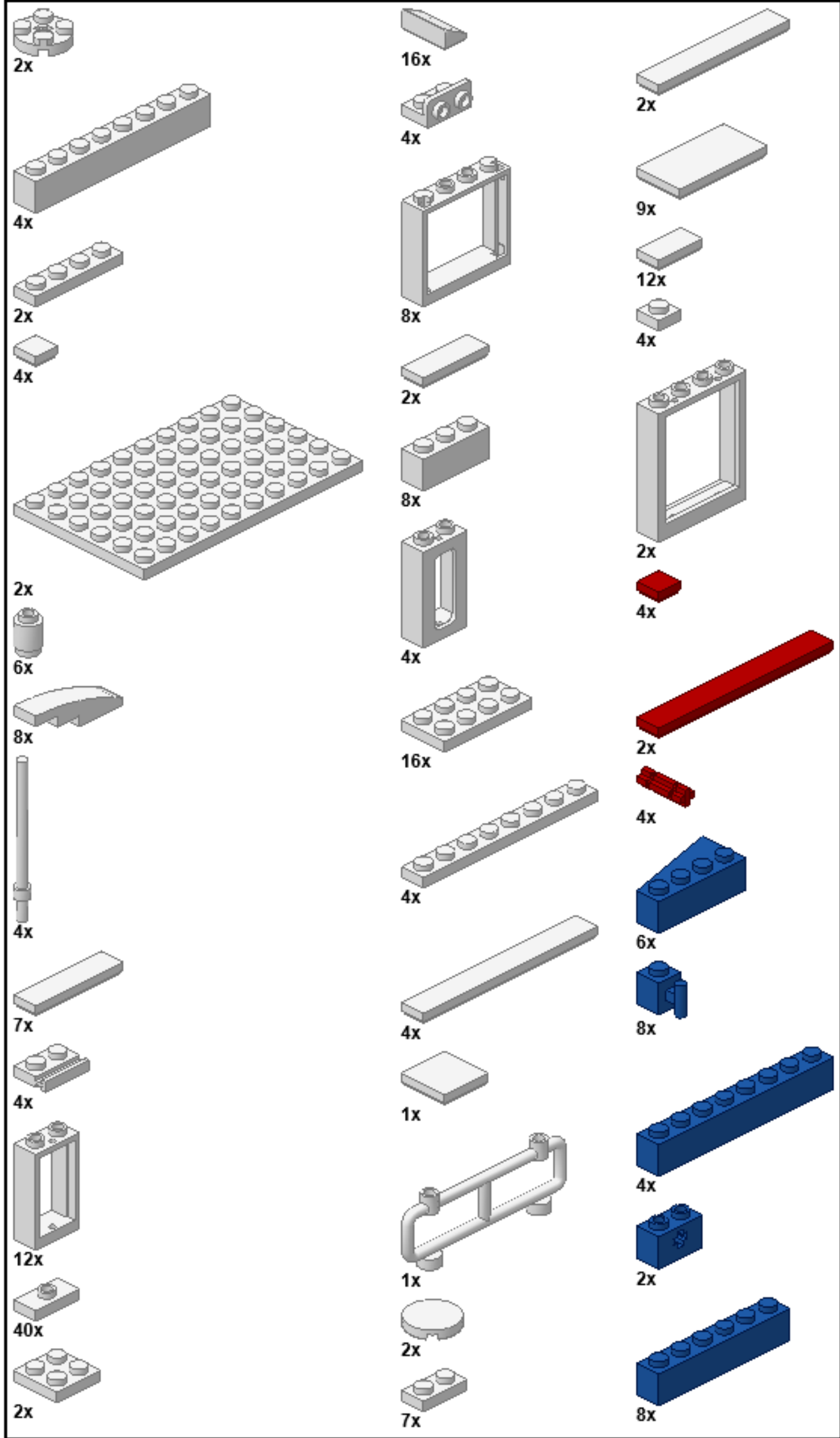

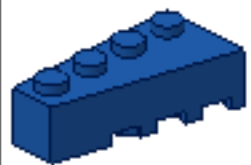

6x

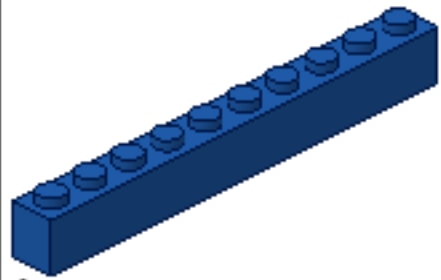

4x

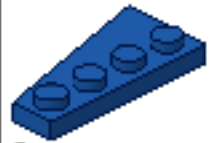

2x



12x

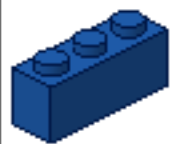

16x



2x



2x

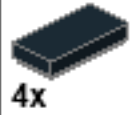

4x

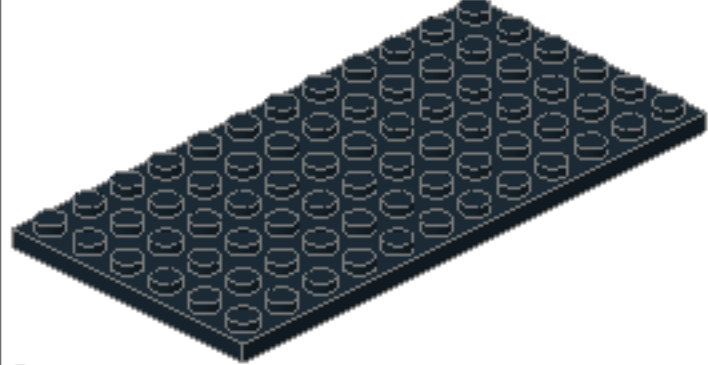

2x



12x



1x



12x



4x



2x



8x



4x



4x



2x



8x



6x



2x

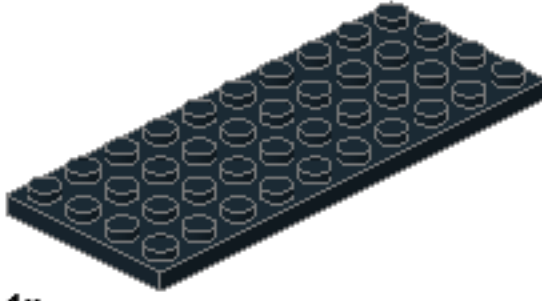

1x



2x



24x



6x



2x



4x



4x



4x

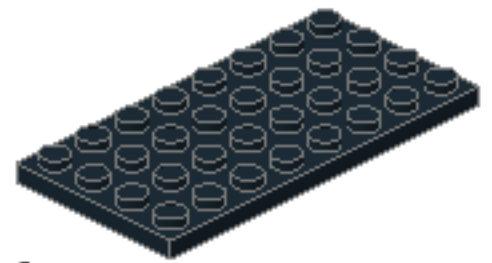

3x

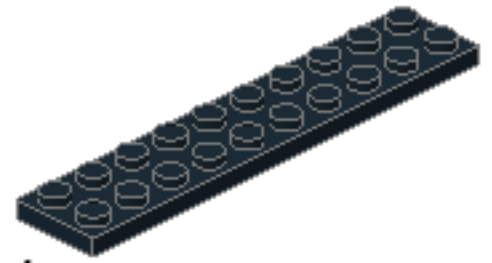

4x



4x



6x

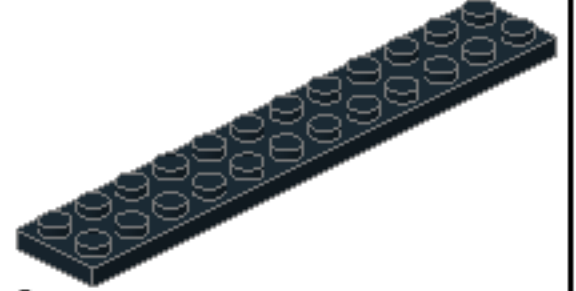

2x

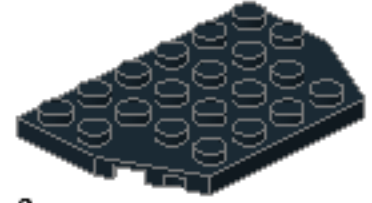

6x



4x



2x



2x



3x



4x



8x



