

1

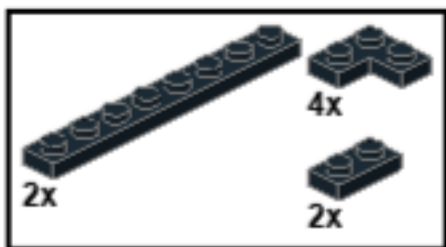

2

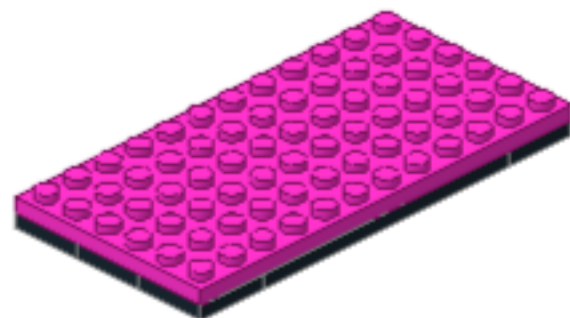
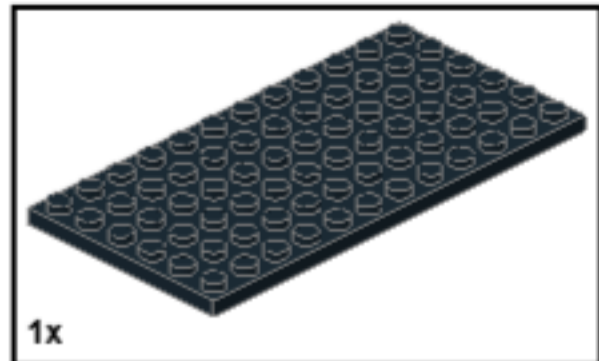

3

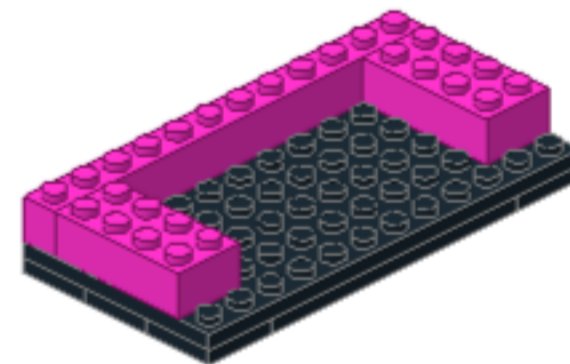
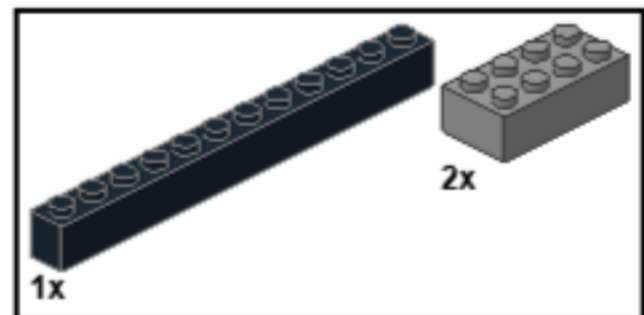

4

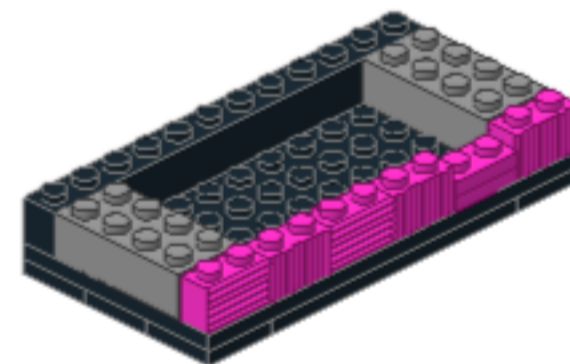
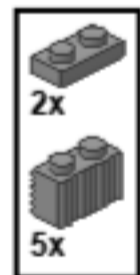

5

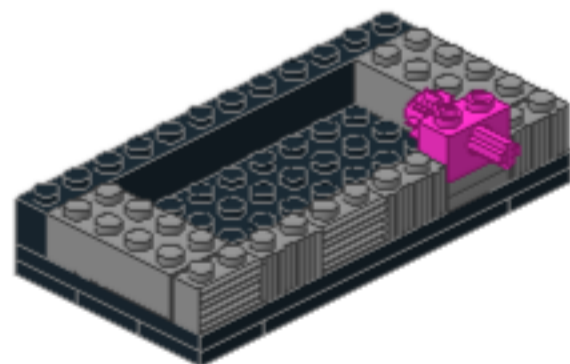
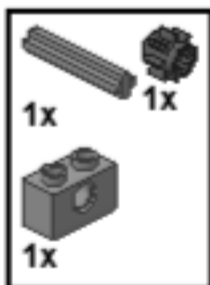

6

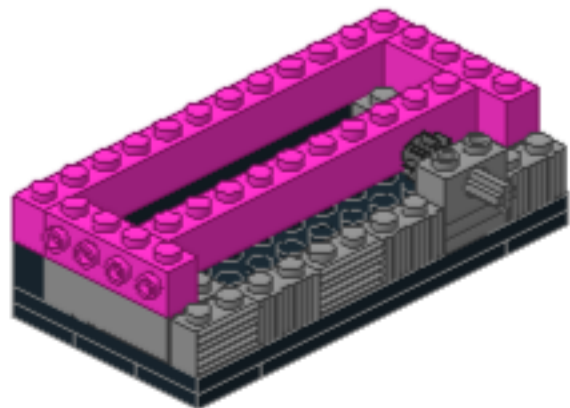
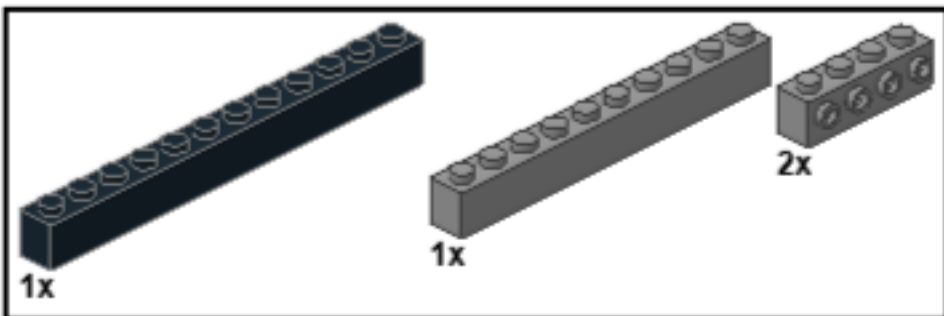

7

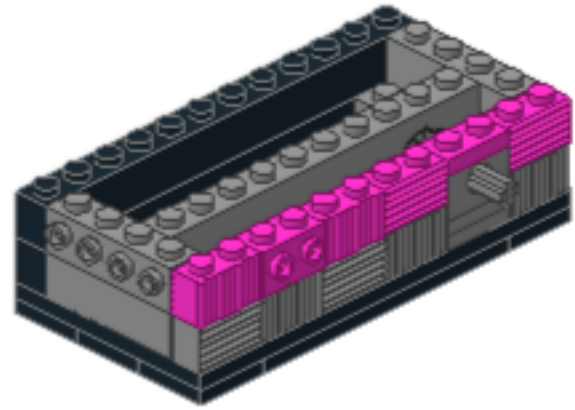
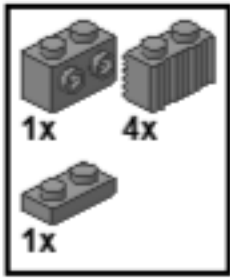

8

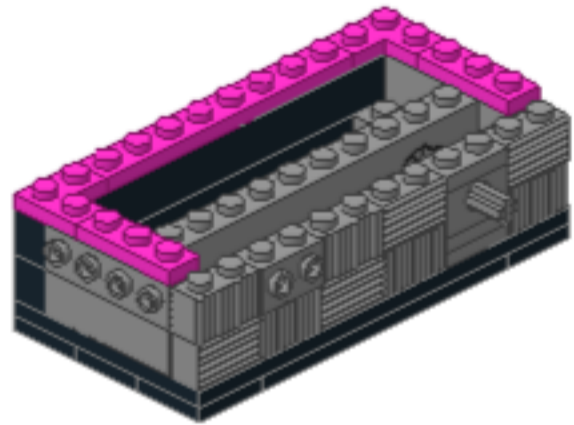
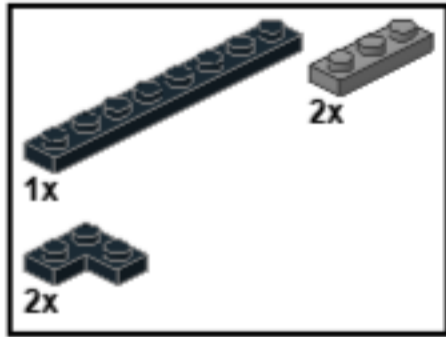

9

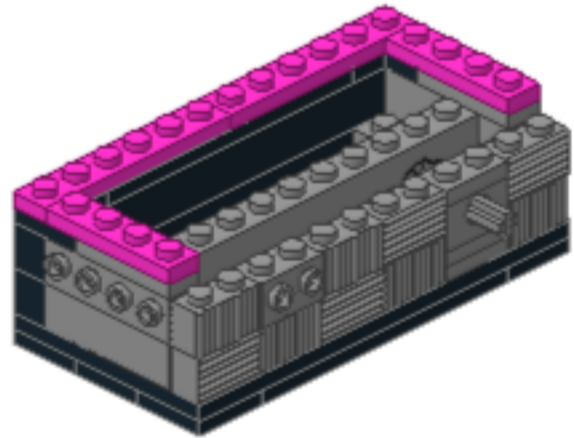
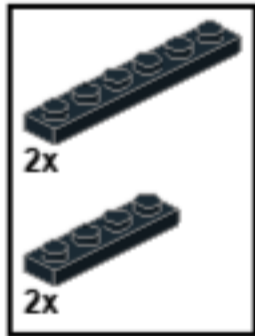

10

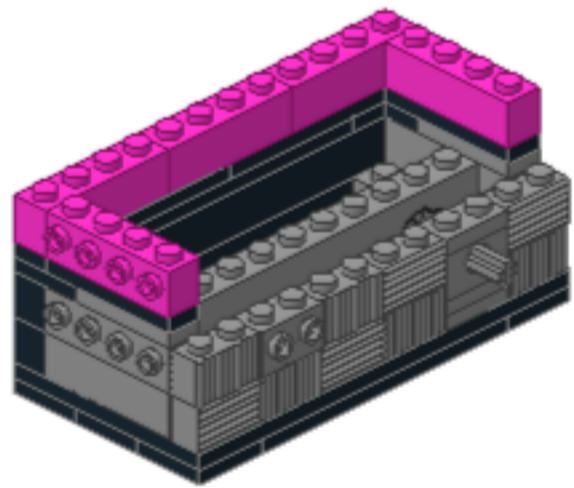
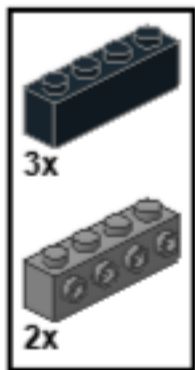

11

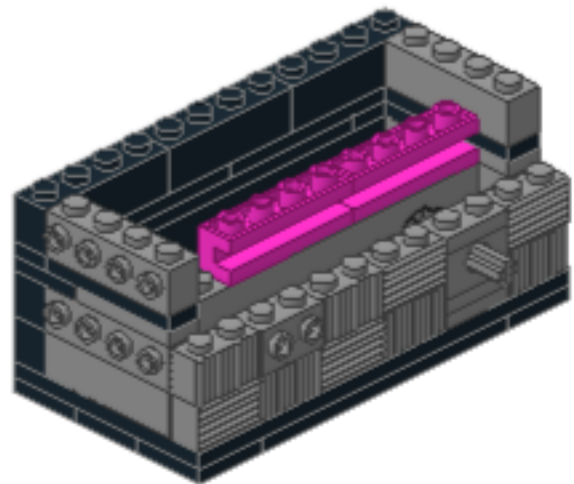
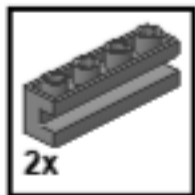

# 12

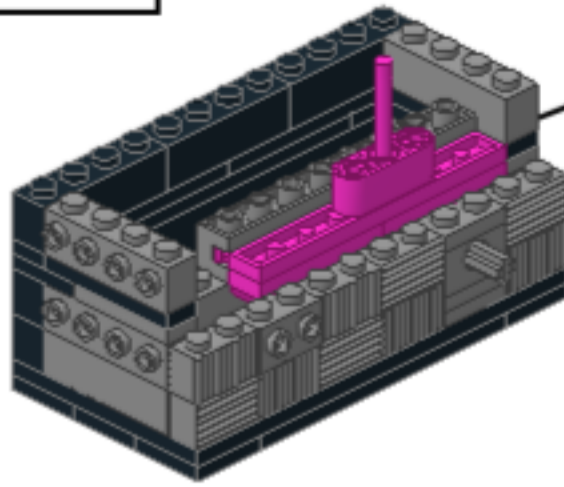
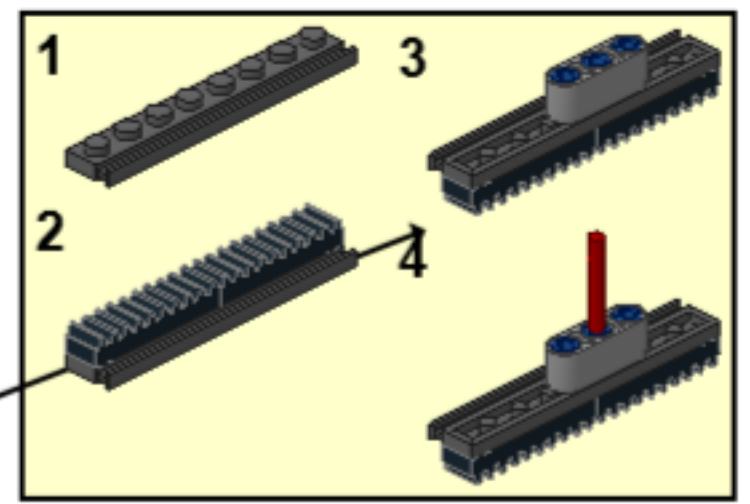
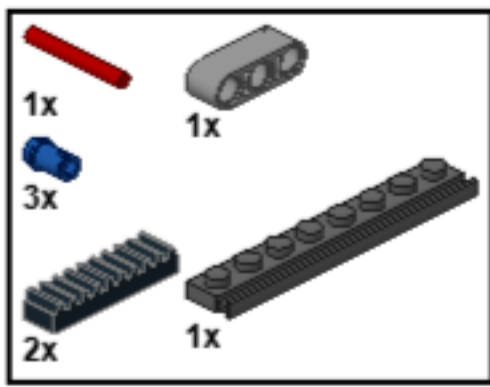

# 13

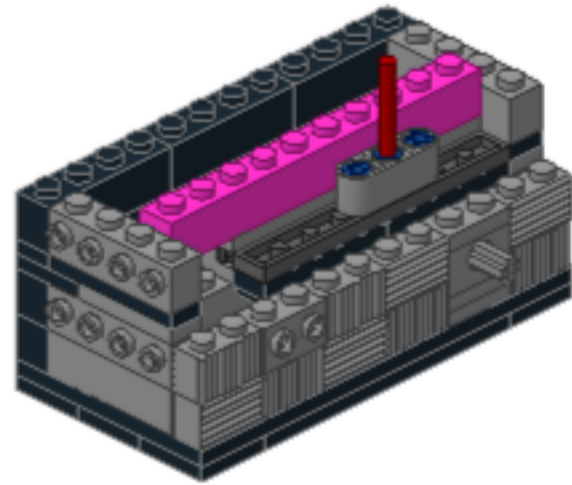
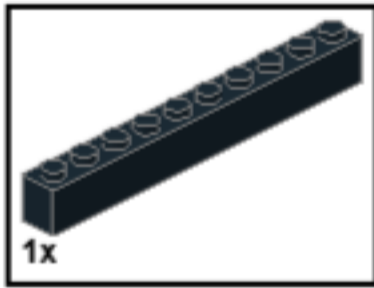

# 14

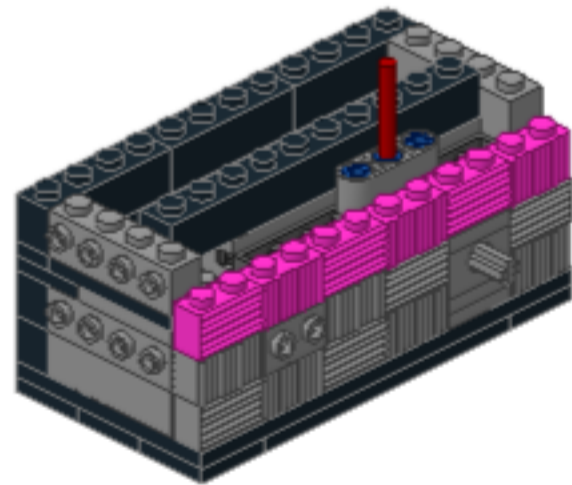

# 15

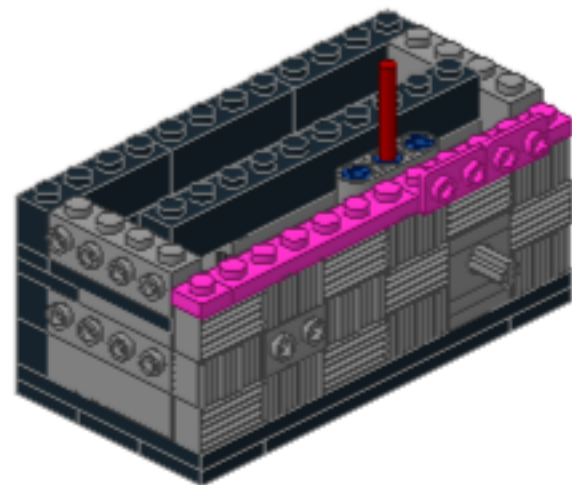
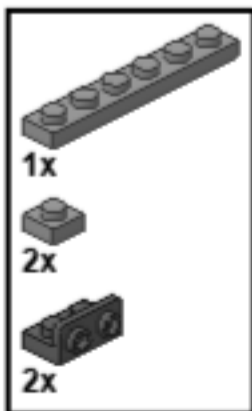

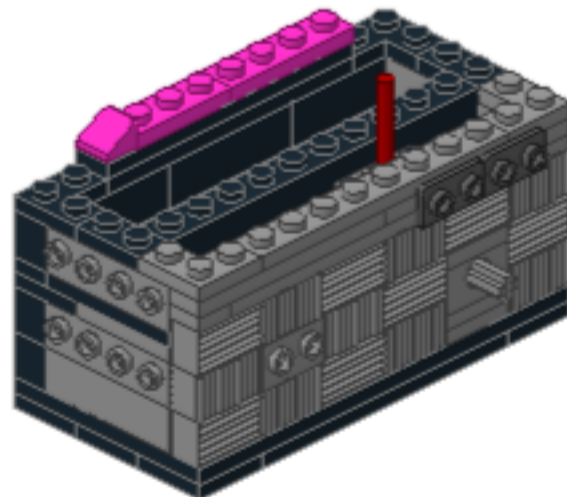
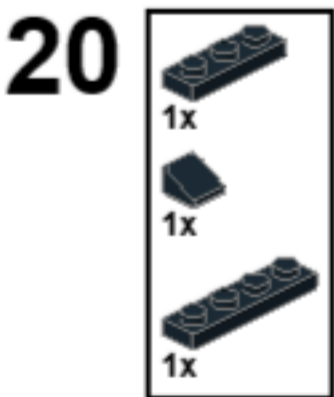
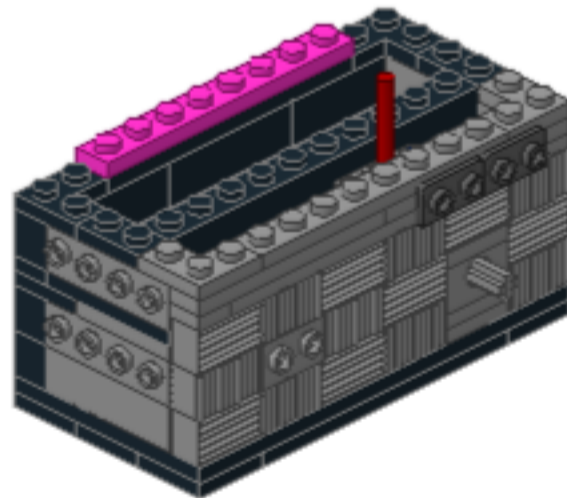
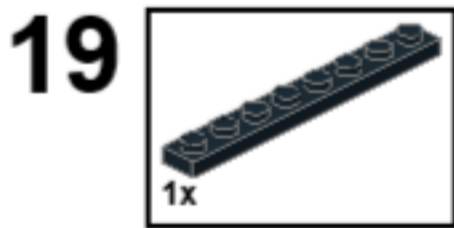
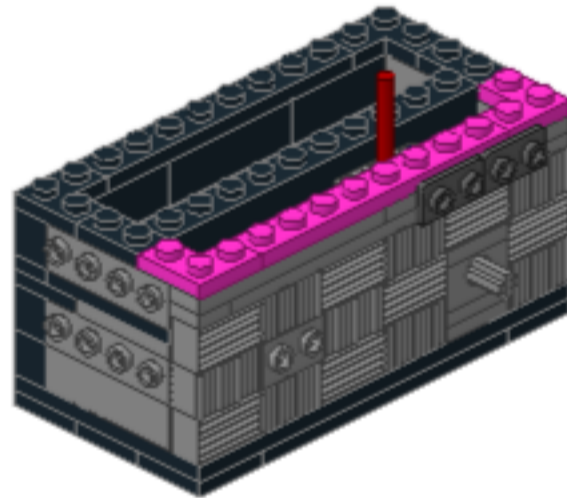
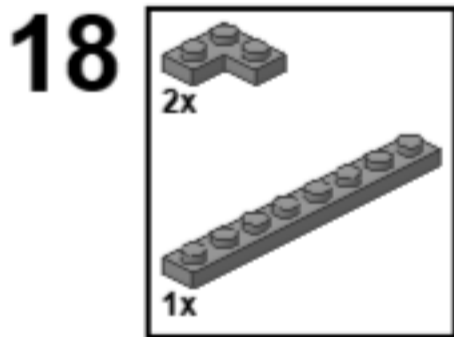
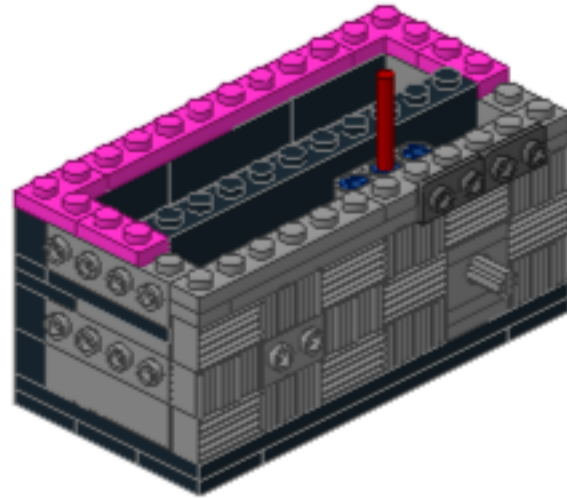
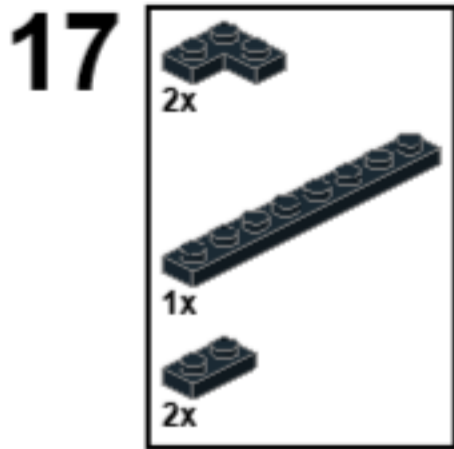
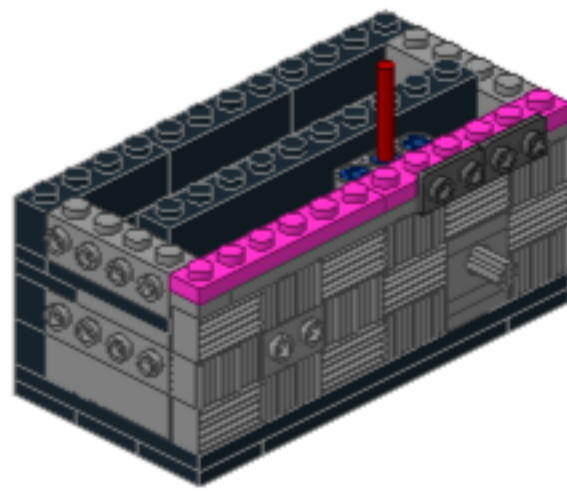
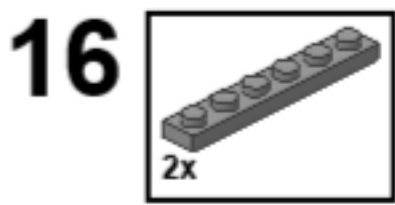

21

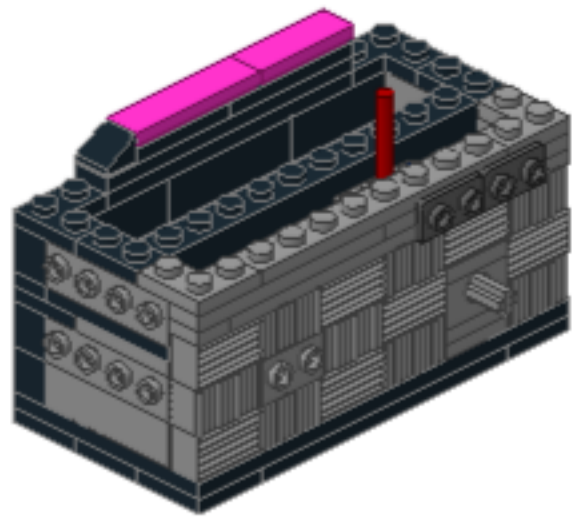
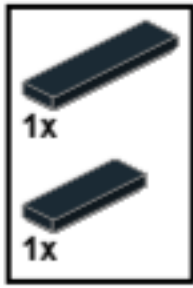

22

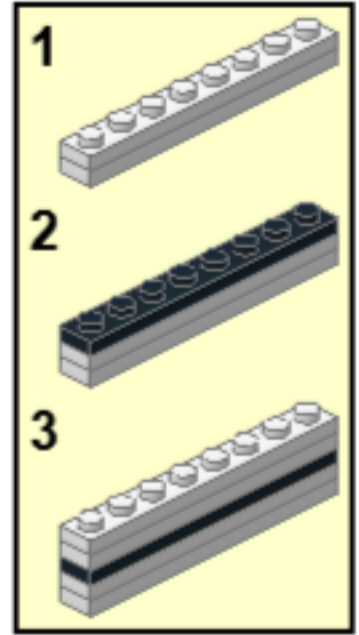
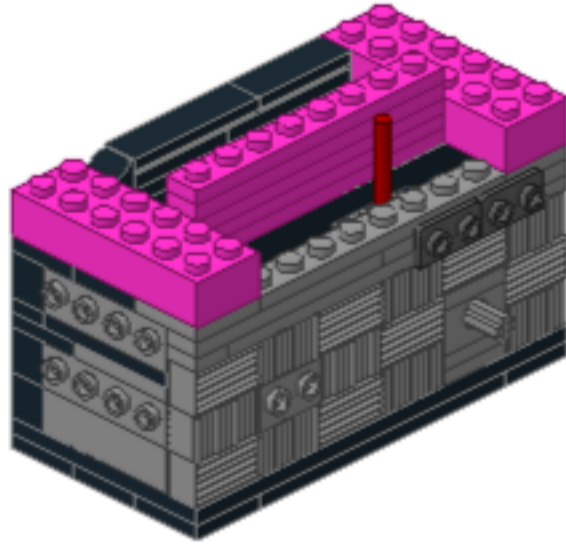
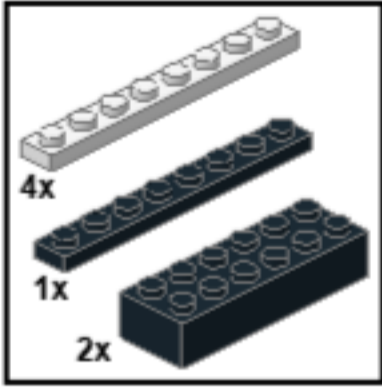

23

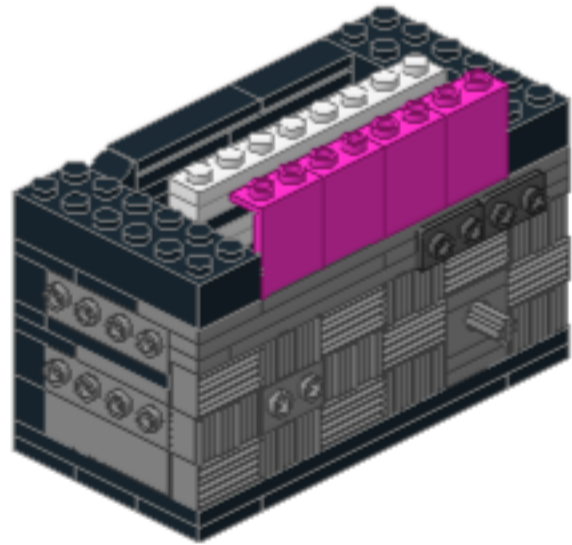

24

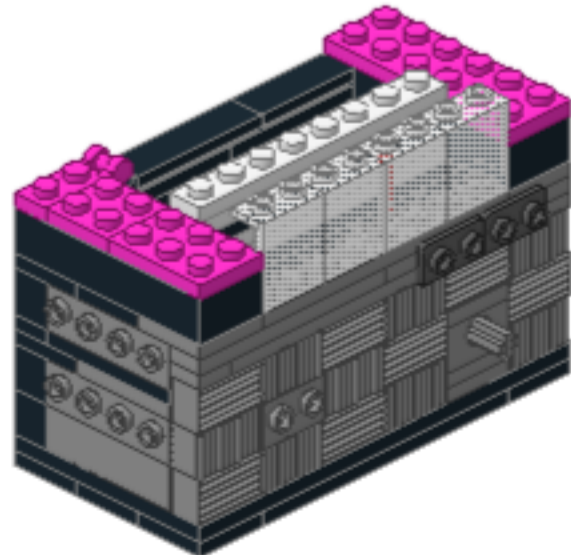
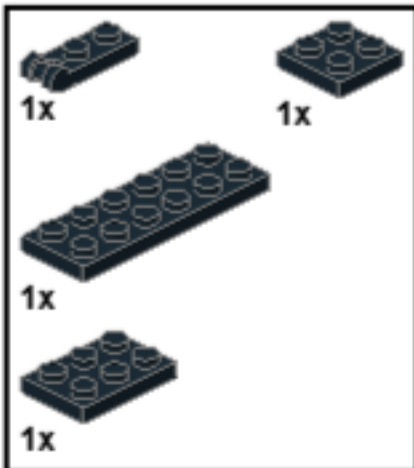

25

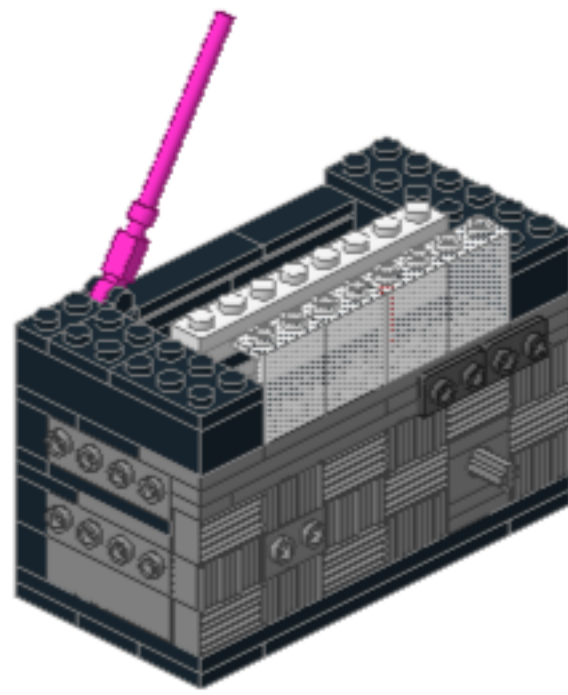
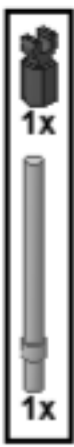

26

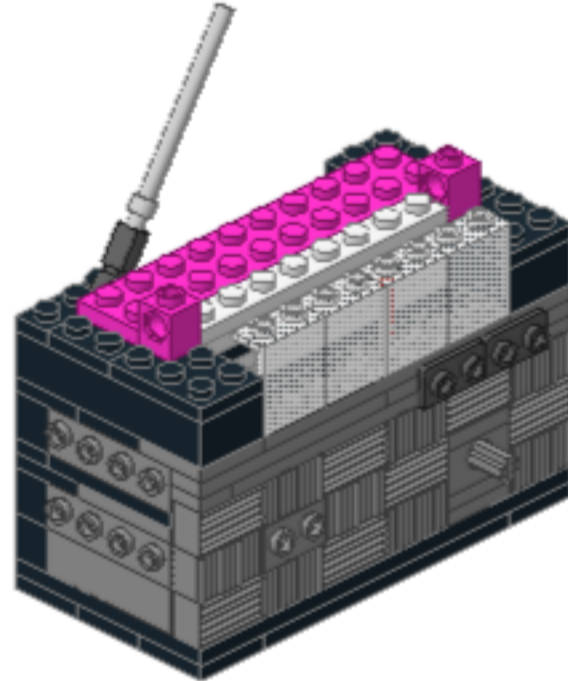
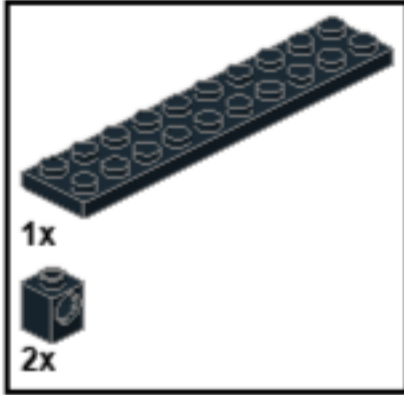

27

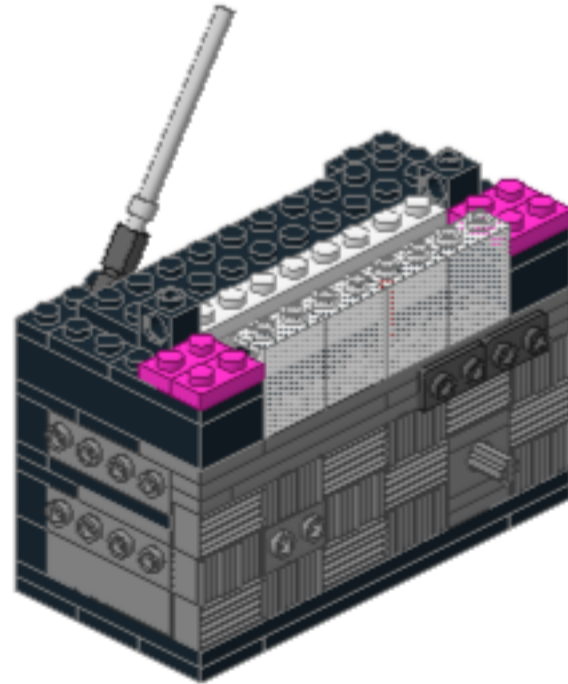

28

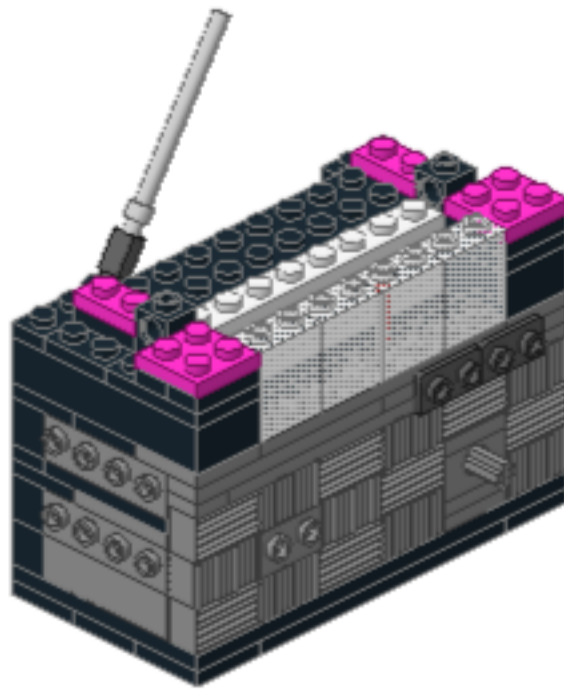
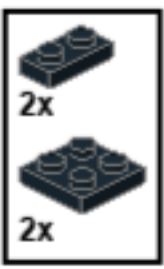

29

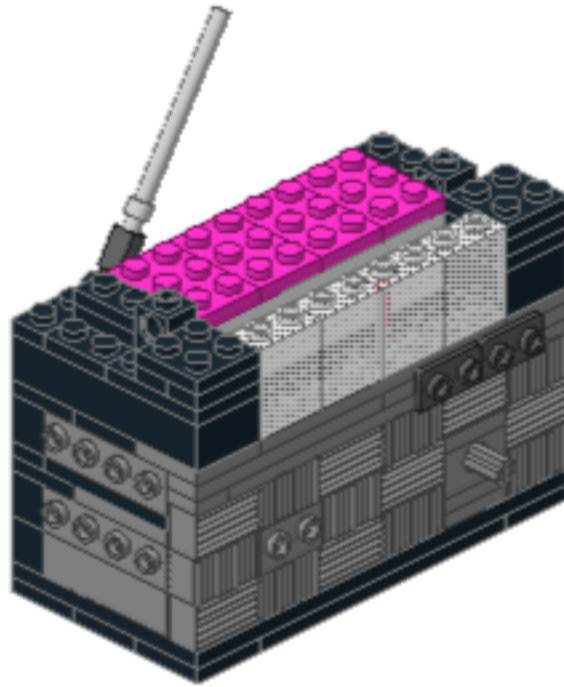
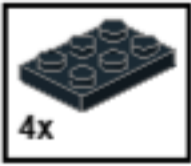

30

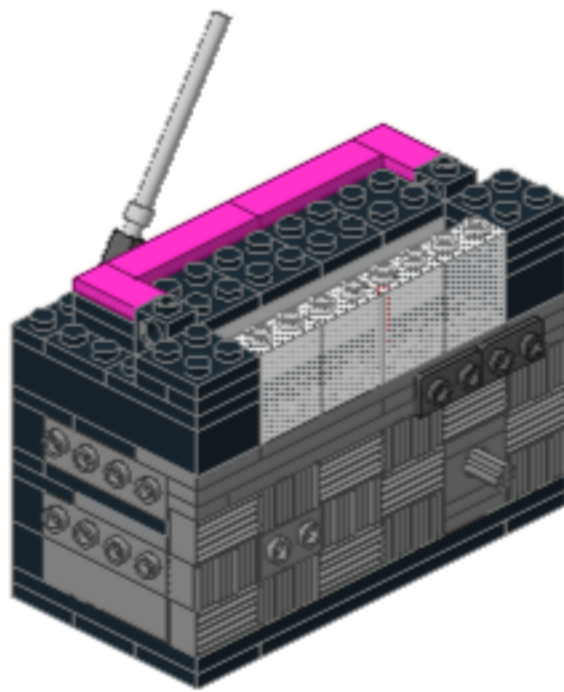
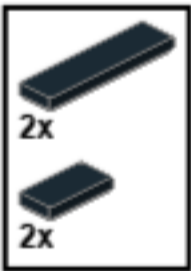

31

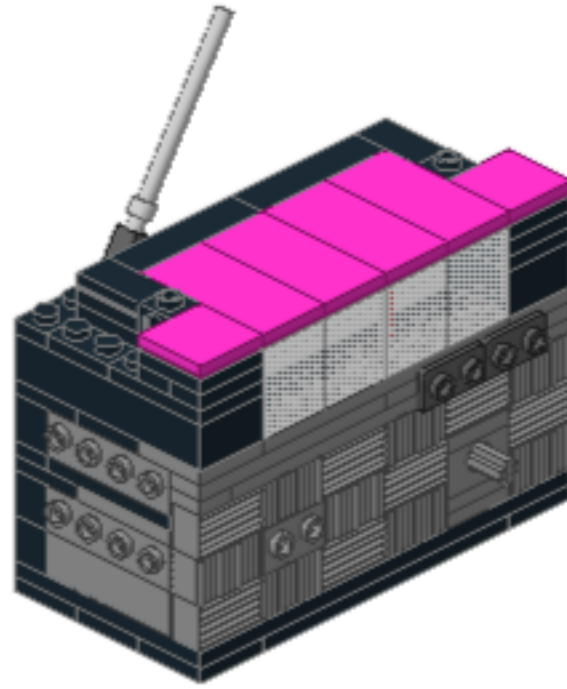
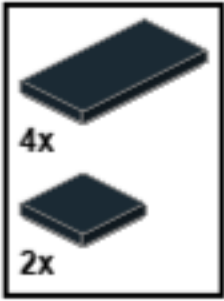

32

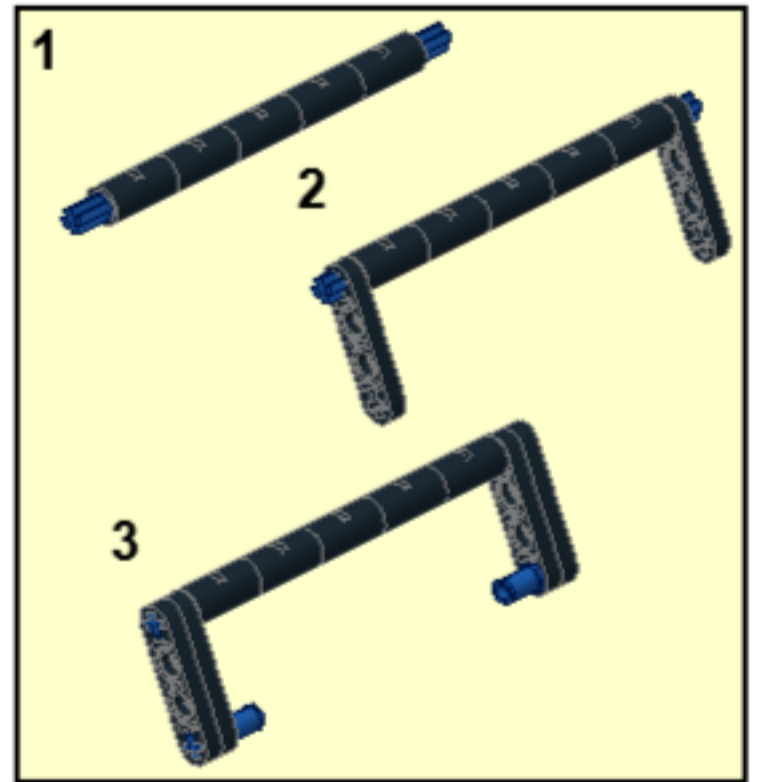
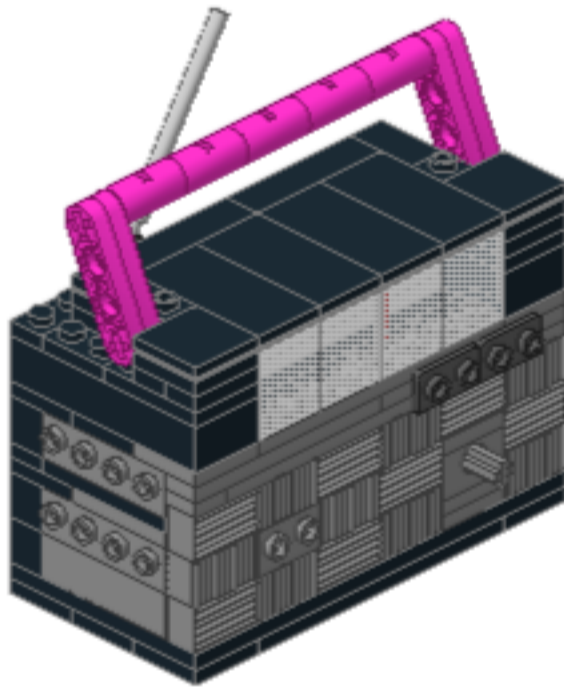

33

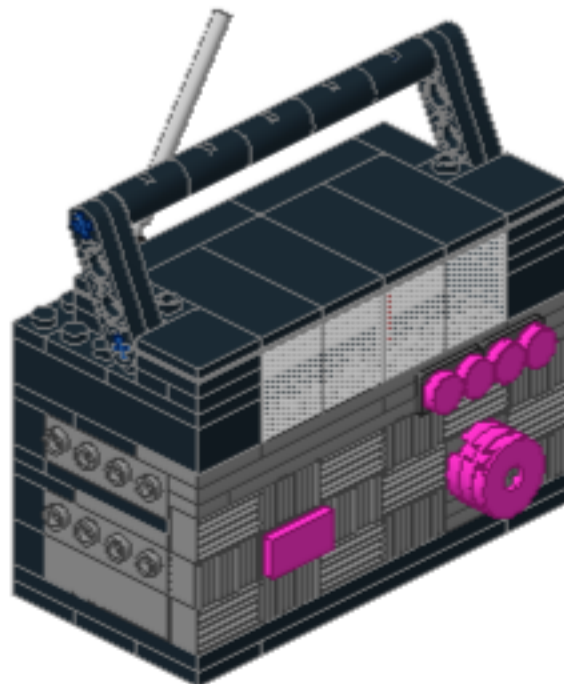
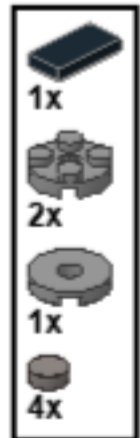



# 34

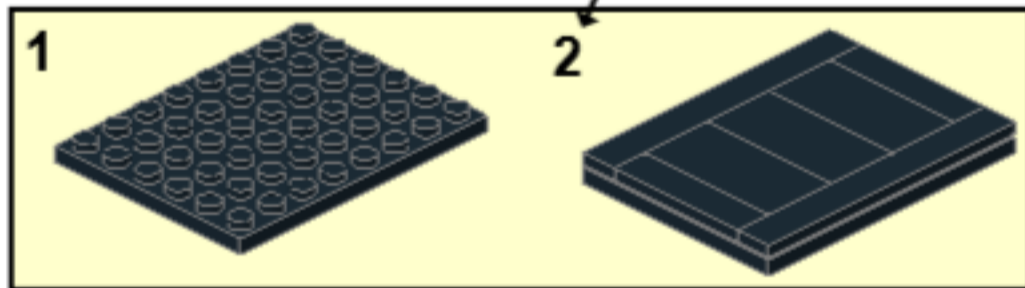
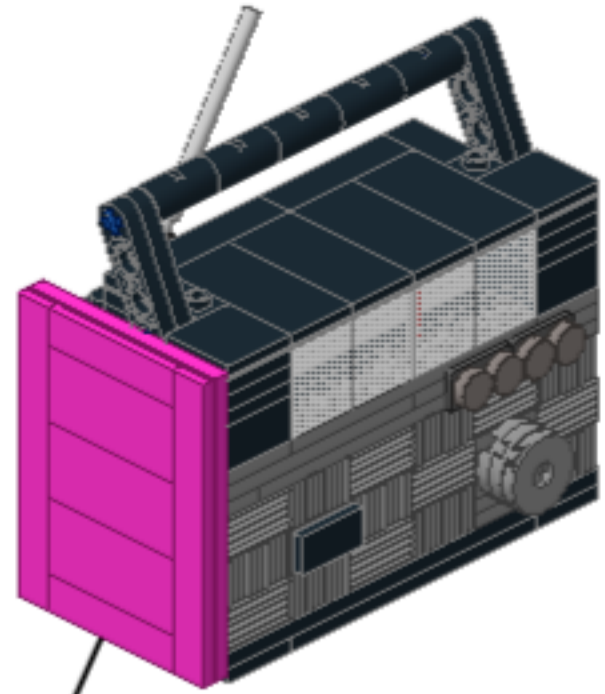
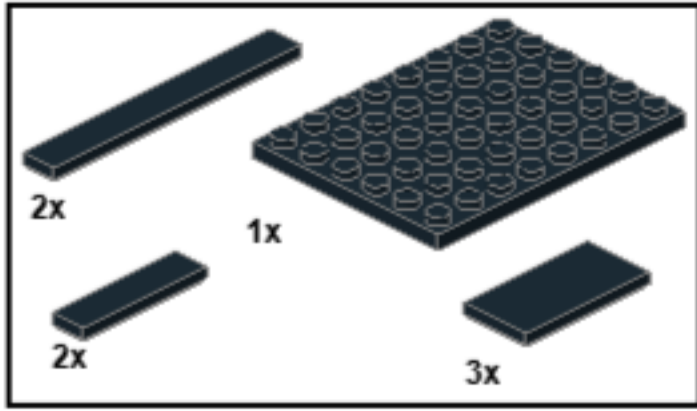

# 35

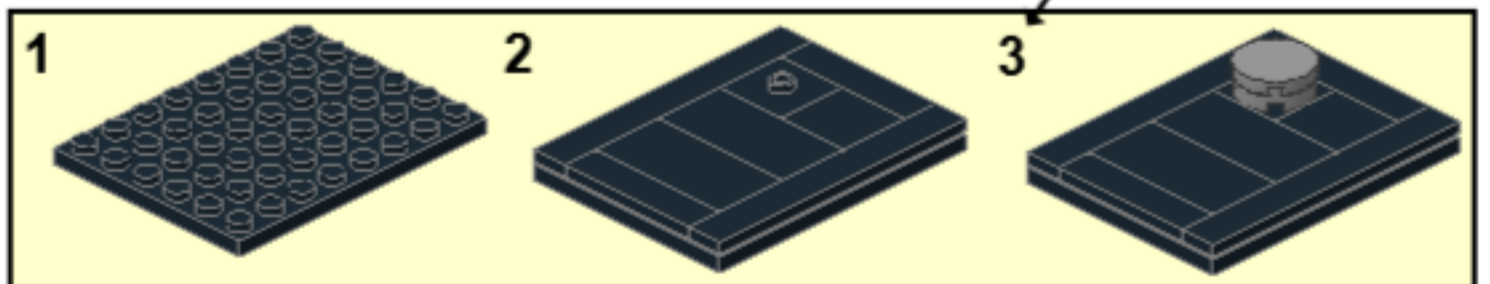
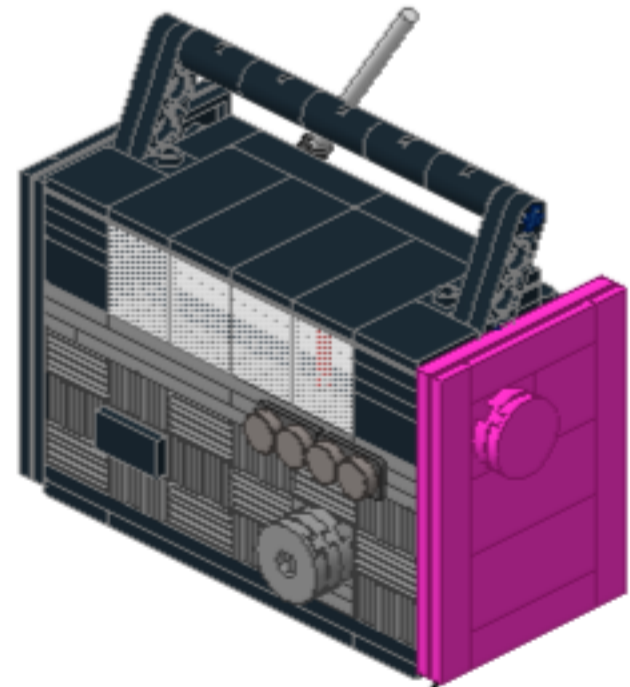
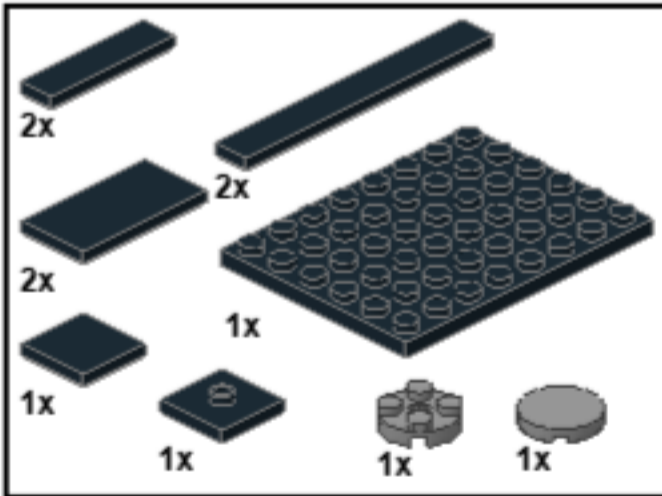

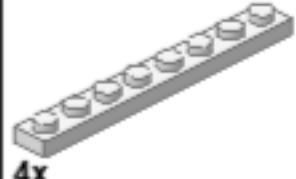

4x



1x



1x



3x



3x



5x

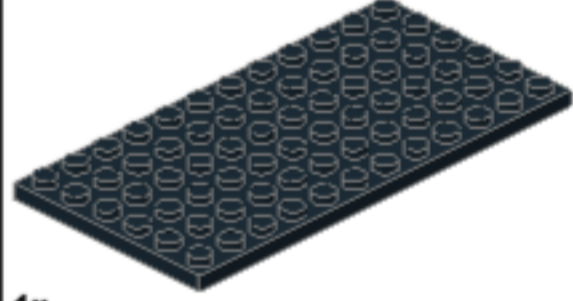

1x



3x



1x



1x



1x



2x



3x



5x



9x



4x



2x



1x



7x



2x



3x

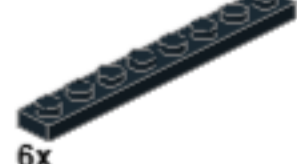

6x

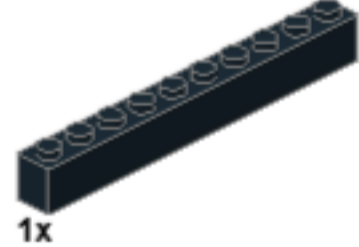

1x



4x

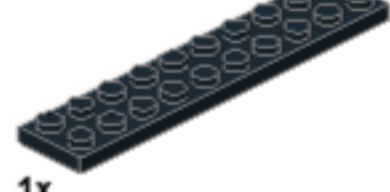

1x

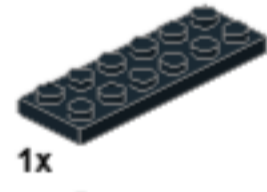

1x



3x



8x



10x

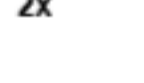

2x



2x



1x



3x



1x



4x



2x

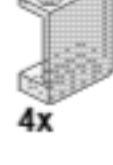

4x

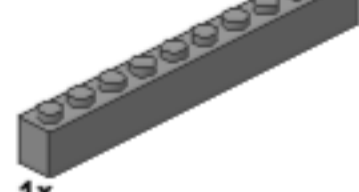

1x



3x

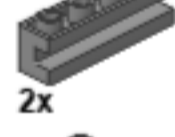

2x



1x



2x



3x

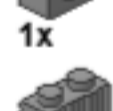

1x



15x



2x



1x



3x



2x



1x



1x



1x



2x

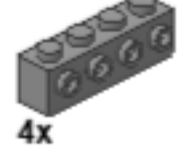

4x

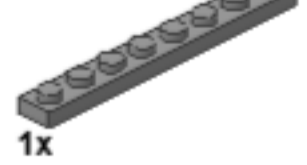

1x

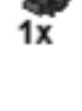

1x



1x

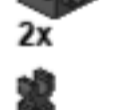

2x



1x



1x



4x